



INCASSO

SCEGLI IL TUO STILE PROMO SMEG DESIGN 2023

VALIDO DAL 01-10-2023 AD AGGIORNAMENTO LISTINI

 **smeg**
tecnologia che arreda



REGISTRATI SUL NOSTRO SITO

INCASSO

PRODOTTI -

MARCHI

CATALOGHI -

EVENTI E NEWS -



CLICCA QUI PER ACCEDERE

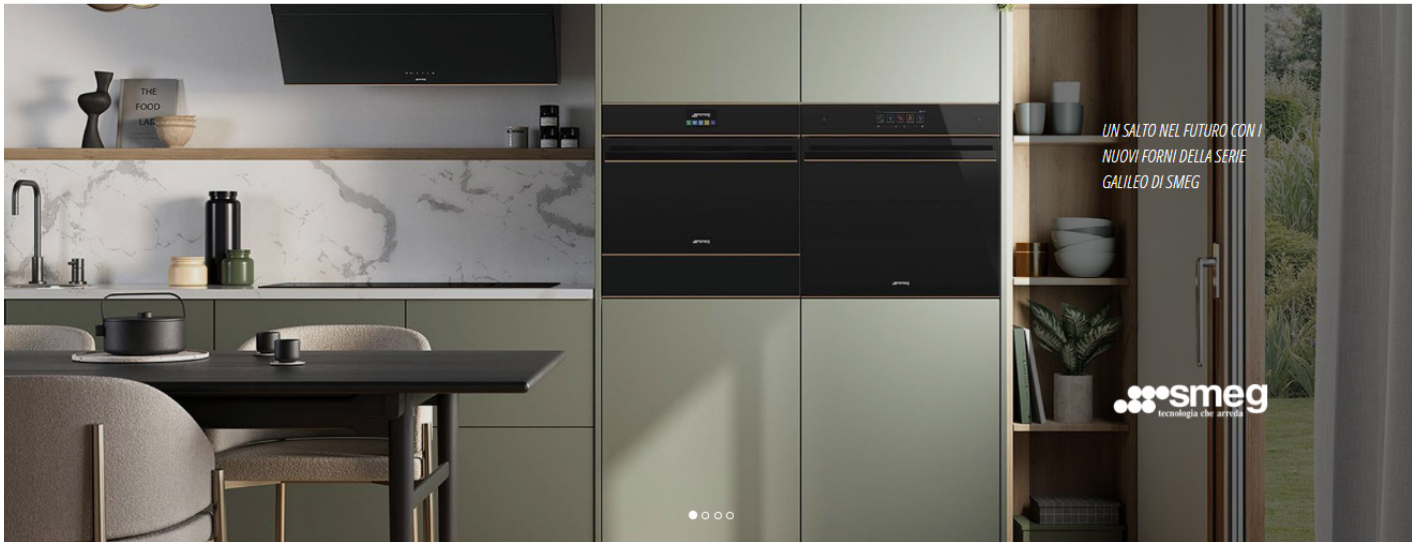

VISITA IL SITO WWW.INCASSO.IT PER RESTARE SEMPRE AGGIORNATO SU PRODOTTI E PREZZI. EFFETTUA L'ACCESSO ALLA TUA AREA RISERVATA PER EFFETTUARE E GESTIRE I TUOI ORDINI E FARE PREVENTIVI PERSONALIZZATI PER I TUOI CLIENTI.

ACCEDI O REGISTRATI

LOGIN

Se sei un utente registrato e possiedi un indirizzo email e una password personale, inseriscili per effettuare il login

RECUPERA PASSWORD

Hai dimenticato la password? [Clicca qui](#)

Mail

Password

Login

SEI UN NUOVO CLIENTE?

Per poter effettuare gli acquisti on-line è necessario richiedere l'iscrizione al nostro sito e alla lista dei nostri clienti. [Clicca sul bottone sottostante per effettuare la richiesta](#)

[Clicca qui per richiedere l'iscrizione](#)

NUOVO CLIENTE

CLICCA QUI PER PROCEDERE ALL'ISCRIZIONE INSERENDO TUTTI I DATI RICHIESTI DAL FORM PER POTER ACCEDERE ALLA SEZIONE DEDICATA

SEI GIÀ UN NOSTRO CLIENTE?

Se sei già un cliente di Incasso ma devi ancora effettuare la registrazione al nostro portale, [clicca sul bottone sottostante e procedi alla registrazione](#)

[Clicca qui per effettuare la registrazione](#)

CLIENTE GIÀ INSERITO

CLICCA QUI PER OTTENERE LE CREDENZIALI DI ACCESSO PER LA TUA AREA RISERVATA

PER ULTERIORE ASSISTENZA O INFORMAZIONI SULLA PROCEDURA DI REGISTRAZIONE CHIAMARE IL NUMERO 011.9279570 E CHIEDERE DI BENZO ELENA



MADE IN ITALY

Da 70 anni, Smeg, nata a Guastalla in Emilia Romagna, interpreta le esigenze dell'abitare contemporaneo per creare elettrodomestici che da semplici oggetti per la cucina diventano veri e propri elementi d'arredo ed espressione indiscussa del miglior design italiano.

Grazie a un'attenzione estrema alla qualità, alla funzionalità, all'estetica e all'ergonomia, Smeg è diventata eccellenza del Made in Italy che esporta con orgoglio la creatività, lo stile e la passione italiana in tutto il mondo.

<u>DOLCE STIL NOVO</u>	pag. 4
<u>LINEA NEPTUNE GREY</u>	pag. 6
<u>LINEA DEEP BLACK</u>	pag. 8
<u>LINEA CLASSICA</u>	pag. 10
<u>LINEA VICTORIA</u>	pag. 12
<u>LINEA PORTOFINO - CUCINE E CAPPE</u>	pag. 14
<u>LINEA VICTORIA - CUCINE E CAPPE</u>	pag. 15
<u>ESTETICA ANNI '50</u>	pag. 16
- Frigo monoporta	pag. 20
- Frigo monoporta Decor	pag. 22
- Frigo doppia porta	pag. 26
- Frigo combinati 60 cm	pag. 28
- Frigo combinati 70 cm	pag. 30
- Frigo doppia porta 80 cm	pag. 32
- Frigo sottotavolo	pag. 34
- Happybar	pag. 36
- Minibar	pag. 37
- Lavastoviglie	pag. 38
<u>PED - ESTETICA ANNI '50</u>	pag. 40
<u>PENTOLE</u>	pag. 74
<u>ACCESSORI PED</u>	pag. 76

FORNI | h. 60 cm

OMNICHIEF ●●●	STEAM100 PRO ●●●	PYROSTEAM ●●●	STEAM100 PRO ●●●	PYROSTEAM ●●●		
						
SO6606WAPNR <i>combinato, vapore, microonde</i>	SO6606WS4PNR <i>combinato vapore</i>	SOP6606WS2PNR <i>combinato vapore, pirolitico</i>	SO6604S4PNR <i>combinato vapore</i>	SOP6604S2PNR <i>combinato vapore, pirolitico</i>	SOP6604TPNR <i>termoventilato, pirolitico</i>	SOP6602TNR <i>termoventilato, pirolitico</i>

FORNI | h. 45 cm, 38 cm

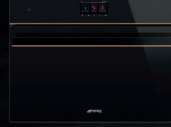
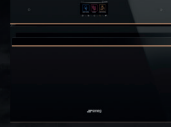
OMNICHIEF ●●●	STEAM100 PRO ●●●	SPEEDWAVE ●●●	STEAM100 PRO ●●●			
						
SO4606WAPNR <i>combinato, vapore, microonde</i>	SO4606WS4PNR <i>combinato vapore</i>	SO4606WM2PNR <i>combinato microonde</i>	SO4604S4PNR <i>combinato vapore</i>	SF4604WMCNR <i>combinato microonde</i>	SO4602M1NR <i>combinato microonde</i>	FMI625CN <i>combinato microonde</i>

FORNI | L. 90 cm



SFPR9606TPNR
termoventilato, pirolitico



SFPR9604TNR
termoventilato, pirolitico

ALTRI PRODOTTI | h. 45 cm, 15 cm



CMS4604NR
macchina caffè



SBC4604WNR
abbattitore di temperatura



CPRT615NR
cassetto riscaldante



CPV615NR
cassetto sottovuoto



CPS615NR
cassetto sommelier

Vitality System

CANTINE VINI | h. 45 cm, 60 cm, 82 cm



CVI621NR3
cantina vini, cerniere reversibili



CVI629NR3
cantina vini, cerniere reversibili



CVI638RN3
cantina vini, cerniere a destra



CVI638LN3
cantina vini, cerniere a sinistra

PIANI DI COTTURA A INDUZIONE | L. 90 cm, 80 cm, 60 cm



SIM6964R
90 cm, 3 aree multizone



SIM6864R
80 cm, 3 aree multizone



SIM6644R
60 cm, 2 aree multizone



SIM6323R
38 cm, 1 area multizone

PIANO CON CAPPA | L. 90 cm



HOB682R1
90 cm, induzione multizone con cappa integrata



KD694R
90 cm, a parete

PIANI DI COTTURA BRUCIATORI LAMINARI | L. 100 cm, 75 cm, 60 cm



PXL6106
100 cm inox

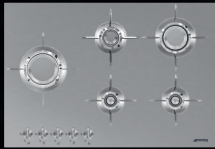

PXL675L
75 cm inox



PXL664
60 cm inox



PVL6106CN
100 cm vetroceramico nero



PVL675LCN
75 cm vetroceramico nero



PVL664CN
60 cm vetroceramico nero

PIANI A GAS | L. 90 cm, 75 cm, 60 cm, 38 cm



PV695LCNR
90 cm, gas



PV675CNR
75 cm, gas



PV664LCNR
60 cm, gas



PV632CNR
38 cm, gas

Dolce Stil Novo

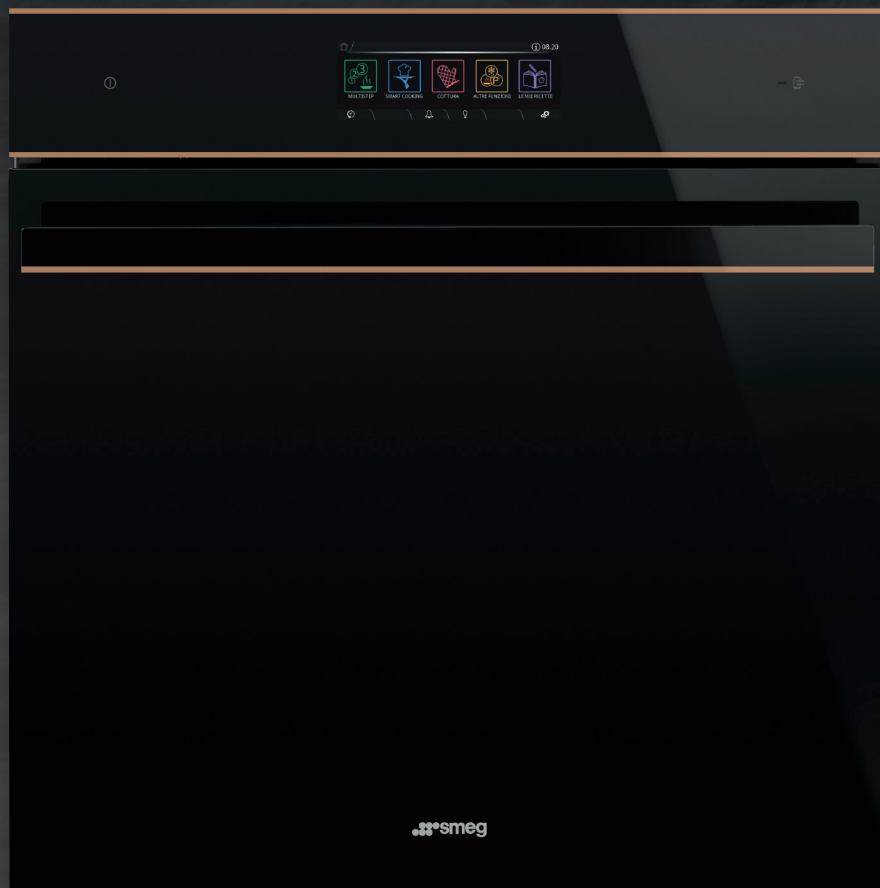

In un design che porta gli opposti ad incontrarsi
- il buio si fa luce, la funzionalità si fonde per diventare estetica -
Dolce Stil Novo presenta innovazioni progettuali e stilistiche che
impreziosiscono i prodotti in gamma, rendendoli punto focale
dello spazio in cui vengono inseriti.



FORNI | h. 60 cm

OMNICHEF ●●●

STEAM100 PRO ●●●

PYROSTEAM ●●●

PYRO ●●



SO6104APG
combinato vapore,
microonde



SO6104S4PG
combinato vapore



SOP6104S2PG
aggiunta vapore,
pirolitico



SOP6104TPG
termoventilato, pirolitico

STEAM100 ●●●

PYROSTEAM ●●●

SPEEDWAVEXL ●●●

PYRO ●●



SO6102S3PG
combinato vapore



SOP6102S2PG
aggiunta vapore, pirolitico



SO6102M2G
combinato microonde



SOP6102TG
termoventilato, pirolitico



SO6102TG
termoventilato

FORNI | h. 45 cm

OMNICHEF ●●●

STEAM100 PRO ●●●

SPEEDWAVE ●●●



SO4104APG
combinato vapore,
microonde



SO4104S4PG
combinato vapore



SO4104M2PG
combinato microonde



SO4102M1G
combinato microonde



SBC4104G
abbattitore di temperatura



CPV115G
cassetto sottovuoto

ALTRI PRODOTTI | h. 45 cm, 38 cm, 15 cm



CMS4104G
macchina caffè



FMI125G
microonde con grill



FMI120G
microonde con grill



CPRT115G
cassetto riscaldante



KV194G
cappa a parete

PIANI INDUZIONE | L. 90 cm, 80 cm, 60 cm



SIA1963DG
piano AREA, 90 cm
display TFT touch a colori



SIM1964DG
90 cm, 3 aree multizone



SIM1864DG
80 cm, 3 aree multizone



SIM1844DG
80 cm, 1 area multizone,
2 zone singole



SIM1644DG
60 cm, 2 aree
multizone

CANTINE VINI | h. 82 cm, 60 cm, 45 cm, 15 cm



CVI138LG
cantina vini sottotop,
cerniere a sinistra



CVI138RG
cantina vini sottotop,
cerniere a destra



CVI129G
cantina vini,
cerniere reversibili



CVI121G
cantina vini,
cerniere reversibili



CPS115G
cassetto sommelier

VITALITY SYSTEM | h. 45 cm, 15 cm



CAPPA A PARETE | L. 90 cm

Linea

Neptune Grey



Equilibrio ed ergonomia per massimizzare lo spazio.
Linea è l'estetica caratterizzata da uno stile minimalista e un design
volto a sfruttare tutto lo spazio disponibile.
Elementi distintivi sono la luce, la linearità, l'uniformità, l'ergonomia che
interpretano al meglio le più attuali tendenze del design.

FORNI | h. 60 cm

STEAM100 ●●

PYROSTEAM ●●

SPEEDWAVEXL ●●●



SO6102S3PB3
combinato vapore



SOP6102S2PB3
aggiunta vapore,
pirolitico



SO6102M2B3
combinato microonde



SOP6102TB3
termoventilato, pirolitico



SO6102TB3
termoventilato

PYROSTEAM ●●

STEAMONE ●●



SOP6101S2B3
aggiunta vapore, pirolitico



SO6101S2B3
aggiunta vapore



SFP6101TB3
termoventilato, pirolitico



SF6101TB3
termoventilato



SF6100VB3
ventilato

FORNI | h. 45 cm

MICROONDE, CASSETTO | h. 38 cm, 15 cm

STEAM100 ●●



SO4102S3B3
vapore combinato



SO4102M1B3
microonde combinato



FMI125N
microonde con grill



FMI120B3
microonde con grill



MP122B3
microonde con grill



CPRT115B3
cassetto riscaldante

FORNO | L. 75 cm

CAPPE A PARETE | L. 90 cm, 80 cm, 60 cm



SO5100TB3
termoventilato



KV194B3
90 cm, a parete



KV28N
80 cm, a parete

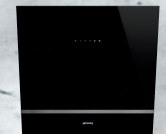

KV26N
60 cm, a parete

PIANO INDUZIONE | L. 90 cm, 80 cm, 60 cm

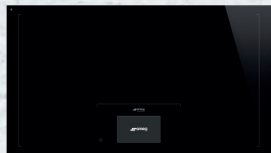

SIA1963D
90 cm, piano AREA,
display TFT touch a colori

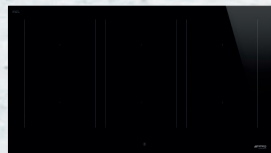

SIM3964D
90 cm, 3 aree multizone



SIM3864D
80 cm, 3 aree multizone

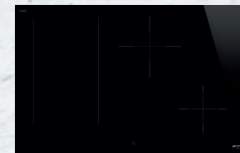

SIM3844D
80 cm, 1 area multizone,
2 zone singole



SIM3644D
60 cm, 2 aree
multizone

CANTINE VINI | h. 82 cm, 60 cm, 45 cm, 15 cm



CVI638RN3
cantina vini sottotop,
cerniere a destra
CVI638LN3
cerniere a sinistra



CVI129B3
cantina vini 60 cm

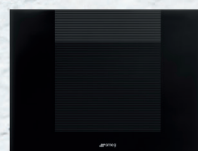

CVI121B3
cantina vini 45 cm



CPS115B3
cassetto sommelier

PIANI A GAS | L. 75 cm, 60 cm



PV175B3
75 cm gas



PV164B3
60 cm gas

Linea Deep Black



Equilibrio ed ergonomia per massimizzare lo spazio.
Linea è l'estetica caratterizzata da uno stile minimalista e un design
volto a sfruttare tutto lo spazio disponibile.
Elementi distintivi sono la luce, la linearità, l'uniformità, l'ergonomia che
interpretano al meglio le più attuali tendenze del design.

FORNI h. 60 cm

OMNICHIEF ●●●●



SO6303APX
combinato, vapore,
microonde

STEAM100 ●●●



SO6302S3PX
combinato vapore

PYROSTEAM ●●●



SOP6302S2PX
combinato vapore,
pirolitico

SPEEDWAVEXL ●●●●



SO6302M2X
combinato microonde



SOP6302TX
termoventilato, pirolitico



SO6302TX
termoventilato

PYROSTEAM ●●●



SOP6301S2X
combinato vapore,
pirolitico

STEAMONE ●●●



SO6301S2X
combinato vapore



SFP6301TVX
termoventilato, pirolitico



SF6301TVX
termoventilato



SF6381X
ventilato

FORNI h. 45 cm



SO4302S3X
combinato vapore



SF4390MCX
combinato microonde



SF4301MCX
vcombinato vapore



SF4301MX
combinato microonde



MP322X1
microonde



FMI325X
microonde



FMI320X2
microonde

FORNI | L. 90 cm



SFR9390X
ribassato, termoventilato, pirolitico



SFR9395X1
termoventilato, pirolitico

ALTRI PRODOTTI | h. 45 cm, 15 cm



CMS4303X
macchina caffè



SBC4304X
abbattitore
di temperatura



CPR315X
cassetto riscaldante



CPV315X
cassetto sottovuoto

CANTINE VINI | h. 45 cm, 60 cm, 82 cm



CVI321X3
cantina vini,
cerniere reversibili



CVI329X3
cantina vini,
cerniere reversibili

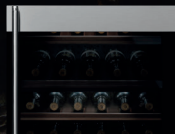

CVI338RX3
cantina vini,
cerniere a destra
CVI338LX3
cantina vini,
cerniere a sinistra



Vitality System

PIANI A GAS | L. 90 cm, 75 cm, 65 cm, 30 cm



PV395LN
90 cm vetroceramico nero



PV375N
75 cm vetroceramico nero



PV364N
65 cm vetroceramico nero



PV332CN
30 cm vetroceramico nero



PV331CN
30 cm vetroceramico nero

PIANI MISTI GAS-INDUZIONE | L. 90 cm, 75 cm, 65 cm



PX375L
70/75 cm inox



PX375
70/75 cm inox



PX364L
60 cm inox



PM3953D
90 cm, misto gas-induzione



PM3743D
75 cm, misto gas-induzione

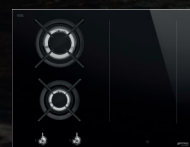

PM3643D
60 cm, misto gas-induzione



Classica Inox



Classica Matt Black

FORNI, CASSETTO | h. 60 cm, h. 45 cm, 15 cm

PIANI A GAS | h. 75 cm, h. 60 cm



SFP6301TVN
termoventilato, pirolitico



SF6301TN
termoventilato



SO4301MON
microonde con grill

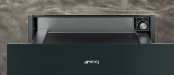

CPR315N
cassetto riscaldante



PX375LMB
75 cm
ultrarapido laterale
con doppio comando



PX375MB
microonde con grill



PX364LMB
60 cm

FORNI | h. 60 cm

PYROSTEAM ●●



SOP6902S2PN
combinato vapore,
pirolitico



SOP6900TN
termoventilato,
pirolitico

PYROSTEAM ●●



SOP6902S2PX
combinato vapore,
pirolitico

SMEG



SOP6900TX
termoventilato,
pirolitico

PYROSTEAM ●●



SOP6902S2PP
combinato vapore,
pirolitico



SOP6900TP
termoventilato,
pirolitico



SF6905N1
termoventilato



SF6905X1
termoventilato



SF6905P1
termoventilato

FORNI E CASSETTI | h. 45 cm, 15 cm



SO4902M1N
combinato microonde



CPR915N
cassetto riscaldante



SO4902M1X
combinato microonde



CPR915X
cassetto riscaldante



SO4902M1P
combinato microonde



CPR915P
cassetto riscaldante

PIANI A GAS | L. 75 cm, 60 cm



SR975NGH
75 cm nero



SR964NGH
60 cm nero



SR975XGH
75 cm inox



SR964XGH
60 cm inox

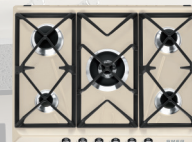

SR975PGH
75 cm panna



SR964PGH
60 cm panna

CAPPE | L. 110 cm, 100 cm, 90 cm



KT110BLE
110 cm, a parete



KT100BLE
100 cm, a parete



KTR110XE
110 cm, a parete



KT110PE
110 cm, a parete



KT100PE
100 cm, a parete



KT90BLE
90 cm, a parete



KT90XE
90 cm, a parete



KT90PE
90 cm, a parete

SMEG

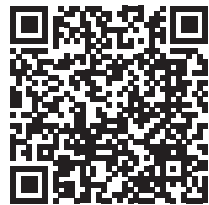

Victoria



Victoria è l'estetica dedicata a chi ama atmosfere calde ed avvolgenti tipiche di una casa di campagna in cui la passione per la buona tavola si esprime nella cura per i dettagli.



Portofino



Victoria



NUOVI modelli FAB28, FAB30 e FAB32



FAB28



FAB32

DETTAGLI ICONICI

Curve arrotondate e dettagli cromati coordinano perfettamente gli interni e la porta esterna del frigorifero.



FAB30

NUOVI INTERNI

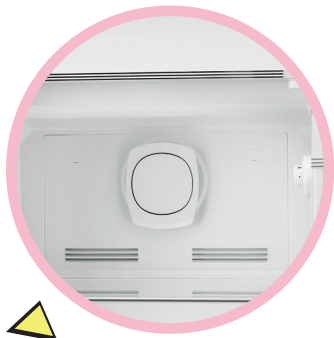

SISTEMA DI REFFREDDAMENTO MULTIFLOW

Distribuisce l'aria fredda in modo uniforme in tutto il frigorifero garantendo temperatura e umidità ideali per una corretta conservazione dei cibi.



CONTROLLO ELETTRONICO DELLA TEMPERATURA

Il termostato laterale consente di regolare e monitorare la temperatura interna elettronicamente o manualmente.



ELEGANTI FINITURE CROMATE

I profili dei balconcini e dei ripiani di cristallo sono disegnati con brillanti finiture cromate dal design retrò.



CASSETTO LIFE PLUS 0°C

Spazio di conservazione a una temperatura fra -2 e +3°C, ideale per il mantenimento dei cibi più deperibili come pesce e carne.

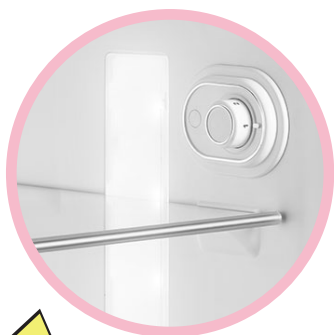

LUCI LED

L'illuminazione interna è rinnovata grazie alle nuove strisce di LED poste lungo entrambe le pareti del frigorifero.

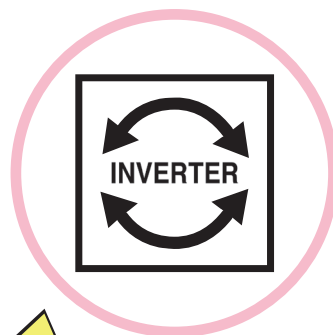

MOTORE INVERTER

Con il nuovo motore inverter, le prestazioni si elevano al top, con un risparmio di energia fino al 40%

NUOVI colori MATT



DETTAGLI ICONICI

La palette colori dell'iconico frigorifero FAB28 si arricchisce con 3 nuovi colori matt.

**SOFT
TOUCH**



Taupe



Ruby Red



Emerald Green

GRANDI CAPACITÀ



FAB50



no frost

larghezza
80cm

FAB50



**novità
FAB38**



no frost

larghezza
70cm

FAB38

FAB10 e FAB5 Minibar



FAB5



Prestazioni migliorate grazie alla nuova certificazione energetica per il nuovo Minibar FAB5. Ricco di performance e personalità in un irresistibile formato compatto, il FAB5 sfoggia le medesime forme sinuose e il fascino retrò dei FAB, icona di stile a livello internazionale.



FAB10



FAB10H



Sviluppato da un'intuizione che supera il tradizionale concetto di minifrigo, HAPPY BAR si presenta con un allestimento interno innovativo. Gli appositi inserti, studiati ad hoc per spumanti, aperitivi, bibite, drink e snack, permettono infatti una migliore fruibilità dello spazio rendendo questo prodotto altamente performante.

LINEA ANNI 50

FRIGORIFERI MONOPORTA

Frigorifero monoporta Estetica ANNI 50

Frigorifero monoporta 60 cm
Classe D
Frigorifero ventilato
Rumorosità: 38 dB(A)
Sbrinamento: Frigo automatico, freezer manuale
Mensole cassette e ripiani con profili cromati

VANO FRIGORIFERO:

Volume utile scomparto alimenti freschi: 223 l
Volume utile scomparto zero gradi: 21 l
1 cassetto frutta e verdura
1 ripiano regolabile in cristallo
1 Verduriera su guide scorrevoli
1 ripiano copriverduriere in cristallo
Vano Life Plus - 0°C gradi
Illuminazione interna a LED

CONTROPORTA:

2 balconcini regolabili, 1 mensola con
coperchio trasparente, 1 mensola porta-oggetti
con filo metallico, 1 mensola porta-bottiglie
con filo metallico

VANO CONGELATORE:

Volume utile scomparto alimenti congelati: 26 l
1 vaschetta portagiacci

MISURE

L: 60 cm H: 154 cm P: 76,8 cm
(maniglia inclusa)

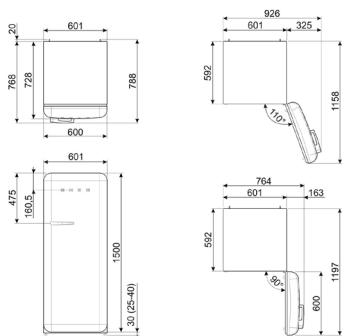

FAB28RBE5 - BLU € 1.499,00

DISPONIBILE SOLO CON CERNIERE A DX



FAB28RCR5 - PANNA € 1.499,00

CERNIERE A SX **FAB28LCR5**



FAB28RYW5 - GIALLO € 1.499,00

CERNIERE A SX **FAB28LYW5**



FAB28RSV5 - SILVER € 1.499,00

CERNIERE A SX **FAB28LSV5**



FAB28RPG5 - VERDE PASTELLO € 1.499,00

CERNIERE A SX **FAB28LPG5**



FAB28RLI5 - VERDE LIME € 1.499,00

DISPONIBILE SOLO CON CERNIERE A DX

LINEA ANNI 50

FRIGORIFERI MONOPORTA



FAB28RRD5 - ROSSO € 1.499,00

CERNIERE A SX **FAB28LRD5**



FAB28RBL5 - NERO € 1.499,00

CERNIERE A SX **FAB28LBL5**



FAB28ROR5 - ARANCIONE € 1.499,00

CERNIERE A SX **FAB28LOR5**



FAB28RPK5 - ROSA € 1.499,00

CERNIERE A SX **FAB28LPK5**



FAB28RPB5 - AZZURRO € 1.499,00

CERNIERE A SX **FAB28LPB5**



FAB28RWH5 - BIANCO € 1.499,00

CERNIERE A SX **FAB28LWH5**



LINEA ANNI 50

FRIGORIFERI MONOPORTA EDIZIONI SPECIALI

Frigorifero monoporta Estetica ANNI 50

Frigorifero monoporta 60 cm

Classe D

Frigorifero ventilato

Rumorosità: 38 dB(A)

Sbrinamento: Frigo automatico, freezer manuale

Mensole cassette e ripiani con profili cromati

VANO FRIGORIFERO:

Volume utile scomparto alimenti freschi: 223 l

Volume utile scomparto zero gradi: 21 l

1 cassetto frutta e verdura

1 ripiano regolabile in cristallo

1 Verduriera su guide scorrevoli

1 ripiano copriverdureria in cristallo

Vano Life Plus - 0°C gradi

Illuminazione interna a LED

CONTROPORTA:

2 balconcini regolabili, 1 mensola con coperchio trasparente, 1 mensola porta-oggetti con filo metallico, 1 mensola porta-bottiglie con filo metallico

VANO CONGELATORE:

Volume utile scomparto alimenti congelati: 26 l

1 vaschetta portaghiacci

MISURE

L: 60 cm H: 154 cm P: 76,8 cm

(maniglia inclusa)

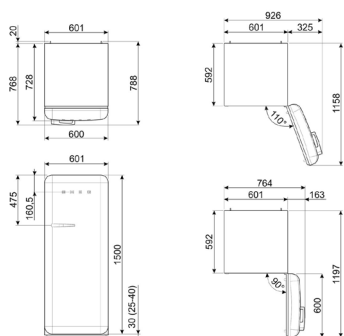

**BLACK
VELVET**

FAB28RDBLV5 € 1.899,00

DISPONIBILE SOLO CON CERNIERE A DX



**MULTI
COLOR**

FAB28RDMC5 € 1.899,00

DISPONIBILE SOLO CON CERNIERE A DX



TRICOLORE

FAB28RDIT5 € 1.899,00

DISPONIBILE SOLO CON CERNIERE A DX



**UNION
JACK**

FAB28RDUJ5 € 1.899,00

CERNIERE A SX **FAB28LDUJ5**



**BLACK
MATT**

FAB28RDBLM5 € 2.099,00

DISPONIBILE SOLO CON CERNIERE A DX



LAVAGNA

FAB28RDBB5 € 2.399,00

DISPONIBILE SOLO CON CERNIERE A DX

LINEA ANNI 50

FRIGORIFERI MONOPORTA EDIZIONI SPECIALI



**MATT
TAUPE**

FAB28RDTP5

€ 2.099,00

DISPONIBILE SOLO CON CERNIERE A DX



**RUBY
RED**

FAB28RDRB5

€ 2.099,00

DISPONIBILE SOLO CON CERNIERE A DX



**MATT
EMERALD
GREEN**

FAB28RDEG5

€ 2.099,00

DISPONIBILE SOLO CON CERNIERE A DX



LINEA ANNI 50

FRIGORIFERI MONOPORTA EDIZIONI SPECIALI

Frigorifero monoporta Estetica ANNI 50

Frigorifero monoporta 60 cm
Classe D
Frigorifero ventilato
Rumorosità: 38 dB(A)
Sbrinamento: Frigo automatico, freezer manuale
Mensole cassette e ripiani con profili cromati

VANO FRIGORIFERO:

Volume utile scomparto alimenti freschi: 223 l
Volume utile scomparto zero gradi: 21 l
1 cassetto frutta e verdura
1 ripiano regolabile in cristallo
1 Verduriera su guide scorrevoli
1 ripiano copriverdura in cristallo
Vano Life Plus - 0°C gradi
Illuminazione interna a LED

CONTROPORTA:

2 balconcini regolabili, 1 mensola con coperchio trasparente, 1 mensola porta-oggetti con filo metallico, 1 mensola porta-bottiglie con filo metallico

VANO CONGELATORE:

Volume utile scomparto alimenti congelati: 26 l
1 vaschetta portaghiacci

MISURE

L: 60 cm H: 154 cm P: 76,8 cm
(maniglia inclusa)

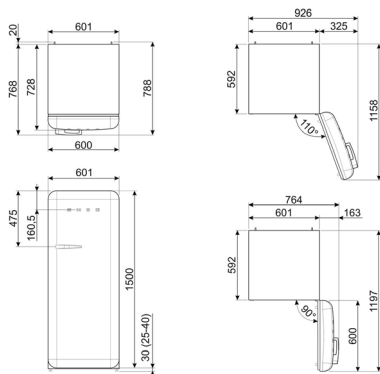

**LIGHT
BLUE**

FAB28RDLB5 € 2.099,00

DISPONIBILE SOLO CON CERNIERE A DX



**PERFECTLY
PALE**

FAB28RDPP5 € 2.099,00

DISPONIBILE SOLO CON CERNIERE A DX



RUST

FAB28RDRU5 € 2.099,00

DISPONIBILE SOLO CON CERNIERE A DX



**COCA
COLA**

FAB28RDCC5 € 2.599,00

DISPONIBILE SOLO CON CERNIERE A DX

S M E G

DRINK
Coca-Cola

Have a
Coke.

I C E C O L D



Frigorifero DUE PORTE Estetica ANNI 50

Frigorifero 2 porte 60 cm

Classe D

Frigorifero ventilato

Capacità totale lorda 298 litri

Rumorosità: 31 dB(A)

Mensole cassette e ripiani con profili cromati

Sbrinamento automatico

Tasto congelamento rapido

Allarme porta aperta: Acustico e visivo

Allarme temperatura

VANO FRIGORIFERO:

Volume utile scomparto alimenti freschi: 193 l

Volume utile scomparto zero gradi: 29 l

1 cassetto frutta e verdura

3 ripiani regolabili in cristallo

1 ripiano copriversudiera in cristallo su guide scorrevoli

1 ripiano porta-bottiglie

Vano Life Plus-0° gradi con regolazione elettronica

Illuminazione interna a LED

VANO CONGELATORE:

Volume utile scomparto alimenti congelati: 72 l

1 ripiano

MISURE

L: 60 cm H: 172 cm P: 76,8 cm

(maniglia inclusa)

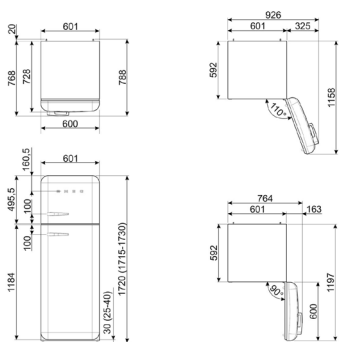

FAB30RBE5 - BLU € 1.849,00

DISPONIBILE SOLO CON CERNIERE A DX



FAB30RCR5 - PANNA € 1.849,00

CERNIERE A SX **FAB30LCR5**



FAB30RSV5 - SILVER € 1.849,00

CERNIERE A SX **FAB30LSV5**



FAB30RWH5 - BIANCO € 1.849,00

CERNIERE A SX **FAB30LWH5**



FAB30RPG5 - VERDE PASTELLO € 1.849,00

CERNIERE A SX **FAB30LPG5**



FAB30RLI5 - VERDE LIME € 1.849,00

DISPONIBILE SOLO CON CERNIERE A DX

LINEA ANNI 50

FRIGORIFERI DUE PORTE



FAB3ORRD5 - ROSSO € 1.849,00

CERNIERE A SX **FAB30LRD5**



FAB3ORBL5 - NERO € 1.849,00

CERNIERE A SX **FAB30LBL5**



FAB3OROR5 - ARANCIONE € 1.849,00

CERNIERE A SX **FAB30LOR5**



FAB3ORPK5 - ROSA € 1.849,00

CERNIERE A SX **FAB30LPK5**



FAB3ORPB5 - AZZURRO € 1.849,00

CERNIERE A SX **FAB30LPB5**



LINEA ANNI 50

FRIGORIFERI COMBINATI

Frigorifero COMBINATO Estetica ANNI 50

Frigorifero combinato 60 cm

TOTAL NO FROST

Classe D

Frigorifero ventilato

Sistema No-Frost totale

Rumorosità: 37 dB(A)

Mensole cassette e ripiani con profili cromati

Sbrinamento automatico

Tasto congelamento rapido

Allarme porta aperta: Acustico e visivo

Allarme temperatura

Due circuiti di raffreddamento

VANO FRIGORIFERO

Volume utile scomparto alimenti freschi: 204 l

Volume utile scomparto zero gradi: 30 l

1 cassetto frutta e verdura

3 ripiani regolabili in cristallo

Verduriera standard

Vano Life Plus-0° gradi con regolazione

elettronica

Illuminazione interna a LED

Multiflow

VANO CONGELATORE

Volume utile scomparto alimenti congelati: 97 l

Zona congelamento rapido

3 cassette, 2 ripiani

1 vaschetta portaghiaccio

MISURE

L: 60 cm H: 196,8 cm P: 78,8 cm

(maniglia inclusa)

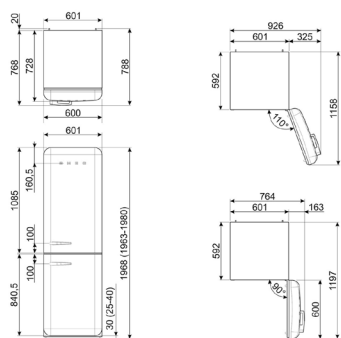

FAB32RBE5 - BLU € 2.149,00

DISPONIBILE SOLO CON CERNIERE A DX



FAB32RCR5 - PANNA € 2.149,00

CERNIERE A SX **FAB32LCR5**



FAB32RSV5 - SILVER € 2.149,00

CERNIERE A SX **FAB32LSV5**



FAB32RWH5 - BIANCO € 2.149,00

CERNIERE A SX **FAB32LWH5**



FAB32RPG5 - VERDE PASTELLO € 2.149,00

CERNIERE A SX **FAB32LPG5**



FAB32RLI5 - VERDE LIME € 2.149,00

DISPONIBILE SOLO CON CERNIERE A DX

LINEA ANNI 50

FRIGORIFERI COMBINATI



FAB32RRD5 - ROSSO € 2.149,00

CERNIERE A SX **FAB32LRD5**



FAB32RBL5 - NERO € 2.149,00

CERNIERE A SX **FAB32LBL5**



FAB32ROR5 - ARANCIONE € 2.149,00

CERNIERE A SX **FAB32LOR5**



FAB32RPK5 - ROSA € 2.149,00

CERNIERE A SX **FAB32LPK5**



FAB32RPB5 - AZZURRO € 2.149,00

CERNIERE A SX **FAB32LPB5**



LINEA ANNI 50

FRIGORIFERI COMBINATI

Frigorifero COMBINATI Estetica ANNI 50

Frigorifero combinato 70 cm

TOTAL NO FROST

Classe E

Sistema No-Frost totale

Rumorosità: 42 dB(A)

Mensole cassette e ripiani con profili cromati

Sbrinamento automatico

Tasto congelamento rapido

Allarme porta aperta: Acustico e visivo

Allarme temperatura

Due circuiti di raffreddamento

VANO FRIGORIFERO

Volume utile scomparto alimenti freschi: 309 l

Volume utile scomparto zero gradi: 24 l

1 cassetto frutta e verdura

3 ripiani regolabili in cristallo

Verduriera su guide scorrevoli

Vano Life Plus-0° gradi con regolazione elettronica

Illuminazione interna a LED

Multiflow

VANO CONGELATORE

Volume utile scomparto alimenti congelati: 128 l

Zona congelamento rapido

1 Ice maker manuale

2 cassette

2 ripiani

1 scomparto a ribaltina

MISURE

L: 70,6 cm H: 205 cm P: 81,1 cm
(maniglia inclusa)

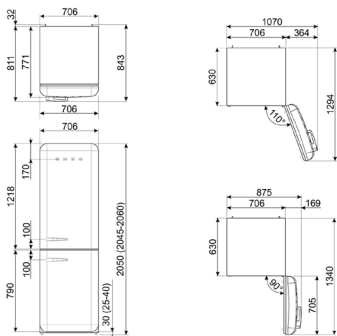

FAB38RBL5 - NERO € 2.699,00

CERNIERE A SX **FAB38LBL5**



FAB38RCR5 - PANNA € 2.699,00

CERNIERE A SX **FAB38LCR5**



FAB38RPB5 - AZZURRO € 2.699,00

DISPONIBILE SOLO CON CERNIERE A DX



FAB38RWH5 - BIANCO € 2.699,00

DISPONIBILE SOLO CON CERNIERE A DX



FAB38RPG5 - VERDE PASTELLO € 2.699,00

DISPONIBILE SOLO CON CERNIERE A DX



FAB38RRD5 - ROSSO € 2.699,00

DISPONIBILE SOLO CON CERNIERE A DX



LINEA ANNI 50

FRIGORIFERI DUE PORTE

Frigorifero DUE PORTE Estetica ANNI 50

Frigorifero 2 porte 80 cm
NO FROST
Classe E
Completamente No-Frost
Compressore Inverter

VANO FRIGORIFERO

Capacità netta 315 lt
Multiflow
Zona Life Plus 0°C
Illuminazione interna a LED
3 ripiani regolabili in cristallo
2 cassette frutta/verdura
1 ripiano copriverdura in cristallo

VANO CONGELATORE

Capacità netta 97 lt
Zona congelamento rapido
1 ripiano
1 scomparto a ribaltina
1 ice maker manuale

MISURE

L: 79,6 cm H: 187 cm P: 78 cm
(maniglia inclusa)

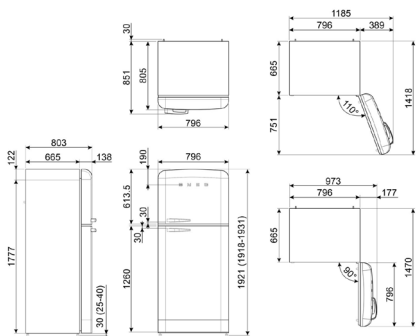

FAB50RCR5 - PANNA € 2.599,00

CERNIERE A SX **FAB50LCR5**



**FINITURE
OTTONE**

FAB50RCRB5 - PANNA € 2.599,00

DISPONIBILE SOLO CON CERNIERE A DX



FAB50RPG5 - VERDE PASTELLO € 2.599,00

DISPONIBILE SOLO CON CERNIERE A DX



FAB50RRD5 - ROSSO € 2.599,00

DISPONIBILE SOLO CON CERNIERE A DX



FAB50RBL5 - NERO € 2.599,00

CERNIERE A SX **FAB50LBL5**



FAB50RPB5 - AZZURRO € 2.599,00

DISPONIBILE SOLO CON CERNIERE A DX

LINEA ANNI 50

FRIGORIFERI DUE PORTE



FAB50RWH5 - BIANCO € 2.599,00

DISPONIBILE SOLO CON CERNIERE A DX



LINEA ANNI 50

FRIGORIFERI SOTTOTAVOLO

Frigorifero SOTTOTAVOLO Estetica ANNI 50

Frigorifero sottotavolo
Classe E
Rumorosità: 37 dB(A)
Frigorifero statico

VANO FRIGORIFERO

Volume utile scomparto alimenti freschi: 101 l
Illuminazione interna a LED
2 ripiani regolabili in cristallo
1 ripiano copriverdureria in cristallo
1 cassetto frutta e verdura

CONTROPORTA

1 mensola con coperchio trasparente
1 balconcino regolabile
1 mensola portabottiglie

CONGELATORE

Volume utile scomparto alimenti congelati: 13 l
1 vaschetta portagiaccio

MISURE

L: 54,5 cm H: 97 cm P: 70,1 cm
(maniglia inclusa)

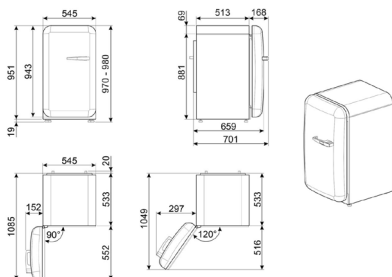

FAB10RRD5 - ROSSO € 1.049,00

CERNIERE A SX **FAB10LRD5**



FAB10RCR5 - PANNA € 1.049,00

CERNIERE A SX **FAB10LCR5**



FAB10RWH5 - BIANCO € 1.049,00

CERNIERE A SX **FAB10LWH5**



FAB10ROR5 - ARANCIONE € 1.049,00

CERNIERE A SX **FAB10LOR5**



FAB10RBL5 - NERO € 1.049,00

CERNIERE A SX **FAB10LBL5**



FAB10RPG5 - VERDE PASTELLO € 1.049,00

DISPONIBILE SOLO CON CERNIERE A DX



FAB10RPB5 - AZZURRO € 1.049,00

DISPONIBILE SOLO CON CERNIERE A DX



FAB10RPK5 - ROSA € 1.049,00

DISPONIBILE SOLO CON CERNIERE A DX

LINEA ANNI 50

FRIGORIFERI SOTTOTAVOLO

Frigorifero SOTTOTAVOLO Estetica ANNI 50

Frigorifero sottotavolo
Classe E
Rumorosità: 37 dB(A)
Frigorifero statico

VANO FRIGORIFERO

Volume utile scomparto alimenti freschi: 101 l
Illuminazione interna a LED
2 ripiani regolabili in cristallo
1 ripiano copriverdura in cristallo
1 cassetto frutta e verdura

CONTROPORTA

1 mensola con coperchio trasparente
1 balconcino regolabile
1 mensola portabottiglie

CONGELATORE

Volume utile scomparto alimenti congelati: 13 l
1 vaschetta portaghiaccio

MISURE

L: 54,5 cm H: 97 cm P: 70,1 cm
(maniglia inclusa)



FAB10RDLMS - LE MANS € 1.799,00

DISPONIBILE SOLO CON CERNIERE A DX



FAB10RDUJ5 - UNION JACK € 1.349,00

CERNIERE A SX **FAB10RDUJ5**



FAB10RDSN5 - SNOOPY € 2.399,00

DISPONIBILE SOLO CON CERNIERE A DX



LINEA ANNI 50

FRIGORIFERI HAPPY BAR

Frigorifero HAPPY BAR Estetica ANNI 50

Frigorifero Happy Bar
Classe E
Rumorosità: 37 dB(A)
Frigorifero statico

FRIGORIFERO

Capacità netta 130 lt
Illuminazione interna a LED
2 ripiani regolabili in cristallo
1 ripiano portabottiglie

CONTROPORTA

1 mensole con coperchio trasparente
1 balconcino regolabile
1 mensola portabottiglie

MISURE

L: 54,5 cm H: 97 cm P: 70,1 cm
(maniglia inclusa)

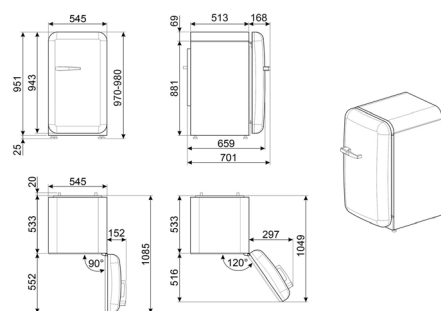

FAB10HRBL5 - NERO € 1.099,00

CERNIERE A SX **FAB10HLBL5**



FAB10HRRD5 - ROSSO € 1.099,00

CERNIERE A SX **FAB10HLRD5**



FAB10HRPB5 - AZZURRO € 1.099,00

DISPONIBILE SOLO CON CERNIERE A DX



FAB10HRCR5 - PANNA € 1.099,00

CERNIERE A SX **FAB10HLCR5**



FAB10HRPK5 - ROSA € 1.099,00

DISPONIBILE SOLO CON CERNIERE A DX



FAB10HRPG5 - VERDE PASTELLO € 1.099,00

DISPONIBILE SOLO CON CERNIERE A DX



FAB10HRWH5 - BIANCO € 1.099,00

CERNIERE A SX **FAB10HLWH5**



FAB10HRDIT5 - ITALIA € 1.499,00

DISPONIBILE SOLO CON CERNIERE A DX

LINEA ANNI 50

MINIBAR

Frigorifero MINIBAR Estetica ANNI 50

Frigorifero Minibar
Classe D
Rumorosità: 40 dB(A)
Apparecchio a temperatura moderata

FRIGORIFERO

Capacità netta 34 lt - 2 ripiani regolabili
Illuminazione interna
L: 40,4 cm H: 74 cm P: 57 cm (maniglia inclusa)



FAB5RCR5 - PANNA € 949,00

CERNIERE A SX **FAB5LCR5**



FAB5RSV5 - SILVER € 949,00

CERNIERE A SX **FAB5LSV5**



FAB5RPG5 - VERDE PASTELLO € 949,00

CERNIERE A SX **FAB5LPG5**



FAB5RRD5 - ROSSO € 949,00

CERNIERE A SX **FAB5LRD5**



FAB5RBL5 - NERO € 949,00

CERNIERE A SX **FAB5LBL5**



FAB5ROR5 - ARANCIONE € 949,00

CERNIERE A SX **FAB5LOR5**



FAB5RPK5 - ROSA € 949,00

CERNIERE A SX **FAB5LPK5**



FAB5RPB5 - AZZURRO € 949,00

CERNIERE A SX **FAB5LPB5**



FAB5RWH5 - BIANCO € 949,00

CERNIERE A SX **FAB5LWH5**



FAB5RDGO5 - ORO € 1.849,00

DISPONIBILE SOLO CON CERNIERE A DX



FAB5RDUJ5 - UNION JACK € 1.199,00

CERNIERE A SX **FAB5LDUJ5**

LINEA ANNI 50

LAVASTOVIGLIE

Lavastoviglie LIBERO POSIZIONAMENTO Estetica ANNI 50

3 CESTI
Classe B
13 coperti - 45 dB - 10+1 programmi
Programmi: Ammolto, Express 27', Full express 60', ECO, Auto 45-65, Silent(-2dB), Mix, Intensive, Hygiene 99,9%, Self clean, Calici
Terzo cesto FlexiDuo - EasyGlide
Motore Inverter 2.0
Opzione Partenza differita fino a 9 ore
1/2 carico FlexiZone, Dry Assist+
Pannello comandi inox antimpronta con display LED per programmazione differita
Cestello superiore con 3 inserti abbattibili
Sistema lavaggio Planetarium
Quantità consumo acqua 9.0 lt
Acquastop totale



LVFABBL3 - NERO € 1.749,00

LIBERO POSIZIONAMENTO



LVFABBL3 - CREMA € 1.749,00

LIBERO POSIZIONAMENTO

Lavastoviglie SOTTOPIANO Estetica ANNI 50

Classe B
13 coperti - 44 dB - 10+1 programmi
Programmi: Ammolto, Express 27', Full express 60', ECO, Auto 45-65, Silent(-2dB), Mix, Intensive, Hygiene 99,9%, Self clean, Calici
Terzo cesto FlexiDuo - EasyGlide
Motore Inverter 2.0
Opzione Partenza differita fino a 9 ore
1/2 carico FlexiZone, Dry Assist+
Pannello comandi inox antimpronta con display LED per programmazione differita
Cestello superiore con 3 inserti abbattibili
Sistema lavaggio Planetarium
Quantità consumo acqua 9.0 lt
Acquastop totale



STFABWH3 - BIANCO € 1.499,00

SOTTOPIANO



STFABCR3 - PANNA € 1.499,00

SOTTOPIANO

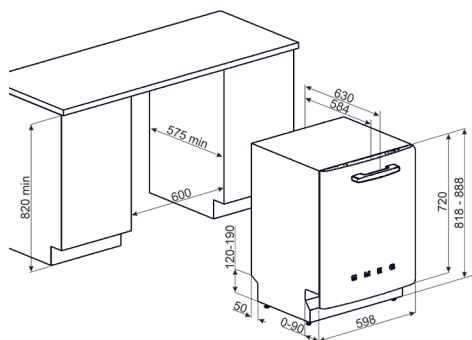

STFABBL3 - NERO € 1.499,00

SOTTOPIANO



STFABRD3 - ROSSO € 1.499,00

SOTTOPIANO



S M E G

S M E G

CON LA PROMO SMEG DESIGN 2023 PUOI ACQUISTARE,
CON UN SOLO EURO, UN ARTICOLO PED SMEG

PICCOLI ELETTRODOMESTICI

EDIZIONI SPECIALI - BLU MEDITERRANEO DOLCE & GABBANA



ECF02DGBEU - MACCHINA CAFFÈ ESPRESSO

€ 1.399,00

PROMO SMEG DESIGN
LISTINO 24.499,00 €



MFF01DGBEU - MONTALATTE

€ 599,00

PROMO SMEG DESIGN
LISTINO 10.599,00 €



CGF01DGBEU - MACINACAFFÈ

€ 799,00

PROMO SMEG DESIGN
LISTINO 13.999,00 €



KLF03DGBEU - BOLLITORE STANDARD

€ 599,00

PROMO SMEG DESIGN
LISTINO 10.599,00 €



TSF01DGBEU - TOSTAPANE 2X2

€ 599,00

PROMO SMEG DESIGN
LISTINO 10.599,00 €



CJF01DGBEU - SPREMIAGRUMI

€ 599,00

PROMO SMEG DESIGN
LISTINO 10.599,00 €



CON LA PROMO SMEG DESIGN 2023 PUOI ACQUISTARE,
CON UN SOLO EURO, UN ARTICOLO PED SMEG

PICCOLI ELETTRODOMESTICI

EDIZIONI SPECIALI - SICILY IS MY LOVE DOLCE & GABBANA



TSF01DGEU - TOSTAPANE 2X2

€ 599,00

PROMO SMEG DESIGN
LISTINO 10.599,00 €



SMF03DGEU - IMPASTATRICE

€ 1.399,00

PROMO SMEG DESIGN
LISTINO 24.499,00 €



BLF01DGEU - FRULLATORE DA TAVOLO

€ 869,00

PROMO SMEG DESIGN
LISTINO 14.999,00 €



CJF01DGEU - SPREMIAGRUMI

€ 599,00

PROMO SMEG DESIGN
LISTINO 10.599,00 €



KLF03DGEU - BOLLITORE STANDARD

€ 599,00

PROMO SMEG DESIGN
LISTINO 10.599,00 €



CON LA PROMO SMEG DESIGN 2023 PUOI ACQUISTARE,
CON UN SOLO EURO, UN ARTICOLO PED SMEG

PICCOLI ELETTRODOMESTICI

EDIZIONI SPECIALI TOSTAPANE



TSF01EGMEU | VERDE SMERALDO
TOSTAPANE 2X2

€ 199,00



TSF01CUJEU | UNION JACK
TOSTAPANE 2X2

€ 199,00



TSF01GOEU | ORO
TOSTAPANE 2X2

€ 199,00



TSF01RGEU | ORO ROSA
TOSTAPANE 2X2

€ 199,00



TSF01SSEU | ACCIAIO INOX
TOSTAPANE 2X2

€ 199,00



TSF01WHMEU | BIANCO OPACO
TOSTAPANE 2X2

€ 199,00



TSF01BLMEU | NERO OPACO
TOSTAPANE 2X2

€ 199,00



TSF01CHMEU | ORO OPACO
TOSTAPANE 2X2

€ 199,00

EDIZIONI SPECIALI - BOLLITORE



KLF03SSEU | ACCIAIO INOX
BOLLITORE STANDARD

€ 199,00



KLF03GOEU | ORO
BOLLITORE STANDARD

€ 199,00



KLF03RGEU | ORO ROSA
BOLLITORE STANDARD

€ 199,00



KLF03BLMEU | NERO OPACO
BOLLITORE STANDARD

€ 199,00



KLF03WHMEU | BIANCO OPACO
BOLLITORE STANDARD

€ 199,00



KLF03CHMEU | ORO OPACO
BOLLITORE STANDARD

€ 199,00



KLF03EGMEU | VERDE SMERALDO
BOLLITORE STANDARD

€ 199,00

PROMO SMEG DESIGN
LISTINO 3.499,00 €

CON LA PROMO SMEG DESIGN 2023 PUOI ACQUISTARE,
CON UN SOLO EURO, UN ARTICOLO PED SMEG

PICCOLI ELETTRODOMESTICI

EDIZIONI SPECIALI - BOLLITORE E TOSTAPANE ACCIAIO INOX



KLF04SSEU | ACCIAIO INOX
BOLLITORE TEMPERATURA VARIABILE

€ 219,00



TSF02SSEU | ACCIAIO INOX
TOSTAPANE 2X4

€ 219,00



TSF03SSEU | ACCIAIO INOX
TOSTAPANE 4X4

€ 239,00

PROMO SMEG DESIGN
LISTINO 3.899,00 €

PROMO SMEG DESIGN
LISTINO 4.239,00 €



CON LA PROMO SMEG DESIGN 2023 PUOI ACQUISTARE,
CON UN SOLO EURO, UN ARTICOLO PED SMEG

PICCOLI ELETTRODOMESTICI

EDIZIONI SPECIALI KIT IMPASTATRICI



IMPASTATRICE FULL COLOR
EDIZIONE SPECIALE
ICE CREAM

SMF33CRIT - CREMA

€ 629,00

PROMO SMEG DESIGN
LISTINO 11.169,00 €

IMPASTATRICE FULL COLOR
EDIZIONE SPECIALE
GOURMET

SMF43RDIT - ROSSO

€ 629,00

PROMO SMEG DESIGN
LISTINO 11.169,00 €



IMPASTATRICE FULL COLOR
EDIZIONE SPECIALE
BBQ

SMF23BLIT - NERO

€ 609,00

PROMO SMEG DESIGN
LISTINO 10.799,00 €



IMPASTATRICE FULL COLOR
EDIZIONE SPECIALE
CON CIOTOLA TRASPARENTE

SMF13WHEU - BIANCO

€ 599,00

PROMO SMEG DESIGN
LISTINO 10.639,00 €



CON LA PROMO SMEG DESIGN 2023 PUOI ACQUISTARE, CON UN SOLO EURO, UN ARTICOLO PED SMEG

PICCOLI ELETTRODOMESTICI

EDIZIONI SPECIALI - VARIE

Per Caratteristiche Vedi Pagina 48



BCC02FBMEU - FULL BLACK
MACCHINA DA CAFFÈ AUTOMATICA

€ 769,00

PROMO SMEG DESIGN
LISTINO 13.649,00 €

Per Caratteristiche Vedi Pagina 51



DCF02SSEU - ACCIAIO INOX
MACCHINA DA CAFFÈ FILTRO

€ 229,00

PROMO SMEG DESIGN
LISTINO 6.999,00 €

Per Caratteristiche Vedi Pagina 61



BLC02EGMEU - VERDE SMERALDO
FRULLATORE DA TAVOLO ALTE PRESTAZIONI
CON POMPA SOTTOVUOTO

€ 479,00

PROMO SMEG DESIGN
LISTINO 8.499,00 €

Per Caratteristiche Vedi Pagina 72



CJF01WHMEU - BIANCO OPACO
SPREMIAGRUMI

€ 199,00

Per Caratteristiche Vedi Pagina 72



CJF01BMEU - NERO OPACO
SPREMIAGRUMI

€ 199,00

PROMO SMEG DESIGN
LISTINO 3.499,00 €



PICCOLI ELETTRODOMESTICI

MACCHINA DA CAFFÈ CON MACINA CAFFÈ INTEGRATO

TIPOLOGIA DI CAFFÈ UTILIZZATO:

- Caffè in grani
- Caffè in polvere

CARATTERISTICHE TECNICHE:

- Corpo in alluminio pressofuso
- Scaldavvance in acciaio inox
- Leva vapore
- Sistema di riscaldamento Doppio Thermoblock
- Pressione 15 bar (per circuito vapore)
- Pressione 20 bar (per circuito caffè)
- Portafiltro acciaio inox
- Pannello di controllo intuitivo
- Vaschetta raccogliacqua, rimovibile per alloggiamento tazze grandi
- Serbatoio d'acqua da 2,4 L, rimovibile
- Inclusi: 4 filtri in acciaio inox (1 tazza parete singola o doppia e 2 tazze parete singola o doppia)

FUNZIONI:

- Pulsante 1-tazza
- Pulsante 2-tazze
- Funzione vapore
- Funzione stop per regolare la lunghezza del caffè
- Impostazioni temperatura di estrazione caffè
- Impostazione profili di preinfusione
- Striscia per teste durezza dell'acqua
- Avviso decalcificazione
- Stand-by regolabile



EGF03CREU - CREMA

€ 869,00



EGF03PBEU - AZZURRO

€ 869,00



EGF03PGEU - VERDE PASTELLO

€ 869,00



EGF03RDEU - ROSSO

€ 869,00

**PROMO SMEG DESIGN
LISTINO 15.299,00 €**



EGF03WHEU - BIANCO

€ 869,00



EGF03BLEU - NERO

€ 869,00

CON LA PROMO SMEG DESIGN 2023 PUOI ACQUISTARE,
CON UN SOLO EURO, UN ARTICOLO PED SMEG



CON LA PROMO SMEG DESIGN 2023 PUOI ACQUISTARE,
CON UN SOLO EURO, UN ARTICOLO PED SMEG

PICCOLI ELETTRODOMESTICI

MACCHINA DA CAFFÈ AUTOMATICA CON LANCIA

TIPOLOGIA DI CAFFÈ UTILIZZATO:

- Caffè in grani

CARATTERISTICHE TECNICHE:

- Materiale corpo plastica
- Finitura opaca
- Pannello frontale e vassoio in alluminio spazzolato
- Base cromata
- Sistema di riscaldamento Thermoblock
- Pressione 19 bar
- Gruppo infusore rimovibile
- Capacità contenitore chicchi 150 gr
- Capacità contenitore fondi caffè: 8
- Tanica acqua removibile
- Capacità serbatoio acqua 1,4 l
- Cassetto raccogliocce
- Lancia erogazione vapore

FUNZIONI:

- Caffè Ristretto, Caffè Espresso, Caffè,
- Acqua Calda
- Caffè Ristretto Light, Caffè Espresso Light,
- Caffè Lungo, Vapore
- Livello di macinatura regolabile
- Lunghezza del caffè regolabile
- Erogatore caffè regolabile in altezza
- Impostazione dell'acqua programmabile (leggera/media/dura)
- Spegnimento automatico (dopo 20 min di inattività)



BCC02TPMEU - TAUPE

€ 719,00



BCC02BLMEU - NERO

€ 719,00



BCC02WHMEU - BIANCO

€ 719,00



BCC02RDMEU - ROSSO

€ 719,00



BCC02EGMEU - VERDE SMERALDO

€ 719,00

**PROMO SMEG DESIGN
LISTINO 12.599,00 €**



PICCOLI ELETTRODOMESTICI

MACCHINA DA CAFFÈ AUTOMATICA

TIPOLOGIA DI CAFFÈ UTILIZZATO:

- Caffè in grani

CARATTERISTICHE TECNICHE:

- Materiale corpo plastica
- Finitura opaca
- Pannello frontale e vassoio in alluminio spazzolato
- Base cromata
- Sistema di riscaldamento Thermoblock
- Pressione 19 bar
- Gruppo infusore rimovibile
- Capacità contenitore chicchi 150 gr
- Capacità contenitore fondi caffè: 8
- Tanica acqua removibile
- Capacità serbatoio acqua 1,4 l
- Cassetto raccogliocce

FUNZIONI:

- Caffè Ristretto, Caffè Espresso, Caffè,
- Acqua Calda
- Caffè Ristretto Light, Caffè Espresso Light,
- Caffè Lungo, Americano
- Livello di macinatura regolabile
- Lunghezza del caffè regolabile
- Erogatore caffè regolabile in altezza
- Impostazione dell'acqua programmabile (leggera/media/dura)
- Spegnimento automatico (dopo 20 min di inattività)



BCC01TPMEU - TAUPE

€ 629,00



BCC01BLMEU - NERO

€ 629,00



BCC01WHMEU - BIANCO

€ 629,00



BCC01RDMEU - ROSSO

€ 629,00

**PROMO SMEG DESIGN
LISTINO 10.999,00 €**



BCC01EGMEU - VERDE SMERALDO

€ 629,00



PICCOLI ELETTRODOMESTICI

MACCHINA DA CAFFÈ ESPRESSO MANUALE

TIPOLOGIA DI CAFFÈ UTILIZZATO:

- Caffè in grani
- Caffè in polvere

CARATTERISTICHE TECNICHE:

- Corpo in alluminio pressofuso
- Scaldavvane in acciaio inox
- Leva vapore
- Sistema di riscaldamento Doppio Thermoblock
- Pressione 15 bar (per circuito vapore)
- Pressione 20 bar (per circuito caffè)
- Portafiltro acciaio inox
- Pannello di controllo intuitivo
- Vaschetta raccogliocce, rimovibile per alloggiamento tazze grandi
- Serbatoio d'acqua da 2,4 L, rimovibile
- Inclusi: 4 filtri in acciaio inox (1 tazza parete singola o doppia e 2 tazze parete singola o doppia)

FUNZIONI:

- Pulsante 1 tazza
- Pulsante 2-tazze
- Funzione vapore
- Funzione stop per regolare la lunghezza del caffè
- Impostazioni temperatura di estrazione caffè
- Impostazione profili di preinfusione
- Striscia per teste durezza dell'acqua
- Avviso decalcificazione
- Stand-by regolabile



ECF02CREU - CREMA

€ 399,00



ECF02PBEU - AZZURRO

€ 399,00



ECF02PGEU - VERDE PASTELLO

€ 399,00



ECF02RDEU - ROSSO

€ 399,00



ECF02WHEU - BIANCO

€ 399,00



ECF02BLEU - NERO

€ 399,00

**PROMO SMEG DESIGN
LISTINO 6.999,00 €**



PICCOLI ELETTRODOMESTICI

MACCHINA DA CAFFÈ FILTRO



DCF02GREU - GRAFITE

€ 199,00



DCF02CREU - CREMA

€ 199,00



DCF02PBEU - AZZURRO

€ 199,00

TIPOLOGIA DI CAFFÈ UTILIZZATO:

- Caffè in polvere

CARATTERISTICHE TECNICHE:

- Corpo in acciaio verniciato
- Capacità 10 tazze
- Display LED Digitale e Orologio
- Pannello di controllo intuitivo
- Filtro permanente con maniglia, semplice da utilizzare e pulire
- Caraffa in vetro capacità 10 tazze, con coperchio e maniglia
- Serbatoio acqua 1.4 L
- Indicatore livello acqua
- Piedini antiscivolo
- Potenza: 1050 W

FUNZIONI:

- Pulsante ON/OFF
- Funzione 1-4 tazze
- Tasto selezione Aroma: Delicato o Intenso
- Funzione stop per regolare la lunghezza del caffè
- Funzione Auto Start: impostazione orario automatico di accensione
- Leva impostazione Orologio/Timer
- Funzione Keep Warm: 1 ora
- Regolazione durezza dell'acqua
- Sistema antigoccia
- Spia luminosa di avviso decalcificazione

FUNZIONI:

- Misurino caffè macinato: capienza indicativa polvere per 2 tazze



DCF02PGEU - VERDE PASTELLO

€ 199,00



DCF02RDEU - ROSSO

€ 199,00



DCF02WHEU - BIANCO

€ 199,00



DCF02BLEU - NERO

€ 199,00

**PROMO SMEG DESIGN
LISTINO 3.499,00 €**



CON LA PROMO SMEG DESIGN 2023 PUOI ACQUISTARE,
CON UN SOLO EURO, UN ARTICOLO PED SMEG

PICCOLI ELETTRODOMESTICI

MACINACAFFÈ



CGF11CREU - CREMA

€ 269,00



CGF11PGEU - VERDE PASTELLO

€ 269,00



CGF11RDEU - ROSSO

€ 269,00

CARATTERISTICHE TECNICHE:

- Corpo in alluminio pressofuso
- Contenitore chicchi e contenitore caffè macinato: Tritan™
- Materiale macine coniche: Acciaio Inox
- Sistema di riscaldamento Doppio Thermoblock
- Base cromata lucida
- Capacità Contenitore chicchi caffè: 350 gr
- Capacità Contenitore caffè macinato: 130 gr
- Macina superiore e piattino removibili
- Avvolgicavo integrato

FUNZIONI:

- Possibilità di personalizzare la quantità di caffè
- Contenitore chicchi con Twist & Lock system
- Livelli di macinatura del caffè regolabile (30 livelli)
- Funzione stop per regolare la lunghezza del caffè
- 2 Funzioni per caffè espresso
- 6 Funzioni per caffè Americano/ French Press
- Funzione manuale



CGF11WHEU - BIANCO

€ 269,00



CGF11BLEU - NERO

€ 269,00

**PROMO SMEG DESIGN
LISTINO 4.699,00 €**



CON LA PROMO SMEG DESIGN 2023 PUOI ACQUISTARE,
CON UN SOLO EURO, UN ARTICOLO PED SMEG

PICCOLI ELETTRODOMESTICI

MONTALATTE A INDUZIONE



MFF11PKEU - ROSA

€ 199,00



MFF11CREU - CREMA

€ 199,00



MFF11PBEU - AZZURRO

€ 199,00

CARATTERISTICHE TECNICHE:

- Corpo in acciaio inox/plastica
- Materiale tappo misuratore e coperchio: Tritan™ Renew
- Materiale caraffa: Acciaio inox
- Sistema ad induzione con spegnimento automatico
- Capacità caraffa per Montatura latte: 250 ml/1 cup
- Capacità caraffa per riscaldamento latte e cioccolata: 600 ml/2.5 cup
- Caraffa e tappo misuratore rimovibili
- Avvolgicavo integrato

FUNZIONI E PROGRAMMI

- Funzione Cioccolata calda
- Funzione Latte Caldo con schiuma leggera
- Funzione Latte Freddo con schiuma leggera:
- Funzione Manuale Caldo
- Funzione Latte Caldo
- Funzione Latte Caldo con schiuma densa
- Funzione Latte Freddo con schiuma densa
- Funzione Manuale Freddo



MFF11PGEU - VERDE PASTELLO

€ 199,00



MFF11RDEU - ROSSO

€ 199,00



MFF11WHEU - BIANCO

€ 199,00



MFF11BLEU - NERO

€ 199,00

PROMO SMEG DESIGN
LISTINO 3.499,00 €

PICCOLI ELETTRODOMESTICI

IMPASTATRICI FULL COLOR

CARATTERISTICHE TECNICHE:

- Corpo e base in alluminio pressofuso
- Materiale ciotola acciaio inox
- Pomello leva selezione velocità acciaio inox
- Movimento planetario
- Motore a presa diretta
- Sicurezza blocco motore con testa sollevata
- Protezione sovraccarico motore
- Attacco frontale per applicazione accessori opzionali
- Ciotola in acciaio inox lucido con maniglia ergonomica da 4,8 Lt
- Piedini antiscivolo
- Potenza 800 W

FUNZIONI

- 10 livelli di velocità con funzione Smooth Start

CAPACITÀ

- Q.tà max albumi 12/ min 2
- Impasto per torta max 2,0 Kg
- Impasto per dolci max 2,6 Kg
- Impasto per pasta all'uovo 500g impasto totale con 3 uova
- Impasto per pane/pizza 1,8 Kg impasto totale (max 1,2 Kg di farina)
- Panna montata min 100 ml e max 1L

ACCESSORI INCLUSI

- Gancio impastatore alluminio (SMDH01)
- Frusta piatta alluminio (SMFB01)
- Frusta a filo acciaio inox (SMVW02)
- Ciotola 4,8 Lt in acciaio inox (SMB401)
- Coperchio versatore antispruzzo in plastica (SMPS01)
- Ricettario impastatrice



SMF03CREU - CREMA

€ 579,00



SMF03PBEU - AZZURRO

€ 579,00



SMF03PGEU - VERDE PASTELLO

€ 579,00



SMF03PKEU - ROSA

€ 579,00



SMF03RDEU - ROSSO

€ 579,00



SMF03BLEU - NERO

€ 579,00



SMF03GREU - GRAFITE

€ 579,00



SMF03WHEU - BIANCO

€ 579,00

**PROMO SMEG DESIGN
LISTINO 9.999,00 €**

CON LA PROMO SMEG DESIGN 2023 PUOI ACQUISTARE,
CON UN SOLO EURO, UN ARTICOLO PED SMEG



PICCOLI ELETTRODOMESTICI

IMPASTATRICI STANDARD

CARATTERISTICHE TECNICHE:

- Corpo in alluminio pressofuso
- Base in lega di zinco con attacco ciotola acciaio inox
- Pomello leva selezione velocità acciaio inox

FUNZIONI

- 10 livelli di velocità con funzione Smooth Start

CAPACITÀ

- Q.tà max albumi 12/ min 2
- Impasto per torta max 2,0 Kg
- Impasto per dolci max 2,6 Kg
- Impasto per pasta all'uovo 500g impasto totale con 3 uova
- Impasto per pane/pizza 1,8 Kg impasto totale (max 1,2 Kg di farina)
- Panna montata min 100 ml e max 1L

ACCESSORI INCLUSI

- Gancio impastatore alluminio (SMDH01)
- Frusta piatta alluminio (SMFB01)
- Frusta a filo acciaio inox (SMVVV02)
- Ciotola 4,8 lt in acciaio inox (SMB401)
- Coperchio versatore antispruzzo in plastica (SMPS01)
- Ricettario impastatrice



SMF02CREU - CREMA

€ 499,00



SMF02PBEU - AZZURRO

€ 499,00



SMF02PGEU - VERDE PASTELLO

€ 499,00



SMF02PKEU - ROSA

€ 499,00



SMF02RDEU - ROSSO

€ 499,00



SMF03BLEU - NERO

€ 499,00



SMF02SVEU - SILVER

€ 499,00

**PROMO SMEG DESIGN
LISTINO 8.799,00 €**

CON LA PROMO SMEG DESIGN 2023 PUOI ACQUISTARE,
CON UN SOLO EURO, UN ARTICOLO PED SMEG



PICCOLI ELETTRODOMESTICI

SBATTITORE ELETTRICO

CARATTERISTICHE TECNICHE:

- Corpo in plastica ABS
- Impugnatura in plastica soft touch
- Leva cromata lucida
- Funzione turbo
- Controllo velocità elettronico
- Potenza 250 W

FUNZIONI

- Sistema avvio graduale
- 9 livelli di velocità
- Avanzamento timer in minuti

ACCESSORI INCLUSI

- 2 fruste a filo acciaio inox
- 2 fruste optimus acciaio inox
- 2 ganci impastatore acciaio inox
- Lavabili in lavastoviglie



HMF01CREU - CREMA

€ 159,00



HMF01PBEU - AZZURRO

€ 159,00



HMF01PGEU - VERDE PASTELLO

€ 159,00



HMF01PKEU - ROSA

€ 159,00



HMF01RDEU - ROSSO

€ 159,00



HMF01BLEU - NERO

€ 159,00



HMF01WHEU - BIANCO

€ 159,00

**PROMO SMEG DESIGN
LISTINO 2.799,00 €**

CON LA PROMO SMEG DESIGN 2023 PUOI ACQUISTARE,
CON UN SOLO EURO, UN ARTICOLO PED SMEG

PICCOLI ELETTRODOMESTICI

FRULLATORE DA TAVOLO

CARATTERISTICHE TECNICHE:

- Corpo in alluminio pressofuso
- Manopola comandi plastica cromata
- Caraffa da 1,5 Lt(6 tazze) in Tritan™ Renew
- Tappo dosatore
- Sicurezza blocco motore
- Protezione termica motore
- Motore con funzione Smooth Start
- Vano avvolgicavo integrato
- Base antiscivolo opaca soft-touch
- Potenza 800 W (max 18000 giri/min)

FUNZIONI

- 4 livelli di velocità
- 4 programmi preimpostati: Smoothie, Green Smoothie, Tritagliaccio, Auto-pulizia



BLF03CREU - CREMA

€ 249,00



BLF03PBEU - AZZURRO

€ 249,00



BLF03PGEU - VERDE PASTELLO

€ 249,00



BLF03WHEU - BIANCO

€ 249,00

PROMO SMEG DESIGN
LISTINO 4.399,00 €



BLF03RDEU - ROSSO

€ 249,00



SBLF03BLEU - NERO

€ 249,00

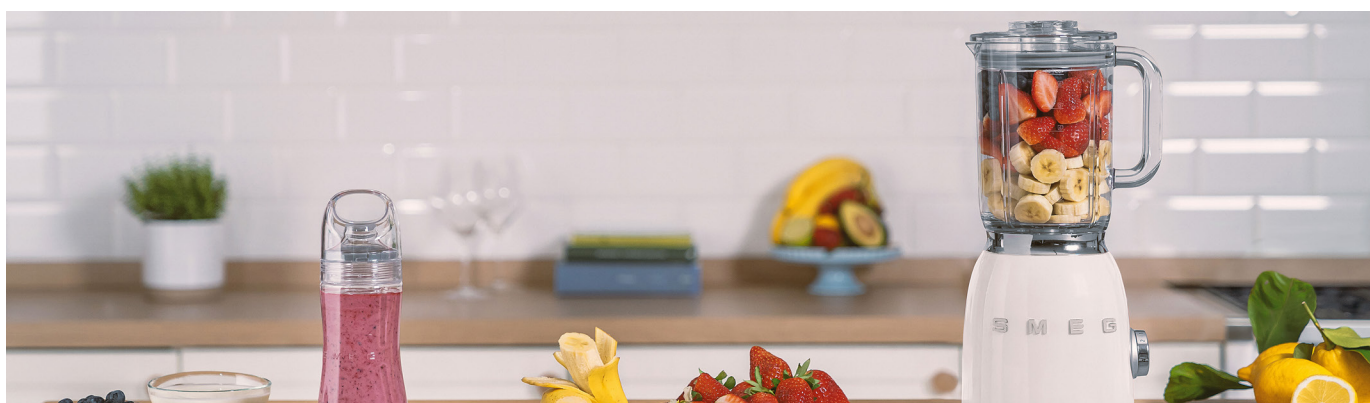

CON LA PROMO SMEG DESIGN 2023 PUOI ACQUISTARE,
CON UN SOLO EURO, UN ARTICOLO PED SMEG

PICCOLI ELETTRODOMESTICI

FRULLATORE A IMMERSIONE CON ACCESSORI

CARATTERISTICHE TECNICHE:

- Corpo motore in plastica verniciata
- Ergonomica impugnatura anti-scivolo
- Asta in acciaio inox
- Lame in acciaio inox con sistema FLOWBLENDTM
- Selettore della velocità variabile
- Pulsante ON/OFF
- Pulsante Turbo
- Potenza motore: 700 W

QUATTRO ACCESSORI INCLUSI

- Bicchieri in Tritan Renew
- Tritatutto
- Schiaccia verdure
- Frusta a filo



HBF22CREU - CREMA

€ 159,00



HBF22PBEU - AZZURRO

€ 159,00



HBF22RDEU - ROSSO

€ 159,00



HBF22BLEU - NERO

€ 159,00

**PROMO SMEG DESIGN
LISTINO 2.799,00 €**



PICCOLI ELETTRODOMESTICI

FRULLATORE A IMMERSIONE

CARATTERISTICHE TECNICHE:

- Corpo motore in plastica verniciata
- Ergonomica impugnatura anti-scivolo
- Asta in acciaio inox
- Lame in acciaio inox con sistema FLOWBLEND™
- Selettore della velocità variabile,
- Pulsante ON/OFF,
- Pulsante Turbo
- Potenza motore: 700 W



HBF11CREU - CREMA

€ 99,00



HBF11PBEU - AZZURRO

€ 99,00



HBF11RDEU - ROSSO

€ 99,00



HBF11BLEU - NERO

€ 99,00

PROMO SMEG DESIGN
LISTINO 1.739,00 €

PICCOLI ELETTRODOMESTICI

FRULLATORE DA TAVOLO AD ALTE PRESTAZIONI

CARATTERISTICHE TECNICHE:

- Corpo in plastica
- Pulsanti/Manopola con ghiera in alluminio
- Caraffa da 1,5 Lt (6 tazze) in Tritan™ Renew
- Tappo dosatore
- Sicurezza blocco motore
- Protezione termica motore
- Motore con funzione Smooth Start
- Base antiscivolo opaca soft-touch
- Potenza 1400 W (max 22000 giri/min)

FUNZIONI

- 9 livelli di velocità
- 5 programmi preimpostati:
- Smoothie, Green Smoothie, Frozen Dessert
- Tritaghiaccio, Auto-pulizia



BLC01WHMEU - BIANCO OPACO

€ 399,00



BLC01BLMEU - NERO OPACO

€ 399,00

PROMO SMEG DESIGN
LISTINO 4.399,00 €

PICCOLI ELETTRODOMESTICI

FRULLATORE COMPATTO MULTIFUNZIONE

CARATTERISTICHE TECNICHE:

- Corpo in alluminio pressofuso
- Manopola comandi plastica
- 2 Bottiglie da 0,6 Lt in Tritan™ Renew senza BPA
- Doppia lama in acciaio inox non rimovibile
- Sicurezza blocco motore con bottiglia sollevata
- dalla base
- Protezione sovraccarico motore
- Vano avvolgicavo integrato
- Base antiscivolo
- Potenza 300 W (max 24000 giri/min)

FUNZIONI

- 2 livelli di velocità



PBF01CREU - CREMA

€ 129,00



PBF01PBEU - AZZURRO

€ 129,00



PBF01PGEU - VERDE PASTELLO

€ 129,00



PBF01PKEU - ROSA

€ 129,00

**PROMO SMEG DESIGN
LISTINO 2.289,00 €**



PBF01RDEU - ROSSO

€ 129,00



PBF01BLEU - NERO

€ 129,00



PBF01WHEU - BIANCO

€ 129,00

CON LA PROMO SMEG DESIGN 2023 PUOI ACQUISTARE,
CON UN SOLO EURO, UN ARTICOLO PED SMEG



PICCOLI ELETTRODOMESTICI

TOSTAPANE 4X4

CARATTERISTICHE TECNICHE:

- Corpo in acciaio verniciato
- Leve attivazione ciclo in acciaio inox
- Manopole comandi cromate retroilluminate
- 2 pannelli comandi indipendenti
- Nr. 2 coppie di ampi scomparti (36mm ciascuno)
- Centratrice automatica delle fette
- Espulsione automatica a fine ciclo
- 2 cassetti raccoglibriciole in acciaio inox estraibili
- Vano avvolgicavo integrato
- Piedini antiscivolo
- Potenza 2000 W

FUNZIONI

- 6 livelli di doratura
- 3 programmi preimpostati:
• Riscaldamento, Scongelo, Bagel

ACCESSORI ESCLUSI

- TSSR01 - 2 pinze sandwich
- TSBW01 - scaldapanini



TSF03CREU - CREMA

€ 219,00



TSF03PBEU - AZZURRO

€ 219,00



TSF03PGEU - VERDE PASTELLO

€ 219,00



TSF03PKEU - ROSA

€ 219,00

**PROMO SMEG DESIGN
LISTINO 3.899,00 €**



TSF03RDEU - ROSSO

€ 219,00



TSF03BLEU - NERO

€ 219,00



TSF03WHEU - BIANCO

€ 219,00

PICCOLI ELETTRODOMESTICI

TOSTAPANE 2X4

CARATTERISTICHE TECNICHE:

- Corpo in acciaio verniciato
- Base cromata lucida
- Pomello leva attivazione ciclo in acciaio inox
- Manopola comandi cromata retroilluminata
- Nr. 2 ampi scomparti (36mm ciascuno)
- Centratrice automatica delle fette
- Espulsione automatica a fine ciclo
- Cassetto raccoglibriciole in acciaio inox estraibile
- Vano avvolgicavo integrato
- Piedini antiscivolo
- Potenza 1500 W

FUNZIONI

- 6 livelli di doratura
- 3 programmi preimpostati:
• Riscaldamento, Scongelo, Bagel

ACCESSORI ESCLUSI

- TSSR02 - 2 pinze sandwich
- TSBW02 - scaldapanini



TSF02CREU - CREMA

€ 199,00



TSF02PBEU - AZZURRO

€ 199,00



TSF02PGEU - VERDE PASTELLO

€ 199,00



TSF02PKEU - ROSA

€ 199,00



TSF02RDEU - ROSSO

€ 199,00



TSF02BLEU - NERO

€ 199,00



TSF02WHEU - BIANCO

€ 199,00

PROMO SMEG DESIGN
LISTINO 3.499,00 €

PICCOLI ELETTRODOMESTICI

TOSTAPANE 2X2

CARATTERISTICHE TECNICHE:

- Corpo in acciaio verniciato
- Base cromata lucida
- Pomello leva attivazione ciclo in acciaio inox
- Manopola comandi cromata retroilluminata
- Nr. 2 ampi scomparti (36mm ciascuno)
- Centratrice automatica delle fette
- Espulsione automatica a fine ciclo
- Cassetto raccoglibriciole in acciaio inox estraibile
- Vano avvolgicavo integrato
- Piedini antiscivolo
- Potenza 950 W

FUNZIONI

- 6 livelli di doratura
- 3 programmi preimpostati:
- Riscaldamento, Scongelo, Bagel

ACCESSORI ESCLUSI

- TSSR01 - 2 pinze sandwich
- TSBW01 - scaldapanini



TSF01CREU - CREMA

€ 169,00



TSF01PBEU - AZZURRO

€ 169,00



TSF01PGEU - VERDE PASTELLO

€ 169,00



TSF01PKEU - ROSA

€ 169,00

**PROMO SMEG DESIGN
LISTINO 2.999,00 €**



TSF01RDEU - ROSSO

€ 169,00



TSF01BLEU - NERO

€ 169,00



TSF01WHEU - BIANCO

€ 169,00



TSF01GREU - GRAFITE

€ 169,00

CON LA PROMO SMEG DESIGN 2023 PUOI ACQUISTARE,
CON UN SOLO EURO, UN ARTICOLO PED SMEG



CON LA PROMO SMEG DESIGN 2023 PUOI ACQUISTARE,
CON UN SOLO EURO, UN ARTICOLO PED SMEG

PICCOLI ELETTRODOMESTICI

BOLLITORE A TEMPERATURA VARIABILE

CARATTERISTICHE TECNICHE:

- Corpo in acciaio inox
- Base cromata lucida
- Pomello leva attivazione ciclo in acciaio inox
- Beccuccio in acciaio inox
- Maniglia cromata
- 7 livelli di temperatura regolabili (50°C - 100°C)
- Indicazione di temperatura impostata
- Funzione mantenimento temperatura
- Capacità Keep Warm per caraffa 1,7 Lt
- Apertura coperchio con sistema "Soft Opening"
- Doppia visualizzazione livello acqua Lt/Tazze
- Filtro anticalcare in acciaio inox, estraibile
- Spegnimento automatico alla temperatura selezionata raggiunta
- Spegnimento automatico in assenza di acqua
- Base con connessione a 360°
- Resistenza nascosta
- Vano avvolgicavo integrato
- Piedini antiscivolo
- Potenza 2400 W



KLF04CREU - CREMA

€ 199,00



KLF04PBEU - AZZURRO

€ 199,00



KLF04PGEU - VERDE PASTELLO

€ 199,00



KLF04PKEU - ROSA

€ 199,00

**PROMO SMEG DESIGN
LISTINO 3.499,00 €**



KLF04RDEU - ROSSO

€ 199,00



KLF04BLEU - NERO

€ 199,00



KLF04WHEU - BIANCO

€ 199,00

CON LA PROMO SMEG DESIGN 2023 PUOI ACQUISTARE,
CON UN SOLO EURO, UN ARTICOLO PED SMEG

PICCOLI ELETTRODOMESTICI

BOLLITORE STANDARD

CARATTERISTICHE TECNICHE:

- Corpo in acciaio inox
- Base cromata lucida
- Pomello leva attivazione ciclo in acciaio inox
- Beccuccio in acciaio inox
- Maniglia cromata
- Capacità caraffa 1,7 Lt
- Apertura coperchio con sistema "Soft Opening"
- Doppia visualizzazione livello acqua Lt/Tazze
- Filtro anticalcare in acciaio inox, estraibile
- Spegnimento automatico a 100°C
- Spegnimento automatico in assenza di acqua
- Base con connessione a 360°
- Resistenza nascosta
- Vano avvolgicavo integrato
- Piedini antiscivolo
- Potenza 2400 W



KLF03CREU - CREMA

€ 169,00



KLF03PBEU - AZZURRO

€ 169,00



KLF03PGEU - VERDE PASTELLO

€ 169,00



KLF03PKEU - ROSA

€ 169,00

**PROMO SMEG DESIGN
LISTINO 2.999,00 €**



KLF03RDEU - ROSSO

€ 169,00



KLF03BLEU - NERO

€ 169,00



KLF03WHEU - BIANCO

€ 169,00



KLF03GREU - GRAFITE

€ 169,00

PICCOLI ELETTRODOMESTICI

MINI BOLLITORE STANDARD

CARATTERISTICHE TECNICHE:

- Corpo in acciaio inox
- Base cromata lucida
- Pomello leva attivazione ciclo in acciaio inox
- Beccuccio in acciaio inox
- Maniglia cromata
- Funzione mantenimento temperaturat
- Capacità massima 0,8 lt
- Apertura coperchio manuale"
- Spegnimento automatico alla temperatura di 100°C
- Spegnimento automatico in assenza di acqua
- Base con connessione a 360°
- Resistenza nascosta
- Vano avvolgicavo integrato
- Piedini antiscivolo
- Potenza 1400 W



KLF05CREU - CREMA

€ 129,00



KLF05PBEU - AZZURRO

€ 129,00



KLF05PGEU - VERDE PASTELLO

€ 129,00



KLF05PKEU - ROSA

€ 129,00

**PROMO SMEG DESIGN
LISTINO 2.289,00 €**



KLF05RDEU - ROSSO

€ 129,00



KLF05BLEU - NERO

€ 129,00



KLF05WHEU - BIANCO

€ 129,00

CON LA PROMO SMEG DESIGN 2023 PUOI ACQUISTARE,
CON UN SOLO EURO, UN ARTICOLO PED SMEG



PICCOLI ELETTRODOMESTICI

SPREMIAGRUMI

CARATTERISTICHE TECNICHE:

- Corpo in alluminio pressofuso
- Cono universale in acciaio inox
- Filtro in acciaio inox
- Coperchio antipolvere in Tritan™ Renew
- Coperchio antipolvere in Tritan™ (modelli Premium)
- Beccuccio antigoccia in acciaio inox
- Vaschetta raccoglisucco in Tritan™ Renew
- Vano interno porta vaschetta cromato
- Vano avvolgicavo integrato
- Piedini antiscivolo
- Potenza: 70 W



CJF11CREU - CREMA

€ 179,00



CJF11PBEU - AZZURRO

€ 179,00



CJF11PGEU - VERDE PASTELLO

€ 179,00



CJF11PKEU - ROSA

€ 179,00

**PROMO SMEG DESIGN
LISTINO 3.159,00 €**



CJF11RDEU - ROSSO

€ 179,00



CJF11BLEU - NERO

€ 179,00



CJF11WHEU - BIANCO

€ 179,00

CON LA PROMO SMEG DESIGN 2023 PUOI ACQUISTARE,
CON UN SOLO EURO, UN ARTICOLO PED SMEG



CON LA PROMO SMEG DESIGN 2023 PUOI ACQUISTARE, CON UN SOLO EURO, UN ARTICOLO PED SMEG

PICCOLI ELETTRODOMESTICI

PENTOLE

Smeg introduce la sua prima collezione cookware disegnata dallo studio milanese @deepdesign di Raffaella Mangiarotti e Matteo Bazzicalupo e prodotta interamente in Italia. La gamma è pensata per una cucina sana e diversificata. Cucina sana in quanto l'efficace rivestimento antiaderente permette di cucinare riducendo l'utilizzo di oli e grassi e versatile in quanto la gamma si compone di modelli di varie dimensioni e tipologie, per la preparazione di diverse pietanze



CKFC2611BLM - NERO
CASSERUOLA 26 CM

€ 219,00

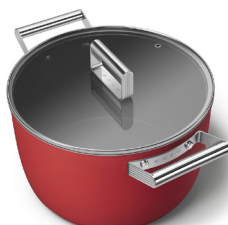

CKFC2611RDM - ROSSA
CASSERUOLA 26 CM

€ 219,00



CKFC2611CRM - CREMA
CASSERUOLA 26 CM

€ 219,00

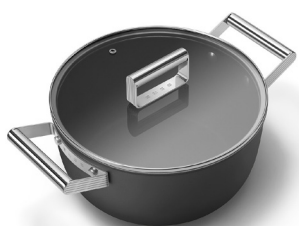

CKFC2411BLM - NERO
CASSERUOLA 24 CM

€ 189,00



CKFC2411RDM - ROSSA
CASSERUOLA 24 CM

€ 189,00



CKFC2411CRM - CREMA
CASSERUOLA 24 CM

€ 189,00



CKFD2811BLM - NERO
PADELLA PROFONDA 28 CM

€ 179,00



CKFD2811RDM - ROSSA
PADELLA PROFONDA 28 CM

€ 179,00



CKFD2811CRM - CREMA
PADELLA PROFONDA 28 CM

€ 179,00



CKFF3001BLM - NERO
PADELLA 30 CM

€ 159,00



CKFF3001RDM - ROSSA
PADELLA 30 CM

€ 159,00



CKFF3001CRM - CREMA
PADELLA 30 CM

€ 159,00



CKFS2011BLM - NERO
CASSERUOLA 20 CM

€ 159,00



CKFS2011RDM - ROSSA
CASSERUOLA 20 CM

€ 159,00



CKFS2011CRM - ROSSA
CASSERUOLA 20 CM

€ 159,00

CON LA PROMO SMEG DESIGN 2023 PUOI ACQUISTARE, CON UN SOLO EURO, UN ARTICOLO PED SMEG

PICCOLI ELETTRODOMESTICI

PENTOLE

Smeg introduce la sua prima collezione cookware disegnata dallo studio milanese @deepdesign di Raffaella Mangiarotti e Matteo Bazzicalupo e prodotta interamente in Italia. La gamma è pensata per una cucina sana e diversificata. Cucina sana in quanto l'efficace rivestimento antiaderente permette di cucinare riducendo l'utilizzo di oli e grassi e versatile in quanto la gamma si compone di modelli di varie dimensioni e tipologie, per la preparazione di diverse pietanze



CKFF2801BLM - NERO
PADELLA 28 CM

€ 149,00



CKFF2801RDM - ROSSA
PADELLA 28 CM

€ 149,00



CKFF2801CRM - CREMA
PADELLA 28 CM

€ 149,00



CKFF2601BLM - NERO
PADELLA 26 CM

€ 139,00



CKFF2601RDM - ROSSA
PADELLA 26 CM

€ 139,00



CKFF2601CRM - CREMA
PADELLA 26 CM

€ 139,00



CKFW3001BLM - NERO
WOK 30 CM

€ 169,00



CKFW3001RDM - ROSSA
WOK 30 CM

€ 169,00



CKFW3001CRM - CREMA
WOK 30 CM

€ 169,00



CKFF2401BLM - NERO
PADELLA 24 CM

€ 129,00



CKFF2401RDM - ROSSA
PADELLA 24 CM

€ 129,00



CKFF2401CRM - CREMA
PADELLA 24 CM

€ 129,00



CKFL2801
COPERCHIO 28 CM

€ 59,00



CKFL3001
COPERCHIO 30 CM

€ 59,00



CKFL2401
COPERCHIO 24 CM

€ 59,00



CKFL2601
COPERCHIO 26 CM

€ 59,00

ACCESSORI PICCOLI ELETTRODOMESTICI

WATER BOTTLE

BGF02



Bottle to go

29,00 €

TOSTAPANE | ACCESSORI OPZIONALI

TSBW01



Scalda pane/
griglia portafette
per TSF01

19,00 €

TSBW02



Scalda pane/
griglia portafette
per TSF02

24,00 €

TSSR01



2 pinze per toast
per TSF01 e TSF03

29,00 €

TSSR02



2 pinze per toast
per TSF02

39,00 €

MACCHINA PER CAFFÈ FILTRO | ACCESSORI OPZIONALI

DCGC01



Caraffa in vetro

29,00 €

FRULLATORE | ACCESSORI OPZIONALI

BGF01



Bottle to go
con gruppo lame

39,00 €

FRULLATORE A IMMERSIONE | ACCESSORI OPZIONALI

HBAC11RD - ROSSO
HBAC11CR - CREMA
HBAC11BL - NERO
HBAC11PB - AZZURRO



Kit accessori

59,00 €

HBFP11



Food processor

119,00 €











HBHD11

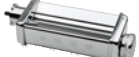

Solo supporto

29,00 €

IMPASTATRICE | ACCESSORI OPZIONALI

SMGB01		Ciotola in vero 4,8 L	119,00 €
SMB401		Ciotola in acciaio 4,8 L	99,00 €
SMFB02		Frusta con bordi flessibili	59,00 €
SMIC02		Contenitore aggiuntivo gelatiera con coperchio	89,00 €
SMPC01		Set accessori pasta	199,00 €
SMPRO1		Accessorio sfoglia	89,00 €
SMMG01		Accessorio tritatutto	89,00 €
SMMSG01		Accessorio tagliaverdure a cilindro	89,00 €
SMFB01		Frusta piatta	29,00 €
SMDH01		Gancio impastatore	29,00 €
SMWW02		Frusta filo	39,00 €
SMPS01		Coperchio versatore anti-spruzzo	29,00 €

CONDIZIONI GENERALI DI VENDITA

1 - PREZZI

Il presente listino annulla e sostituisce il precedente.

I prezzi elencati sono da considerarsi al netto di IVA, trasporto ed eventuale Eco - contributo RAEE.

2 - ILLUSTRAZIONI E DESCRIZIONI

Le illustrazioni e le descrizioni possono essere soggette a modifiche da parte dei produttori senza preavviso e senza possibilità di rivendicazione da parte dell'Acquirente. I colori reali dei materiali potrebbero differire da quelli presenti nel catalogo.

3 - PAGAMENTI

I pagamenti vengono riconosciuti validi solamente se eseguiti direttamente al Fornitore o a terzi da esso autorizzati per iscritto.

Anche in caso di opportuna contestazione comunque i pagamenti non possono essere sospesi.

Per i ritardi nei pagamenti saranno addebitati gli interessi di mora determinati ai sensi del D.Lgs. 9/10/2002 n.231 dalla data della fattura, oltre alle spese amministrative forfetarie pari a € 25,00+IVA nel caso di effetti tornati insoluti o protestati.

N.B. Detti interessi sono quelli dovuti nel caso di ritardato pagamento nelle transizioni commerciali e determinati sulla base di una maggiorazione del 7% in aggiunta al tasso legale disposto dalla BCE.

4 - EMISSIONI DI EFFETTI

Per ogni scadenza verranno addebitate le spese bancarie di incasso.

5 - TRASPORTI

Eventuali contestazioni sulla quantità o qualità della merce verranno accettate solo se presentate al momento dello scarico ed annotate sul DDT.

6 - TERMINI DI CONSEGNA

I termini di consegna hanno valore puramente indicativo, non si accettano penalità per ritardata consegna.

7 - SOSTITUZIONI E RESI

Prima di procedere all'installazione dei prodotti verificare che tutti i componenti non siano danneggiati. In caso contrario contattare il rivenditore e non proseguire con l'installazione.

Gli eventuali difetti estetici non potranno essere contestati ad oggetto già installato ed in mancanza di imballaggio originale.

Non sono ammessi resi di merce non preventivamente autorizzati per iscritto dal Fornitore.

8 - CONSEGNE

Il Fornitore si riserva il diritto di sospendere le consegne in qualunque caso di inadempienza, anche parziale, dell'acquirente agli obblighi assunti.

9 - FORO

Per ogni controversia il foro esclusivamente competente è quello del Fornitore.

Ai sensi e per gli effetti degli articoli 1341 - 1342 Codice Civile, il Contraente sottoscrive specificatamente le condizioni riportate a i punti: n. 5 - trasporti, n. 6 - termini di consegna, n. 7 - sostituzioni e resi, n. 8 - consegne, n. 9 - foro.

Il Fornitore declina ogni responsabilità per eventuali inesattezze dovute a errori di trascrizione o stampa del presente catalogo.

Tutti i dati e le descrizioni esposti nel presente catalogo possono essere variati o annullati in qualunque momento secondo le esigenze tecniche e commerciali della ditta produttrice e ciò senza obbligo di preavviso e senza possibilità di rivendicazione da parte dell'acquirente, negoziante o privato.

INCASSO S.r.l. si riserva di apportare senza preavviso tutte le modifiche che riterrà utili al miglioramento dei propri prodotti.

Le illustrazioni, i dati e le descrizioni contenuti in questo catalogo non sono quindi impegnativi ed hanno solo valore indicativo.

Per una corretta installazione è indispensabile consultare le istruzioni tecniche in dotazione a ciascun apparecchio.



INCASSO

Incasso S.r.l.
Via C. Brunetto 88 - Fraz. Ceretta - 10077
San Maurizio C.se - To
Tel. 011.9279570 - Fax. 011.0880876
www.incasso.it - incasso@incasso.it