

KITCHEN EXPERIENCE

**PLADOS**

LISTINO PREZZI 2024 - 2025



# INDICE GENERALE



AZIENDA	8
LAVELLI	40
Selezione Rinnova	42
Contempo	54
Lux	60
Cosmo	68
One	74
Elegance	100
Infinity	108
Corax	114
Atlantic	122
Spazio	130
Harmony	138
LAVELLI INOX	146
ACCESSORI	162
MISCELATORI	180
FORNI	220
PIANI COTTURA A INDUZIONE	228
PIANI COTTURA A GAS	234
GAMMA COLORI	246

90 cm

80 cm

60 cm

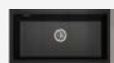

















**CONTEMPO/  
LUX****CT9010**  
Pag. 58**LX8610**  
Pag. 64**LX8620**  
Pag. 66**COSMO****C07510**  
Pag. 72**C05510**  
Pag. 72**ONE**Installazione  
standard**ON8420**  
Pag. 78**ON8410**  
Pag. 78**ON8620**  
Pag. 79**ON7920**  
Pag. 79**ON7610**  
Pag. 80**ON6910**  
Pag. 80**ON6010**  
Pag. 81**ON5610**  
Pag. 81**ON6010**  
Pag. 81**ONE**Installazione  
sotto-top**ON8420ST**  
Pag. 88**ON8410ST**  
Pag. 88**ON7920ST**  
Pag. 89**ON7610ST**  
Pag. 90**ON6910ST**  
Pag. 91**ON5610ST**  
Pag. 92**AM8620ST**  
Pag. 89**LX8610ST**  
Pag. 90**ON6010ST**  
Pag. 91**ONE**Installazione  
integrata**ON7610IT**  
Pag. 98**ON5610IT**  
Pag. 98**ELEGANCE****AM8620**  
Pag. 105**AM11620**  
Pag. 104**AM9915**  
Pag. 104**AM9910**  
Pag. 105**AM7815**  
Pag. 107**INFINITY****NF11620**  
Pag. 112**NF9910**  
Pag. 112**NF8610**  
Pag. 113**CORAX****CX0862**  
Pag. 119**CX1162**  
Pag. 118**CX0991**  
Pag. 118**EL9910**  
Pag. 119**ATLANTIC****PL1162**  
Pag. 126**PL0862**  
Pag. 127**AT1162**  
Pag. 126**SPAZIO****SP0862**  
Pag. 134**SP1162**  
Pag. 134**SP0792**  
Pag. 135**HARMONY****HR0860**  
Pag. 143**DB09910**  
Pag. 142**PL11610**  
Pag. 142**DB09910**  
Pag. 142

50 cm



























45 cm

40 cm

Angolare

50 cm	45 cm	40 cm	Angolare	
				<b>CONTEMPO/ LUX</b>
 <b>C04510</b> Pag. 73	 <b>C04510</b> Pag. 73			<b>COSMO</b>
	 <b>ON4110</b> Pag. 82			<b>ONE</b> Installazione standard
	 <b>ON4110ST</b> Pag. 92			<b>ONE</b> Installazione sotto-top
				<b>ONE</b> Installazione integrata
   <b>AM8610</b> <b>AM7810</b> <b>AM6510</b> Pag. 106 Pag. 106 Pag. 107				<b>ELEGANCE</b>
				<b>INFINITY</b>
	  <b>CX0861</b> <b>CX0791</b> Pag. 120 Pag. 120			<b>CORAX</b>
	 			<b>ATLANTIC</b>
	  <b>SP0861</b> <b>SP0791</b> Pag. 135 Pag. 136			<b>SPAZIO</b>
 <b>HR4321</b> Pag. 143  Installazione longitudinale	  <b>HR4321</b> <b>NK05110</b> Pag. 143 Pag. 144  Installazione standard		 <b>HRA832</b> Pag. 144  Inseribile anche in 2 basi rettangolari da 90 cm	<b>HARMONY</b>

# LAVELLI IN ACCIAIO INOX

	90 cm	80 cm	60 cm	50 cm	45 cm	Angolare
<b>MAKI MIX-R</b> Installazione slim/filo-top		 <b>SR7520</b> Pag. 151  <b>SR7500</b> Pag. 151	 <b>SR5500</b> Pag. 151		 <b>SR3900</b> Pag. 151	
<b>MAKI-R</b> Installazione slim/filo-top		 <b>MR7420</b> Pag. 153  <b>MR7400</b> Pag. 153	 <b>MR5400</b> Pag. 153		 <b>MR3800</b> Pag. 153	
<b>MAKI ST-R</b> Installazione sotto-top		 <b>SL7420</b> Pag. 155  <b>SL7400</b> Pag. 155	 <b>SL5400</b> Pag. 155		 <b>SL3800</b> Pag. 155	
<b>OLYMPUS/ VINTAGE</b>	 <b>C008620</b> Pag. 157	 <b>C01162</b> Pag. 157  <b>VI1001</b> Pag. 157  <b>C007920</b> Pag. 158  <b>VI08600</b> Pag. 158	 <b>VI1001</b> Pag. 157		 <b>C00861</b> Pag. 157  <b>C00791</b> Pag. 158  <b>LISP000431S</b> Pag. 158  <b>LISP504410S60</b> Pag. 159	 <b>LISP838320S</b> Pag. 159  <b>VIA832</b> Pag. 159
<b>UNIVERSAL</b>	 <b>TL08620</b> Pag. 161	 <b>TL1162</b> Pag. 161			 <b>TL0861</b> Pag. 161	

## ACCESSORI



**COPRIVASCA  
IN HPL**  
pag. 166



**ACCESSORI  
COORDINATI**  
pag. 167-171



**ACCESSORI  
DESIGN**  
pag. 173



**TAGLIERI IN LEGNO,  
POLIETILENE,  
CRISTALLO**  
pag. 174-175



**VASCHETTE  
IN POLICARBONATO  
E ACCIAIO INOX**  
pag. 176



**TRITARIFIUTI**  
pag. 177



**PRODOTTI PER  
LA PULIZIA**  
pag. 178



**ALTRI ACCESSORI**  
pag. 179

## MISCELATORI



**SORGENTE 1**  
pag. 187



**SORGENTE 2**  
pag. 187



**FLO55**  
pag. 188



**FLO60**  
pag. 188



**KIT FILTRANTE**  
pag. 189



**POLYTEK10**  
pag. 191



**POLYTEK20**  
pag. 191



**HEGO**  
pag. 192



**SHOWERMID**  
pag. 192



**SPRINGP30**  
pag. 194



**SPRINGP40**  
pag. 194



**NEWMIX80**  
pag. 196



**NEWMIX90**  
pag. 196



**NEWMIX30**  
pag. 198



**MIG10**  
pag. 198



**SPIRIT**  
pag. 200



**NILO**  
pag. 200



**NEMO**  
pag. 202



**COLONNA**  
pag. 204



**HYDRA**  
pag. 206



**VEMIXEXTL**  
pag. 206



**PARMIXEXT**  
pag. 208



**PUNTOBPEX**  
pag. 208



**VENMIXEXT**  
pag. 210



**TIZMIXEXT**  
pag. 210



**SLIMFIX**  
pag. 211



**VENMIXL**  
pag. 211



**TIZEK**  
pag. 212



**EASY**  
pag. 212



**PETRAMIX**  
pag. 213



**VENMIX20**  
pag. 213



**EUROMIX**  
pag. 214



**NEOMIX**  
pag. 214



**PLUSMIX**  
pag. 215



**PLUSMIXEXT**  
pag. 215



**WINMIX**  
pag. 216



**NOVOMIX**  
pag. 216



**MIXOLDST**  
pag. 216



**MIXOLD**  
pag. 218



**IDEAOLD**  
pag. 218

## ELETTRODOMESTICI



**FIDIG**  
pag. 224



**FIMOD**  
pag. 225



**FITER**  
pag. 226



**PBIL320C**  
pag. 232



**PBIM430**  
pag. 232

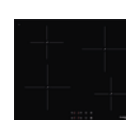

**PBIM640C**  
pag. 233



**GLASS75**  
pag. 238



**GLASS60**  
pag. 238



**SLIM75**  
pag. 239



**FLAT75**  
pag. 240



**FLAT60**  
pag. 241



**STAR75**  
pag. 242



**STAR60**  
pag. 243



**30 ANNI  
DI STORIA  
E DI TERRITORIO**



# LE NOSTRE **RADICI - LE MARCHE**

30 ANNI DI STORIA E DI TERRITORIO

Il *chi* e il *come* sono importanti ma anche il *dove* conta. Il nostro *dove* è l'infinito naturale delle Marche; è appartenenza alla lunga tradizione d'eccellenza del "saper fare" delle mani, a un'operosità generosa e tenace.

Essere qui e non altrove ha fatto la differenza, perché siamo parte integrante di questa geografia fisica e umana, perché l'appartenenza è una relazione tra azienda e territorio che genera valore in termini di sviluppo e competitività e crea beneficio alla comunità in termini di benessere e qualità della vita. Essere nel territorio e non sul territorio, scegliere una terra buona nella quale mettere radici ha significato potersi nutrire di quanto essa offre, crescere e svilupparsi in modo solido.

# RICERCA E SVILUPPO

## UNA VISIONE DI FUTURO



Avere una visione significa immaginare il futuro che vogliamo contribuire a creare per noi e per gli altri, facendo pratica dei valori, degli ideali e dei desideri che ci distinguono.

Nella nostra visione di futuro, la conoscenza è la stella che guida il nostro cammino. Non c'è innovazione senza conoscenza, non c'è cambiamento o miglioramento concreto che possa riguardare la progettazione, la produzione e la vendita di beni se non con l'impegno a fare della conoscenza un processo continuo di ricerca e scoperta.

30 anni di Plados sono stati questo, una tensione fino a quell'orizzonte e poi un altro e un altro ancora, senza smettere mai di pensare che si può fare meglio di come abbiamo fatto.



↓  
**3500 M<sup>2</sup>  
DEDICATI**





↓  
**250 PERSONE  
NEL MONDO  
LAVORANO  
PER PLADOS**



# PERSONE E VALORI

## DARE SENSO ALL'IMPRESA



Le persone che hanno le competenze fanno di un'azienda una grande azienda; le persone che hanno le competenze e la passione fanno di un'azienda un progetto. E sono le persone, la loro mentalità, la loro capacità di combinare mezzi e risorse a realizzare quel progetto.

Le nostre persone, ciascuna di loro, sono orientate da un progetto comune e impegnate nella sua realizzazione: ogni persona che in questi 30 anni di storia ha scelto di fare suoi i nostri valori e condividere la nostra idea di essere e fare impresa, si è dedicata con entusiasmo e impegno costante, è un patrimonio prezioso, una risorsa strategica, un facilitatore della nostra visione di futuro. Tutte le persone di Plados, ciascuna con le proprie competenze, sono la condizione necessaria per dare senso al fare impresa.

# RIVOLUZIONE **GREEN**

## IL FUTURO È NELLE MANI DI TUTTI

Oltre all'impegno per ridurre i consumi di energia, Plados ha introdotto misure per coprire il proprio fabbisogno energetico tramite fonti rinnovabili. L'azienda ha recentemente installato un impianto fotovoltaico sui tetti dei propri stabilimenti. L'energia solare generata da tale impianto eviterà l'emissione di 300 tonnellate di anidride carbonica ogni anno. Si può stimare che sarebbero necessari circa 20.000 Alberi per assorbire la suddetta quantità di CO<sub>2</sub> evitata.

Fino al  
**40%**

Consumi elettrici coperti  
dal fotovoltaico.

**300**

300 Tonnellate/anno  
di emissioni CO<sub>2</sub> in meno.

**20.000**

Alberi necessari per  
assorbire la CO<sub>2</sub> evitata.



↓  
**40%**  
**AUTOPRODUZIONE**



# RIVOLUZIONE **GREEN**

LA MATERIA PRIMA, I PROCESSI PRODUTTIVI,  
LE RISORSE, IL PRODOTTO

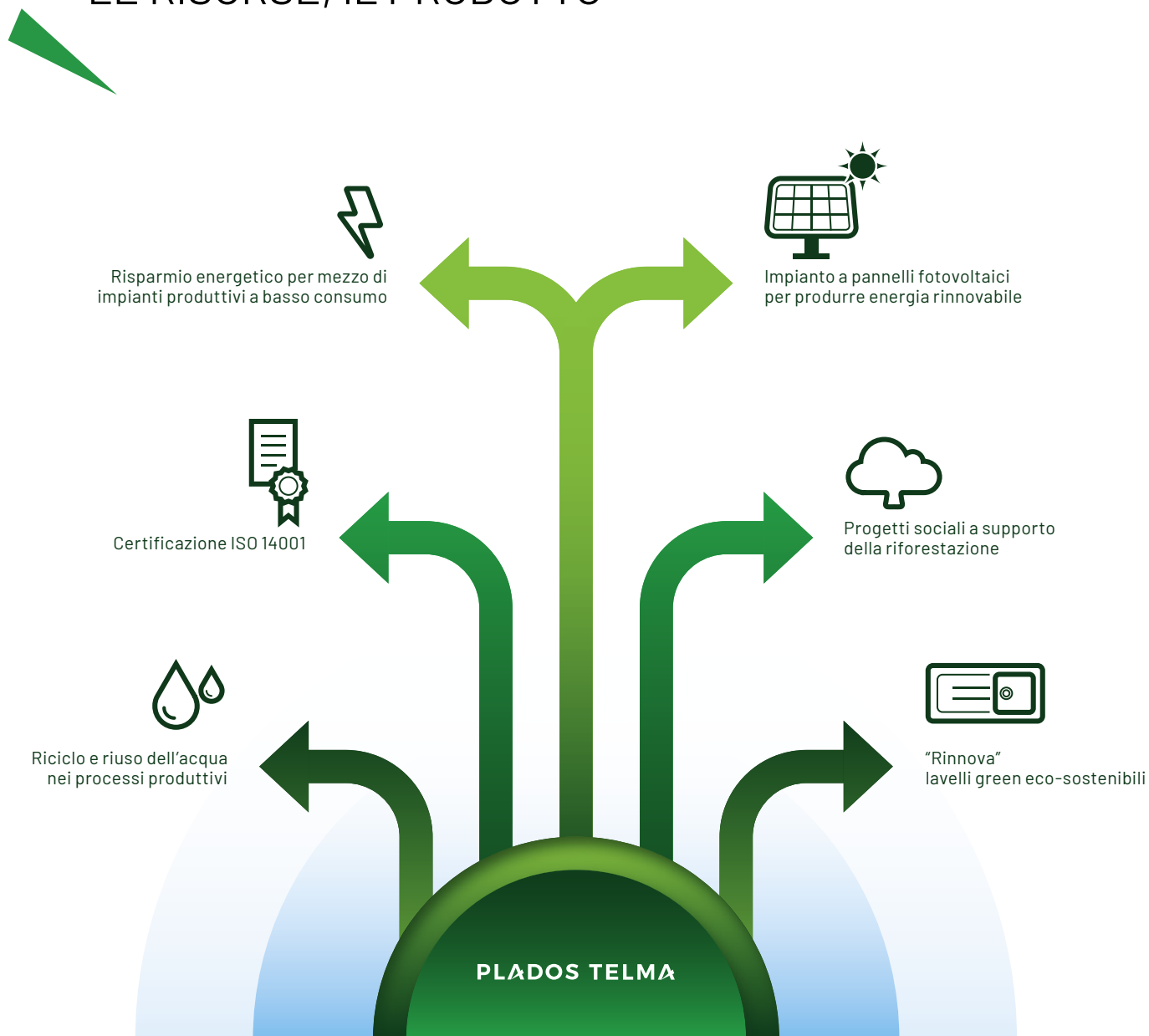

Natura, persone ed economia sono i termini connessi e interdipendenti di una stessa relazione; agire per l'ambiente significa generare crescita di valore per le comunità di tutto il mondo. Per questa ragione, l'impegno green di Plados Telma investe l'origine della materia prima, i processi produttivi, l'impiego efficiente delle risorse energetiche e idriche, il prodotto e il suo ciclo di vita; per costruire una sostenibilità d'impresa, per l'ambiente e per le persone.







**ISO 14001  
GARANTISCE  
PER CHI  
CI SCEGLIE**

# IL NOSTRO IMPEGNO **CERTIFICATO** SECONDO LO STANDARD INTERNAZIONALE DEL SISTEMA DI GESTIONE AMBIENTALE



Le certificazioni rappresentano un elemento fondamentale del nostro fare impresa perché costituiscono una garanzia di rispetto delle normative di legge, sia per noi che per le persone che ci scelgono.

La ISO14001 certifica che Plados è dotata di un sistema di gestione adeguato al controllo dell'impatto ambientale delle proprie attività e certifica l'impegno costante dell'azienda a migliorare quell'impatto in modo efficace e sostenibile. La certificazione ISO14001 non è obbligatoria, ma è frutto della scelta volontaria dell'azienda che decide di definire, attuare, mantenere e migliorare un proprio sistema di gestione ambientale.

L'anima green di Plados corre lungo tutta la catena del valore, dall'approvvigionamento della materia prima alla realizzazione di prodotti che consentono di risparmiare sulle risorse idriche ed energetiche. Chi sceglie Plados può contare sulle nostre buone pratiche ambientali.

# PLADOS **ARIAPURA**

## LA TECNOLOGIA CHE PORTA IL CIELO IN CUCINA

Il materiale dei lavelli Plados è addizionato con nanoparticelle di biossido di titanio ( $\text{TiO}_2$ ) che oltre a contribuire alla purificazione dell'aria nell'ambiente cucina, svolge un'azione antibatterica rendendo il lavello più fresco e più pulito. Ariapura è presente in tutta la massa del lavello, ha una durata illimitata, resta attiva e conserva la sua completa efficacia nel tempo anche in caso di usura e graffio delle superfici.

Tutti i lavelli Plados sono provvisti della tecnologia brevettata ariapura che svolge una triplice azione:

- Antinquinante
- Antibatterica
- Autopulente

**BREVETTO INTERNAZIONALE  
PCT/EP2012 /065120**



**AZIONE  
ANTINQUINANTE  
ANTIBATTERICA  
AUTOPULENTE**



# NUOVE ESPERIENZE IN CUCINA

# PLADOS: KITCHEN **EXPERIENCE** COME CAMBIA L'APPROCCIO AL QUOTIDIANO



Kitchen experience è la nostra filosofia dell'abitare gli spazi domestici: progettiamo e realizziamo prodotti per cucine che possano essere vissute come luogo d'incontro e socialità, belli da vedere e funzionali, capaci di durare nel tempo, accessibili a tutti, perché la qualità è un lusso che tutti devono potersi permettere; rispettosi dell'ambiente, perché le nostre case confinano con una casa più grande, il nostro pianeta.

Kitchen experience riassume il nostro impegno a migliorare concretamente lo stile di vita delle persone, perché il tempo trascorso in cucina e ogni gesto siano esperienza di buona vita, benessere, salute, cura e attenzione, per noi e la natura. Kitchen experience è il nostro contributo a un futuro migliore, per tutti.





# CONTEMPO

COUNTRY REIMAGINED



# NUOVI MISCELATORI

DESIGN & RISPARMIO ENERGETICO



MISCELATORI  
**A TRE VIE:**  
ADDIO BOTTIGLIE DI PLASTICA



# LAVELLO WORKSTATION

## TUTTO SOTTO CONTROLLO

Il lavello workstation è una vera e propria postazione di lavoro, più spaziosa, pratica e funzionale grazie agli accessori integrati studiati ad hoc: cestelli, vaschette, taglieri, dispenser e molto altro. I materiali e le finiture di pregio fanno del lavello workstation un elemento di arredo capace di aggiungere valore estetico alla cucina. LX8610 è la risposta di Plados al desiderio di trasformare la cucina in un luogo di esperienza, nel quale design e funzionalità si uniscono per migliorare la qualità del tempo che vi trascorriamo.



ROLLMAT

Un gocciolatoio pieghevole con barre a sezione rettangolare, per una maggiore stabilità. Disponibile in 4 finiture.

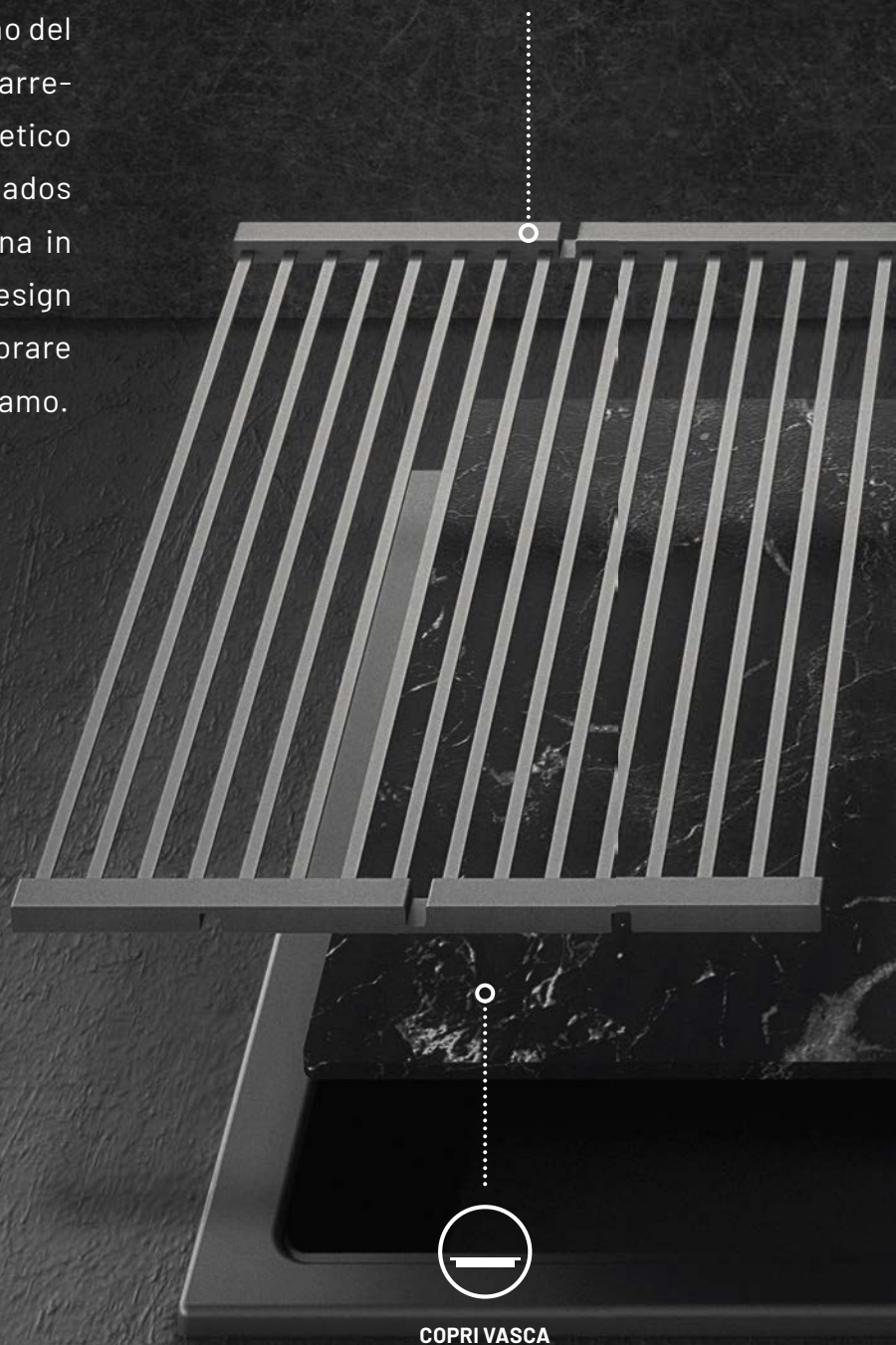

COPRI VASCA

Una pratica superficie aggiuntiva, utile durante la preparazione dei cibi, ideale per i lavelli sprovvisti di gocciolatoio.



#### DISPENSER SAPONE LIQUIDO

Si installa in uno dei prefori presenti nel lavello. Una soluzione di design pratica e funzionale.



#### VASCHETTA IN POLICARBONATO

Progettata per scorrere sulle guide dei lavelli LUX, un accessorio pratico ed elegante, sempre utile nella preparazione dei cibi.



#### PILETTA PVD

Una finitura high-tech raffinata e resistente.

TRASFORMA LA TUA CUCINA

# FINITURE PVD

PVD è l'acronimo di Physical Vapor Deposition, una tecnologia che consente di depositare un rivestimento metallico su diversi tipi di superfici. I rivestimenti in PVD oltre ad avere eccezionali caratteristiche estetiche, sono particolarmente indicati per tutti quei prodotti che necessitano di elevate prestazioni di resistenza all'abrasione, al graffio e alla corrosione.

Le nuovissime finiture metalliche in PVD permettono di creare abbinamenti di altissimo pregio tra pilette, miscelatori e accessori di design.



PVD - ORO



PVD - RAME



PVD - GUN METAL





Il nuovissimo miscelatore NEMO (pag. 202) è disponibile anche in 3 finiture PVD abbinabili sia ai KIT piletta e troppopieno PVD, che all'accessorio ROLLMAT, sempre in tinta.





I coordinati rappresentano l'unione tra funzionalità ed estetica: materiali, forme e colori dialogano in equilibrio perfetto e fanno della cucina un'esperienza anche sensoriale, tutta da vivere.





**COORDINATI**  
L'EQUILIBRIO TRA  
FUNZIONALITÀ ED ESTETICA

# LAVELLO + RUBINETTO + ELETTRODOMESTICI COORDINATI PER **AMBIENTAZIONI CLASSICHE**

Abbinamenti **colore dei lavelli e rubinetti** Plados  
con piani cottura e forni dei principali fabbricanti di **elettrodomestici**

## FINITURE PLADOS



microULTRAGRANIT  
56 Jasmine



microULTRAGRANIT  
70 Nero Matt



microULTRAGRANIT  
90 Bianco Opale



microULTRAGRANIT  
94 Avena

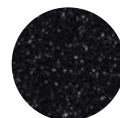

microULTRAGRANIT  
95 Nero Ebony

COLORI DEI  
PRINCIPALI  
FABBRICANTI DI  
ELETTRODOMESTICI

<b>HOTPOINT</b>	OW BIANCO ANTICO	AN ANTRACITE	GW GRANITO BIANCO	AV AVENA	
<b>INDESIT</b>		AN ANTRACITE		AV AVENA	
<b>ELECTROLUX</b>	PBA BIANCO ANTICO	• PN NERO GHISA • NERO	PP PIETRA	PS SABBIA	PL LAVA
<b>WHIRLPOOL</b>	BIANCO ANTICO	ANTRACITE		AVENA	
<b>SMEG</b>	PANNA	ANTRACITE NERO		AVENA	
<b>CANDY</b>	BA BIANCO ANTICO	• GH GHISA • N NERO		AV AVENA	PL LAVA
<b>FRANKE</b>		NERO	BIANCO	AVENA	GRAFITE
<b>TELMA</b>	TG 51 JASMINE	TG 26 NERO MATT	TG 31 BIANCO	TG 29 AVENA	TG 30 NERO
<b>BEKO</b>		• ANTRACITE • NERO		AVENA	
<b>FOSTER</b>	AVORIO	ANTRACITE		AVENA	
<b>DE'LONGHI</b>		ANTRACITE		• AVENA • SABBIA	
<b>GLEM GAS</b>		• ANTRACITE • NERO		SABBIA	

# LAVELLO + RUBINETTO + ELETTRODOMESTICI COORDINATI PER **AMBIENTAZIONI MODERNE**

Abbinamenti **colore dei lavelli e rubinetti** Plados  
con piani cottura e forni dei principali fabbricanti di **elettrodomestici**

## FINITURE PLADOS



microULTRAGRANIT 98 Bianco    microULTRAGRANIT 70 Nero Matt    microULTRAGRANIT 72 Tartufo    ULTRAMETAL 41 Alluminio    ULTRAMETAL 42 Titanio    ULTRAMETAL 44 Nero    nanoSTONE N1 Bianco Latte    nanoSTONE N6 Deep Black

COLORI DEI  
PRINCIPALI  
FABBRICANTI DI  
ELETTRODOMESTICI

<b>HOTPOINT/ ARISTON</b>	• WH BIANCO • CRISTALLO BIANCO	• MR SPECCHIO • CRISTALLO NERO	DS DESERT SAND	• SL ARGENTO • INOX	• IC ICE • INOX	• MR SPECCHIO • INOX	CRISTALLO BIANCO	CRISTALLO NERO
<b>INDESIT</b>	• WH BIANCO • VETRO BIANCO	• BK NERO • VETRO NERO	TD TORTORA	INOX	• GR GRAFITE • INOX	• BK NERO • INOX	VETRO BIANCO	VETRO NERO
<b>ELECTROLUX/ REX</b>	• BIANCO • CRISTALLO BIANCO	• NERO • CRISTALLO NERO		INOX	INOX	• SPECCHIO • INOX	VETRO BIANCO	VETRO NERO
<b>WHIRLPOOL</b>	• BIANCO VETRO BIANCO	• ANTRACITE • VETRO NERO	VETRO TORTORA	• VETRO SILVER • INOX	INOX	• VETRO SPECCHIO • INOX	VETRO BIANCO	VETRO NERO
<b>SMEG</b>	• BIANCO • VETRO BIANCO	• ANTRACITE • VETRO NERO		• VETRO SUPERSILVER • INOX	INOX	INOX	VETRO BIANCO	VETRO NERO
<b>CANDY</b>	• W BIANCO • CRISTALLO BIANCO	• N NERO • CRISTALLO NERO		• SPARK AQUA • INOX	INOX	• CRISTALLO SPECCHIO • INOX	VETRO BIANCO	VETRO NERO
<b>FRANKE</b>	• BIANCO • CRISTALLO BIANCO	• NERO • CRISTALLO NERO	CRISTALLO CHAMPAGNE	• ALLUMINIO • INOX	INOX	• MIRROR NERO • INOX	CRISTALLO BIANCO	MIRROR NERO
<b>TELMA</b>	TG 28 BIANCO LATTE	TG 26 NERO MATT	TG 54 TARTUFO	• MQ 71 ALLUMINIO	• MQ 72 TITANIO	INOX		
<b>BEKO</b>		• ANTRACITE • NERO		INOX	INOX	INOX		
<b>FOSTER</b>	BIANCO	ANTRACITE		INOX	INOX	INOX		
<b>DE'LONGHI</b>	BIANCO	NERO	TORTORA	INOX	• SPECCHIO • INOX	INOX		
<b>GLEM GAS</b>	• BIANCO • CRISTALLO BIANCO	• NERO • CRISTALLO NERO		• ALLUMINIO • INOX	INOX	INOX	CRISTALLO BIANCO	CRISTALLO NERO
<b>IGNIS</b>	BIANCO	NERO	TORTORA	INOX	INOX	INOX		
<b>SIEMENS</b>	• BIANCO • VETRO BIANCO	• NERO • VETRO NERO		INOX	INOX	INOX	VETRO BIANCO	VETRO NERO
<b>BOSCH</b>	• BIANCO • VETRO BIANCO	• NERO • VETRO NERO		INOX	INOX	INOX	VETRO BIANCO	VETRO NERO



# FINITURE E QUALITÀ

## DEI PRODOTTI PLADOS



Plados ha messo al centro la qualità del prodotto e ha voluto renderla accessibile a tutti. Un impegno che ci ha permesso di ottenere importanti riconoscimenti a livello nazionale e internazionale e soprattutto la fiducia dei nostri clienti.

Produrre oggetti di qualità risponde anche a una precisa filosofia dell'abitare, coerente con la salute delle persone e dell'ambiente. L'intera catena del valore, la ricerca e l'impiego di tecnologie e materiali innovativi, riflettono la volontà di ridurre l'impatto dei processi produttivi e allungare il ciclo di vita degli oggetti: un gesto di cura e di rispetto per il pianeta e per le persone a cui sono destinati i nostri prodotti.

Plados produce lavelli di ottima qualità destinati a durare nel tempo con la convinzione che la durabilità sia un aspetto della qualità da cui non si può prescindere.

## FINITURE E QUALITÀ / RINNOVA



Attraverso un processo di **rigenerazione delle materie prime di recupero**, abbiamo ottenuto un composto green all'origine che garantisce le stesse caratteristiche chimiche, fisiche, meccaniche ed estetiche rispetto al composto tradizionale dei lavelli Plados. Il nostro obiettivo era **massimizzare l'impiego di queste risorse, altrimenti destinate alla discarica**, così da non ricorrere a materie prime vergini. La qualità del prodotto finale è identica, la differenza la fa l'origine della materia prima, **i lavelli Rinnova sono composti da più del 90% di componenti rinnovabili**.



## FINITURE E QUALITÀ / NANOSTONE



NanoSTONE è composto da resina acrilica purissima e da un mix di cariche minerali high-tech, progettate per legarsi tra loro sviluppando un reticolo 3D di "legami idrogeno", mediante un processo chimico possibile grazie alle geometrie e alla polarizzazione dei minerali coinvolti. La rete molecolare così creata, **fortifica la struttura interna del lavello, rendendolo più resistente agli urti ed agli shock termici**. Il nuovo materiale composito ha una struttura più robusta e una sensazione di piacevolezza al tatto.

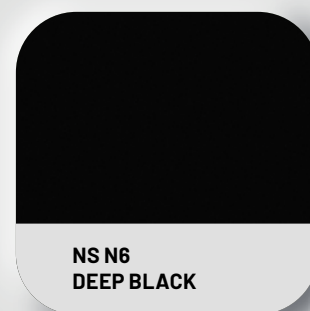
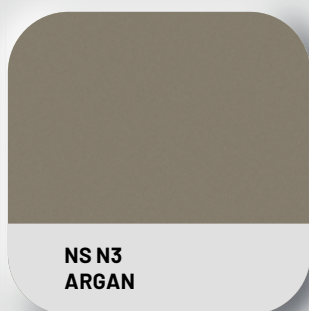
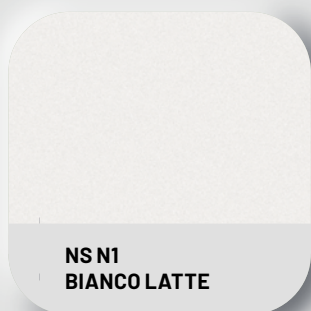

## FINITURE E QUALITÀ / **ULTRAMETAL**

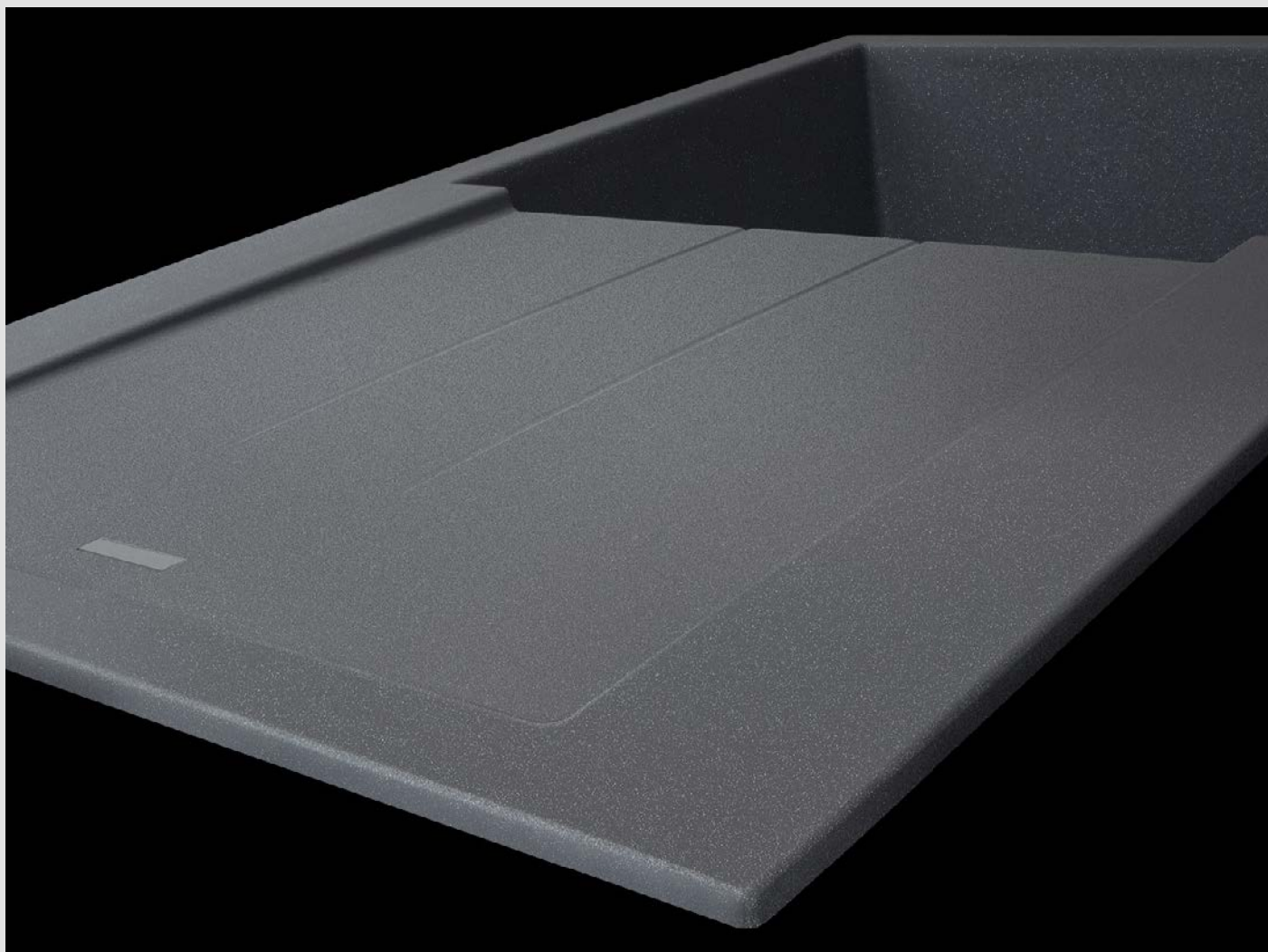

Le **particelle metallescenti**, presenti nella miscela assieme a cristalli di quarzo e granito, creano nelle superfici del lavello **tonalità e finiture metallizzate**. Colorazioni fredde, superfici satinata ed effetto metallescente rendono il lavello in Ultrametal particolarmente idoneo per **ambientazioni moderne** e per abbinamenti con elettrodomestici in acciaio inox, spesso presenti in cucina. Un lavello in Ultrametal è facile da pulire, molto igienico e resistente ai graffi, agli agenti chimici, al calore ed alle alte temperature.





# FINITURE E QUALITÀ / MICROULTRAGRANIT

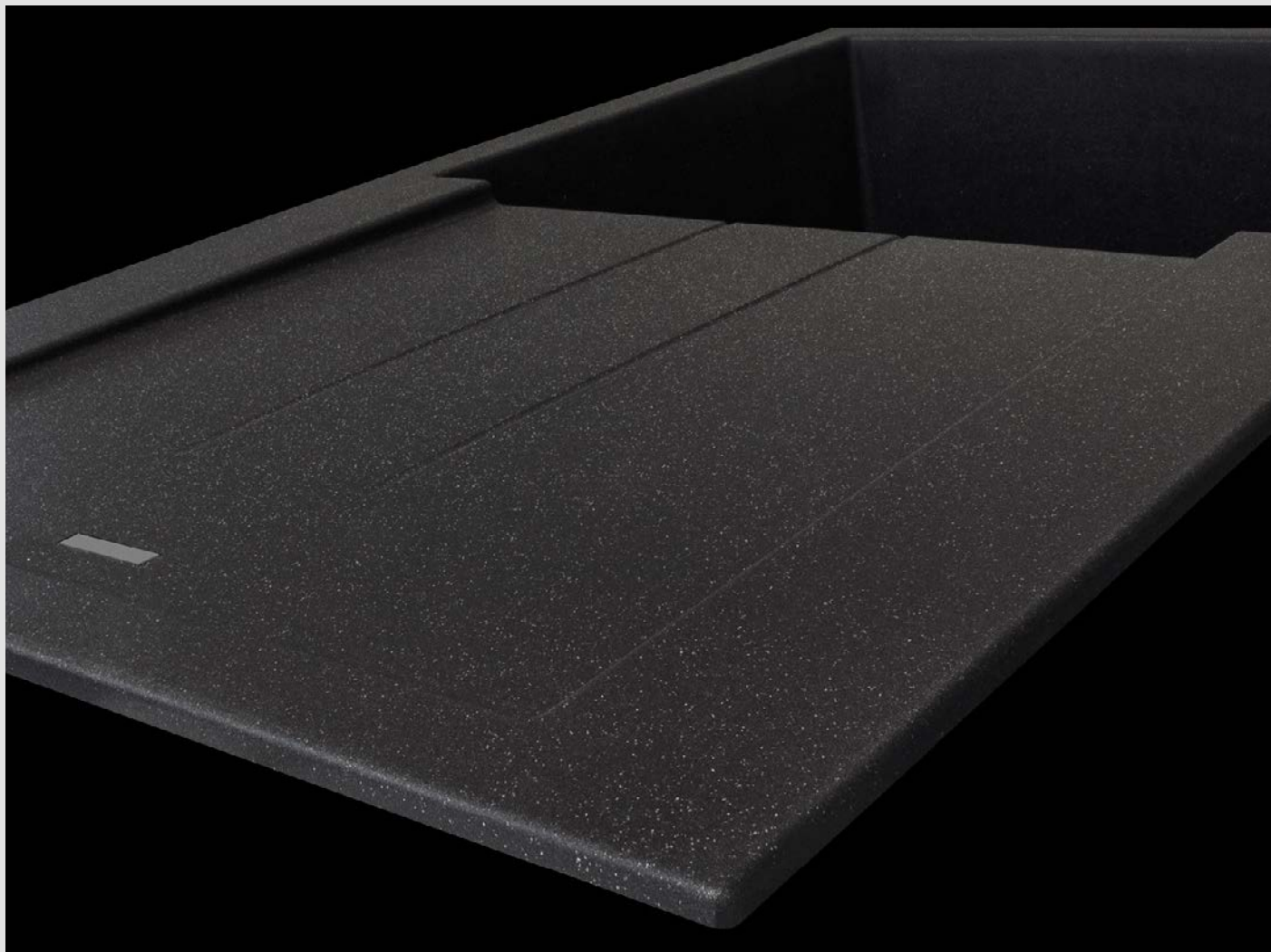

L'altissima concentrazione superficiale (oltre l'80%) di microparticelle di quarzi e graniti generata da un sofisticato processo di sedimentazione in fase di produzione, conferisce al microULTRAGRANIT **straordinarie caratteristiche estetiche ed un piacevole effetto al tatto**, associati ad una elevatissima **durezza superficiale, resistenza** agli agenti chimici, al calore, al graffio.





# LAVELLI



<b>SELEZIONE RINNOVA</b>	42
<b>CONTEMPO</b>	54
<b>LUX</b>	60
<b>COSMO</b>	68
<b>ONE</b> Installazione standard	74
<b>ONE</b> Installazione sotto-top	84
<b>ONE</b> Installazione integrata	94
<b>ELEGANCE</b>	100
<b>INFINITY</b>	108
<b>CORAX</b>	114
<b>ATLANTIC</b>	122
<b>SPAZIO</b>	130
<b>HARMONY</b>	138



IL  
**LAVELLO  
GREEN**  
ALL'ORIGINE

**RINNOVA**

A NEW LEAF

# L'ECONOMIA CIRCOLARE GENERA NUOVO VALORE



## TRASFORMARE GLI SCARTI IN RISORSE DA RE-IMMETTERE NEL PROCESSO PRODUTTIVO

L'economia circolare è un modello di produzione che si basa sul riutilizzo e il riciclo di materie prime esistenti per generare nuovo valore, contribuendo così sia a ridurre i rifiuti sia ad allungare il ciclo di vita del prodotto. Il livello *rinova* ricalca il modello circolare *riciclare-produrre-utilizzare* a partire da materia prima di recupero pari a più del 90%. Essere *green all'origine* significa trasformare qualcosa che è già disponibile in risorsa, dando valore agli scarti esterni ed interni di produzione e non andando ad intaccare le risorse naturali non rinnovabili.

# COME NASCE UN LAVELLO "RINNOVA"

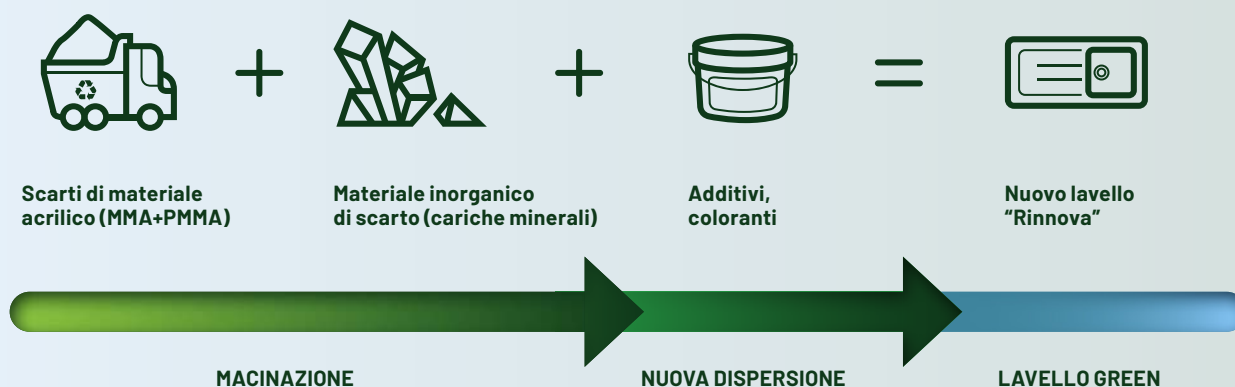

## MATERIE PRIME RINNOVATE AL POSTO DI MATERIE PRIME VERGINI

Il nostro obiettivo era massimizzare l'impiego di materie prime organiche (mma+pmma) e inorganiche (cariche minerali) altrimenti destinate alla discarica, così da non ricorrere a materie prime vergini non rinnovabili. Attraverso un processo di rigenerazione delle materie prime di recupero, abbiamo ottenuto un composto green all'origine che garantisce le stesse caratteristiche chimiche, fisiche, meccaniche ed estetiche rispetto al composto tradizionale dei lavelli Plados. La qualità del prodotto finale è identica, la differenza la fa l'origine della materia prima, una differenza capace di essere valore aggiunto.

# LE PRESTAZIONI NON CAMBIANO



## IL GREEN COME VANTAGGIO QUALITATIVO

La grande sfida del modello sostenibile è riuscire a produrre beni che abbiano un immediato beneficio per l'ambiente senza dover rinunciare agli standard elevati dei requisiti funzionali. Nei lavelli "RINNOVA" l'approccio sostenibile è parte integrante della loro progettazione, delle loro prestazioni e non prescinde mai dalla qualità del prodotto ma è un vantaggio qualitativo: essere green all'origine. I lavelli RINNOVA sono composti da più del 90% di componenti rinnovabili.

# CT9010 / CONTEMPO

NEW

Lavello a una vasca  
VARIE MISURE - Base da 90 cm

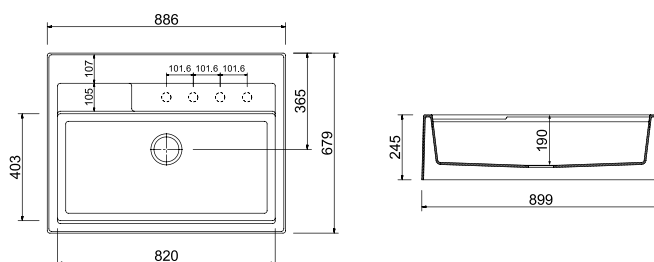

Foro per l'incasso: vedi tabella.

ACCESSORI: 1, 2, 3

RINNOVA

NEW

€ IVA  
esclusa

-  RN R1  
ARCTIC WHITE  
CT9010/... / R1
-  RN R2  
DUNE BEIGE  
CT9010/... / R2
-  RN R3  
ALP STONE  
CT9010/... / R3
-  RN R4  
VOLCANO BLACK  
CT9010/... / R4

1.150

ACCESSORI IN DOTAZIONE:



• Piletta nera con cover e troppopieno neri sulla versione Volcano Black (Cod. KITBLACK1).

• Piletta standard e cover inox sulle altre colorazioni (Cod. COVERIX).

Per la composizione del codice  
fare riferimento alla tabella  
nella pagina successiva.

## ACCESSORI CONSIGLIATI



1\_COPHPLX1



2\_MULTIRACK



3\_VAS700N



## TAGLIO DEL BORDO POSTERIORE E DELL'ALTEZZA

Il bordo posteriore del lavello CONTEMPO è sempre battente a muro ed è stato progettato per essere tagliato in modo da adattarsi a piani di lavoro di profondità differenti e per ottenere una sporgenza pari o superiore a 15 mm rispetto al bordo del top. Allo stesso modo sono stati previsti due tagli in altezza, per fare in modo che il sormonto rispetto al piano di lavoro sia pari o superiore a 15 mm nei top spessi da 12 a 20 mm oppure pari o superiore a 5 mm nei top spessi da 30 a 40 mm.

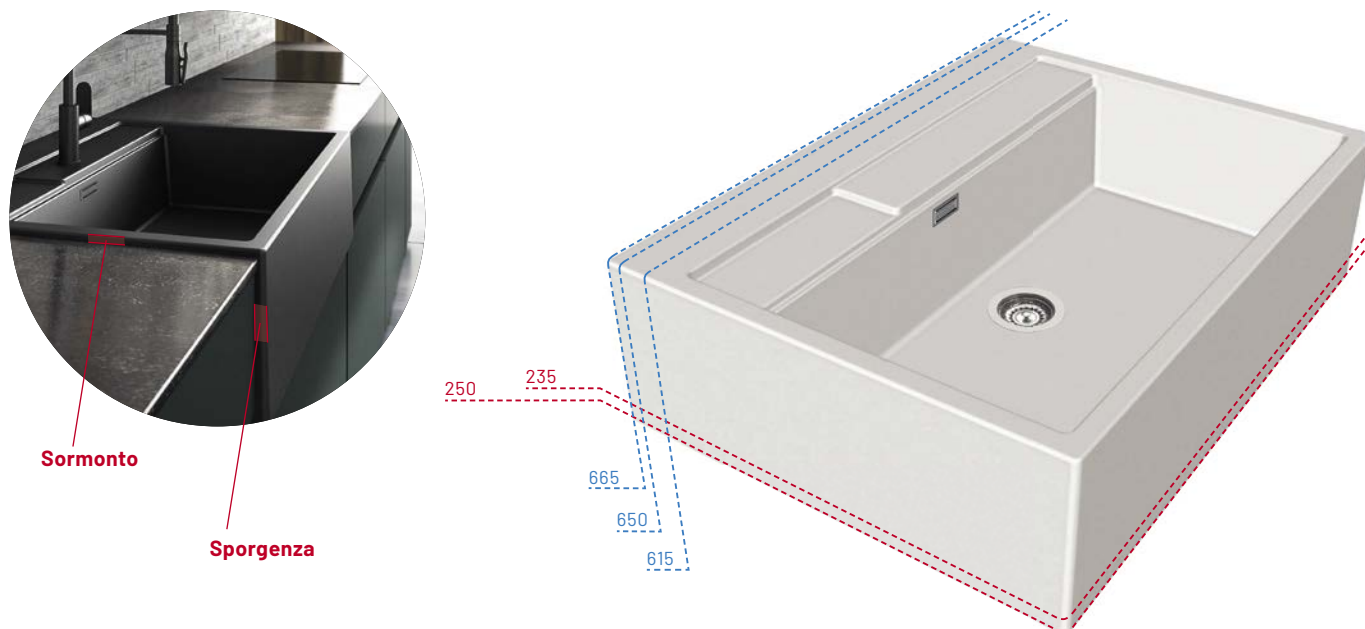

Per ordinare il lavello contempo bisogna indicare **codice prodotto + codice taglio + codice colore**. Scegliere il taglio più adatto, in base alla profondità e allo spessore del piano di lavoro, facendo riferimento ai codici riportati nella seguente tabella; aggiungere infine il codice del colore scelto nella pagina precedente.

	PER TOP PROFONDI 650 mm	PER TOP PROFONDI da 615 mm a 635 mm	PER TOP PROFONDI 600 mm
<b>SPESSORE TOP da 12 mm a 20 mm</b>	Codice: <b>CT9010/23A/...</b> 	Codice: <b>CT9010/23B/...</b> 	Codice: <b>CT9010/23C/...</b> 
	<b>SPESSORE TOP da 30 mm a 40 mm</b>	Codice: <b>CT9010/25A/...</b> 	Codice: <b>CT9010/25B/...</b> 

# LX8610 / LUX



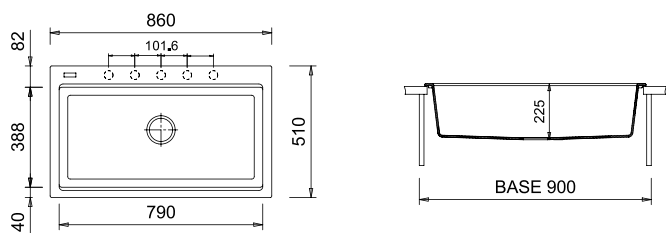

Lavello a una vasca  
860x510 mm - Base da 90 cm



Foro per l'incasso: 840x480 mm

**ACCESSORI: 1, 3, 4, 5, 6**

RINNOVA **NEW** € IVA esclusa

-  RN R1  
ARCTIC WHITE  
LX8610 / R1
  -  RN R2  
DUNE BEIGE  
LX8610 / R2
  -  RN R3  
ALP STONE  
LX8610 / R3
  -  RN R4  
VOLCANO BLACK  
LX8610 / R4
- 670**

INSTALLAZIONE  
SOTTO-TOP

# LX8610ST / LUX



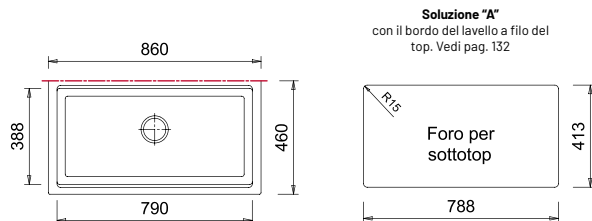

Lavello a una vasca  
860x460 mm - Base da 90 cm



Foro per l'incasso: 788x416 mm

**ACCESSORI: 1, 3, 4, 5, 6**

RINNOVA **NEW** € IVA esclusa

-  RN R1  
ARCTIC WHITE  
LX8610ST / R1
  -  RN R2  
DUNE BEIGE  
LX8610ST / R2
  -  RN R3  
ALP STONE  
LX8610ST / R3
  -  RN R4  
VOLCANO BLACK  
LX8610ST / R4
- 700**

## ACCESSORI CONSIGLIATI



1\_COPHPLX2



2\_TAGCRLUX



3\_LXVASINX



4\_VAS70LX



5\_SPCEINX

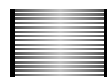

6\_ROLLMAT

# LX8620 / LUX

Lavello a due vasche  
860x510 mm - Base da 90 cm

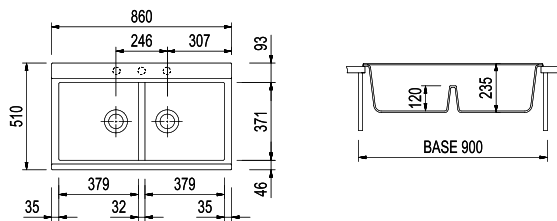

Foro per l'incasso: 840x490 mm

**ACCESSORI: 1, 2, 3, 4, 5, 6**

RINNOVA

NEW

€ IVA  
esclusa

-  RN R1  
ARCTIC WHITE  
LX8620 / R1
-  RN R2  
DUNE BEIGE  
LX8620 / R2
-  RN R3  
ALP STONE  
LX8620 / R3
-  RN R4  
VOLCANO BLACK  
LX8620 / R4

**720**

## ACCESSORI IN DOTAZIONE:



- Piletta nera con cover e troppopieno neri sulla versione Volcano Black (Cod. KITBLACK1 - KITBLACK2).
- Piletta standard e cover inox sulle altre colorazioni (Cod. COVERIX).

# C07510 / COSMO

Lavello a una vasca  
756x456 mm - Base da 80 cm

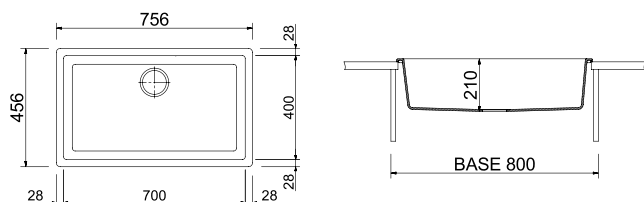

Foro per l'incasso: 745x445 mm



Foro per l'incasso: 700x400 mm

ACCESSORI: 1, 2, 3, 4, 5, 6

RINNOVA

€ IVA esclusa

- RN R1 ARCTIC WHITE  
C07510 / R1
- RN R2 DUNE BEIGE  
C07510 / R2
- RN R3 ALP STONE  
C07510 / R3
- RN R4 VOLCANO BLACK  
C07510 / R4

660

DISPONIBILE DAL 2025

# C05510 / COSMO

Lavello a una vasca  
556x456 mm - Base da 60 cm

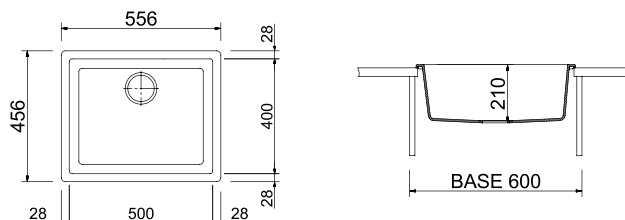

Foro per l'incasso: 545x445 mm



Foro per l'incasso: 500x400 mm

ACCESSORI: 1, 2, 3, 4, 5, 6

RINNOVA

€ IVA esclusa

- RN R1 ARCTIC WHITE  
C05510 / R1
- RN R2 DUNE BEIGE  
C05510 / R2
- RN R3 ALP STONE  
C05510 / R3
- RN R4 VOLCANO BLACK  
C05510 / R4

600

DISPONIBILE DAL 2025

## ACCESSORI CONSIGLIATI



1\_COPHPLON



2\_TAGL44



3\_ONTAGCR



4\_SPCESINX



5\_ROLLUP



6\_ROLLMAT

# C04510 / COSMO

Lavello a una vasca  
456x456 mm - Base da 45/50 cm

NEW

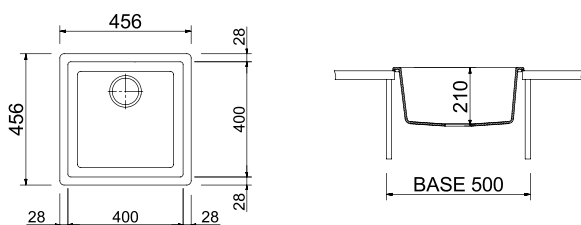

INSTALLAZIONE  
STANDARD

Foro per l'incasso: 445x445 mm



INSTALLAZIONE  
SOTTO-TOP

Foro per l'incasso: 400x400 mm

ACCESSORI: 1, 2, 3, 4, 5, 6

RINNOVA

NEW

€ IVA  
esclusa

-  RN R1  
ARCTIC WHITE  
C04510 / R1
-  RN R2  
DUNE BEIGE  
C04510 / R2
-  RN R3  
ALP STONE  
C04510 / R3
-  RN R4  
VOLCANO BLACK  
C04510 / R4

540

DISPONIBILE DAL 2025

## ACCESSORI IN DOTAZIONE:



- Piletta nera con cover e troppopieno neri sulla versione Volcano Black (Cod. KITBLACK1).
- Piletta standard e cover inox sulle altre colorazioni (Cod. COVERIX).

Nei lavelli COSMO è inclusa sia la ferramenta per l'installazione standard che quella per il montaggio sotto top.

## NF11620 / INFINITY

Lavello a due vasche più scolapiatti - Reversibile  
1160x500 mm - Base da 80 cm

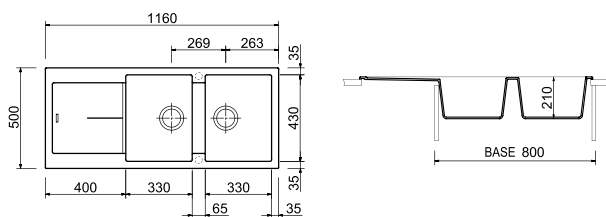
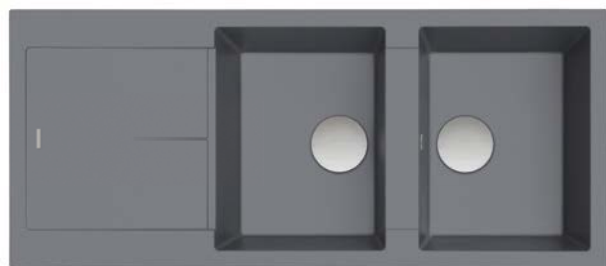

Foro per l'incasso: 1140x480 mm

**ACCESSORI: 1, 2, 3, 4, 5, 6**

**RINNOVA**  € IVA esclusa

-  RN R1 ARCTIC WHITE  
NF11620 / R1
-  RN R2 DUNE BEIGE  
NF11620 / R2
-  RN R3 ALP STONE  
NF11620 / R3
-  RN R4 VOLCANO BLACK  
NF11620 / R4

**640**

## NF9910 / INFINITY

Lavello a una vasca più scolapiatti - Reversibile  
990x500 mm - Base da 60 cm

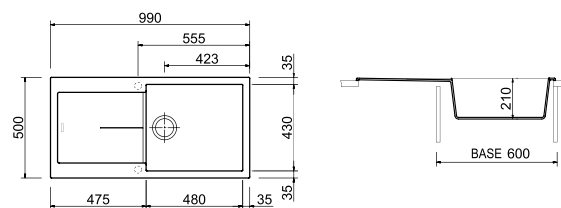

Foro per l'incasso: 970x480 mm

**ACCESSORI: 1, 2, 3, 4, 5, 6**

**RINNOVA**  € IVA esclusa

-  RN R1 ARCTIC WHITE  
NF9910 / R1
-  RN R2 DUNE BEIGE  
NF9910 / R2
-  RN R3 ALP STONE  
NF9910 / R3
-  RN R4 VOLCANO BLACK  
NF9910 / R4

**630**

### ACCESSORI CONSIGLIATI



1\_TAGL88

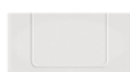

2\_TAGP66



3\_TAGCR



4\_SPCESINX



5\_ROLLUP



6\_ROLLMAT

# NF8610 / INFINITY

Lavello a una vasca più scolapiatti - Reversibile  
860x500 mm - Base da 60 cm

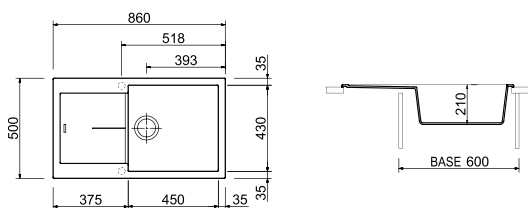

Foro per l'incasso: 840x480 mm

**ACCESSORI: 1, 2, 3, 4, 5, 6**

## ACCESSORI IN DOTAZIONE:



• Piletta nera con cover e troppopieno neri sulla versione Volcano Black (Cod. KITBLACK1 - KITBLACK2).

• Piletta standard e cover inox sulle altre colorazioni (Cod. COVERIX).

RINNOVA



€ IVA esclusa



RN R1  
ARCTIC WHITE  
NF08610 / R1



RN R2  
DUNE BEIGE  
NF08610 / R2



RN R3  
ALP STONE  
NF08610 / R3



RN R4  
VOLCANO BLACK  
NF08610 / R4

**590**





LAVELLI

# CONTEMPO

Un tempo nelle case rurali, il lavabo era il centro di molte operazioni che andavano dalla preparazione dei cibi, al lavaggio di pentole, vestiti e persino bambini. Contempo è la nostra reinterpretazione dell'antico lavabo, con un design rinnovato che attraversando epoche e stili si adatta ad ogni ambientazione, country o moderna. Il banco rubinetteria è ampio e spazioso per ospitare accessori e utensili. Le guide ai bordi della vasca sono progettate per accogliere accessori scorrevoli che rendono l'esperienza d'uso più pratica e funzionale.



ARIAPURA



ITALIAN  
TECHNOLOGY



100% ECO  
COMPATIBILE



#### FINITURE



#### PLUS



ARIA PURA



ITALIAN  
TECHNOLOGY



100% ECO  
COMPATIBILE

#### CORREDO

- Piletta
- Sifone

#### INSTALLAZIONE

- Semi-incasso

# CONTEMPO

## CARATTERISTICHE DI PRODOTTO

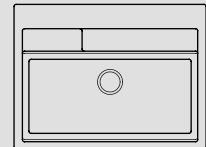

CT9010



### COUNTRY CONTEMPORANEO

Un design senza tempo unisce il fascino del passato alla tecnologia dei più moderni materiali compositi.

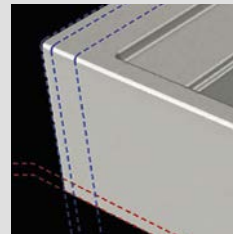

### DIMENSIONI SEMPRE AD HOC

Il lavello è progettato per essere tagliato in modo da adattarsi a diverse esigenze di altezza e profondità.



### ACCESSORI SCORREVOLI

Belli, utili e pratici, gli accessori scorrevoli migliorano l'esperienza d'uso e la vita di ogni giorno.

## MISCELATORI CONSIGLIATI



SHOWERMID  
pag. 192



MIG10  
pag. 198

## REALTÀ AUMENTATA



Inquadra il qr-code con il tuo smartphone per scoprire i nostri lavelli in realtà aumentata.

# CT9010 / CONTEMPO

NEW

Lavello a una vasca  
VARIE MISURE - Base da 90 cm

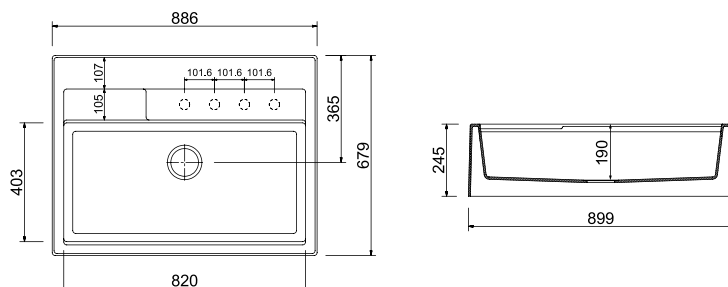

Foro per l'incasso: vedi tabella.

ACCESSORI: 1, 2, 3

NANOSTONE

€ IVA  
esclusa

-  NS N1  
BIANCO LATTE  
CT9010/... / N1
-  NS N3  
ARGAN  
CT9010/... / N3
-  NS N4  
URBAN GREY  
CT9010/... / N4
-  NS N6  
DEEP BLACK  
CT9010/... / N6

1.100

Per la composizione del codice  
fare riferimento alla tabella  
nella pagina successiva.

## ACCESSORI CONSIGLIATI



1\_COPHPLX1



2\_MULTIRACK



3\_VAS700N

## TAGLIO DEL BORDO POSTERIORE E DELL'ALTEZZA

Il bordo posteriore del lavello CONTEMPO è sempre battente a muro ed è stato progettato per essere tagliato in modo da adattarsi a piani di lavoro di profondità differenti e per ottenere una sporgenza pari o superiore a 15 mm rispetto al bordo del top. Allo stesso modo sono stati previsti due tagli in altezza, per fare in modo che il sormonto rispetto al piano di lavoro sia pari o superiore a 15 mm nei top spessi da 12 a 20 mm oppure pari o superiore a 5 mm nei top spessi da 30 a 40 mm.

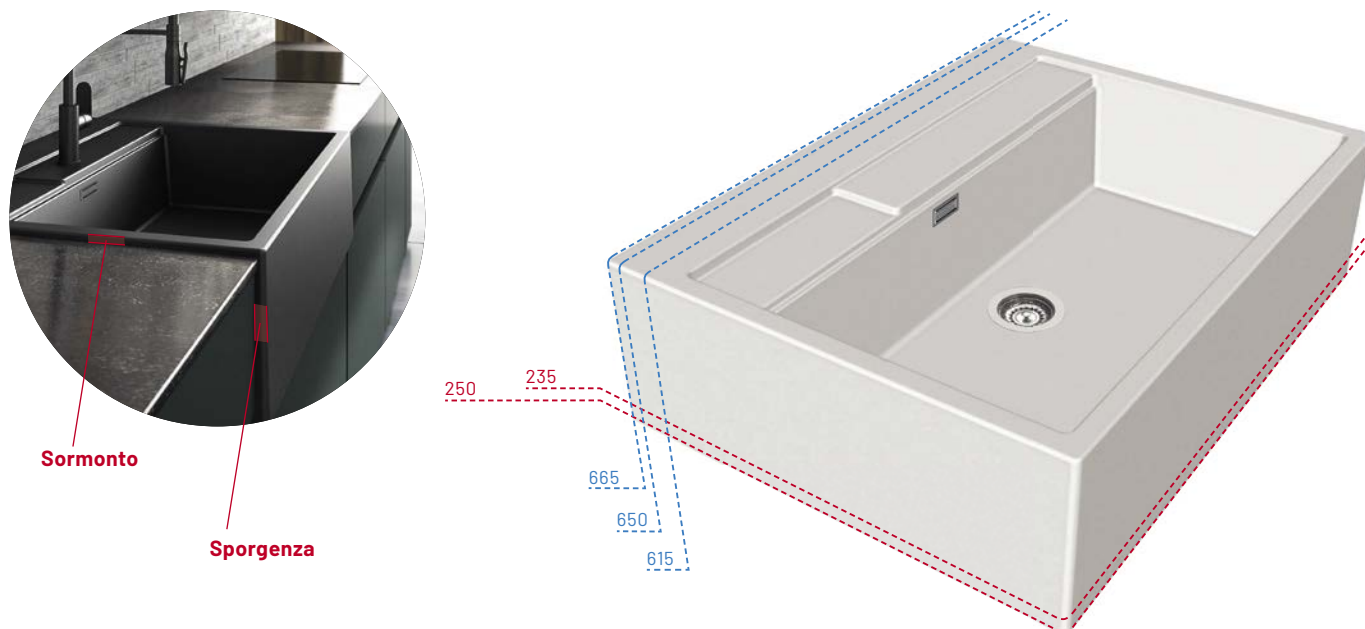

Per ordinare il lavello contempo bisogna indicare **codice prodotto + codice taglio + codice colore**. Scegliere il taglio più adatto, in base alla profondità e allo spessore del piano di lavoro, facendo riferimento ai codici riportati nella seguente tabella; aggiungere infine il codice del colore scelto nella pagina precedente.

	PER TOP PROFONDI 650 mm	PER TOP PROFONDI da 615 mm a 635 mm	PER TOP PROFONDI 600 mm
<b>SPESSORE TOP da 12 mm a 20 mm</b>	Codice: <b>CT9010/23A/...</b> 	Codice: <b>CT9010/23B/...</b> 	Codice: <b>CT9010/23C/...</b> 
	Codice: <b>CT9010/25A/...</b> 	Codice: <b>CT9010/25B/...</b> 	Codice: <b>CT9010/25C/...</b> 
<b>SPESSORE TOP da 30 mm a 40 mm</b>	Codice: <b>CT9010/25A/...</b> 	Codice: <b>CT9010/25B/...</b> 	Codice: <b>CT9010/25C/...</b> 



LAVELLI



# LUX

I modelli della serie LUX sono provvisti di guide su cui posizionare accessori scorrevoli progettati ad hoc: vaschette in acciaio inossidabile, taglieri in cristallo temperato, copri-vasca in HPL e molto altro ancora. Gli accessori di ultima generazione sono disponibili in diverse finiture per potersi abbinare al meglio all'ambiente cucina e rendere il lavello non solo più pratico e funzionale ma anche più elegante.

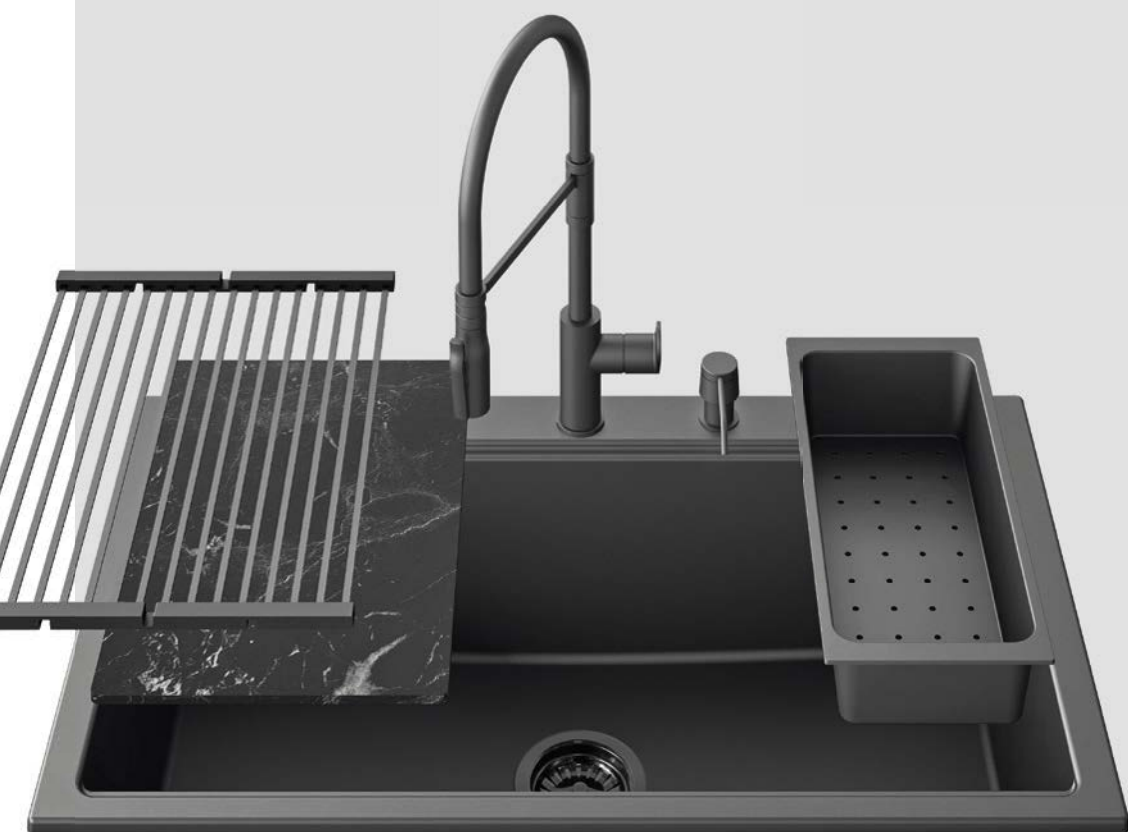

**FINITURE**



**PLUS**



ARIA PURA



ITALIAN TECHNOLOGY



100% ECO COMPATIBILE

**CORREDO**

- Piletta
- Sifone
- Ganci

**INSTALLAZIONE**

- Standard



# LUX

## CARATTERISTICHE DI PRODOTTO

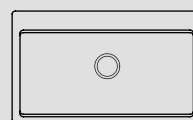

LX8610

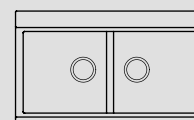

LX8620



### LAVELLI MULTIACCESSORIATI

I modelli della serie LUX sono provvisti di guide su cui posizionare accessori scorrevoli progettati ad hoc, tra cui degli eleganti taglieri in vetro o in HPL ed una comodissima vaschetta in acciaio inox.



### TROPPOPIENO RETTANGOLARE

Nei modelli LX8610, LX8620, è incluso il troppopieno rettangolare di design, con la possibilità di avere numerosi optional come i nuovi copri-piletta o i kit PVD in diverse finiture.



### MAXI VASCHE

Le maxi vasche dei lavelli LUX, praticissime grazie alle grandi dimensioni, sono una soluzione ideale per una cucina spaziosa e per le famiglie numerose.

## MISCELATORI CONSIGLIATI

## REALTÀ AUMENTATA



HEGO  
pag. 192



NEWMIX30  
pag. 198



Inquadra il qr-code con il tuo smartphone per scoprire i nostri lavelli in realtà aumentata.





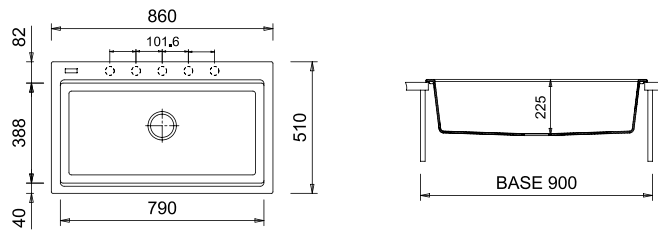





# LX8610 / LUX

Lavello a una vasca  
860x510 mm - Base da 90 cm



Foro per l'incasso: 840x480 mm

**ACCESSORI: 1, 2, 3, 4, 5**

MICROULTRAGRANIT	€ IVA esclusa	NANOSTONE	€ IVA esclusa
<ul style="list-style-type: none"> <li> UG 70 NERO MATT LX8610 / 70</li> <li> UG 72 TARTUFO LX8610 / 72</li> <li> UG 98 BIANCO LX8610 / 98</li> </ul>	<b>500</b>	<ul style="list-style-type: none"> <li> NS N1 BIANCO LATTE LX8610 / N1</li> <li> NS N3 ARGAN LX8610 / N3</li> <li> NS N4 URBAN GREY LX8610 / N4</li> <li> NS N6 DEEP BLACK LX8610 / N6</li> </ul>	<b>620</b>
ULTRAMETAL	€ IVA esclusa		
<ul style="list-style-type: none"> <li> UM 41 ALLUMINIO LX8610 / 41</li> <li> UM 42 TITANIO LX8610 / 42</li> <li> UM 14 CONCRETE LX8610 / 14</li> <li> UM 44 NERO LX8610 / 44</li> </ul>	<b>530</b>		

## ACCESSORI CONSIGLIATI



1\_COPHPLX2    2\_LXVASINX    3\_VAS70LX    4\_SPCESINX    5\_ROLLMAT







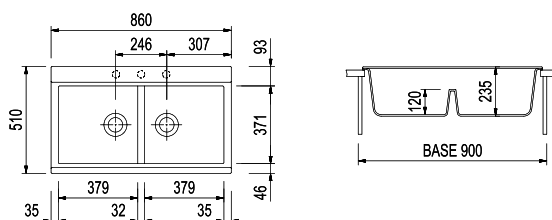





# LX8620 / LUX

Lavello a due vasche  
860x510 mm - Base da 90 cm



Foro per l'incasso: 840x490 mm

## ACCESSORI: 1, 2, 3, 4, 5, 6

MICROULTRAGRANIT	€ IVA esclusa	NANOSTONE	€ IVA esclusa
 UG 70 NERO MATT LX8620 / 70	550	 NS N1 BIANCO LATTE LX8620 / N1	670
 UG 72 TARTUFO LX8620 / 72		 NS N3 ARGAN LX8620 / N3	
 UG 98 BIANCO LX8620 / 98		 NS N4 URBAN GREY LX8620 / N4	
ULTRAMETAL	€ IVA esclusa	 NS N6 DEEP BLACK LX8620 / N6	
 UM 41 ALLUMINIO LX8620 / 41	580		
 UM 42 TITANIO LX8620 / 42			
 UM 14 CONCRETE LX8620 / 14			
 UM 44 NERO LX8620 / 44			

## ACCESSORI CONSIGLIATI

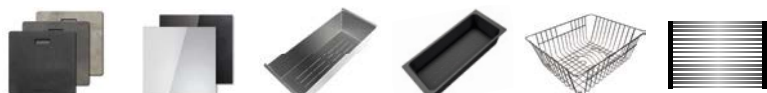

1\_COPHPLX2 2\_TAGCRLUX 3\_LXVASINX 4\_VAS70LX 5\_SPCESINX 6\_ROLLMAT



Coprivasca in HPL - **COPHPLX2**

- COPHPLX2/TOR** - Tortora
- COPHPLX2/CEM** - Cemento
- COPHPLX2/ARD** - Ardesia

Il codice si riferisce a un singolo coprivasca e non alla coppia.



Taglieri in cristallo temperato - **TAGCRLUX**

- Cod. **TAGCRLUX/K1** - Bianco
- Cod. **TAGCRLUX/K2** - Nero

Il codice si riferisce a un singolo tagliere e non alla coppia.



Copri troppopieno  
**TPPE10P**



Copri-piletta di scarico  
**COPPILT10**



Vaschetta in policarbonato  
**VAS70LX**



Vaschetta in acciaio inox  
**LXVASINX**





LAVELLI



# COSMO

Crediamo che la bellezza e la funzionalità siano strettamente legate alla semplicità: Kosmos in greco significa ordine e i lavelli COSMO, con la loro estetica priva di ogni sofisticazione ma al contempo altamente funzionale, incarnano bellezza e semplicità. L'installazione può essere di tipo standard o sotto-top e la ferramenta è inclusa per entrambe.



ARIAPURA



ITALIAN  
TECHNOLOGY



100% ECO  
COMPATIBILE



#### FINITURE



#### PLUS



ARIA PURA



ITALIAN  
TECHNOLOGY



100% ECO  
COMPATIBILE

#### CORREDO

- Piletta
- Sifone

#### INSTALLAZIONE

- Standard
- Sotto-top



# COSMO

## CARATTERISTICHE DI PRODOTTO

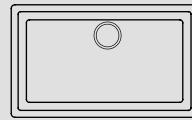

C07510

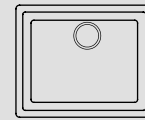

C05510

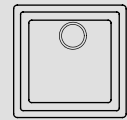

C04510



### ESSENZIALE

Uno stile lineare adatto ad ogni ambiente, dal country al contemporaneo.



### TROPPOPIENO RETTANGOLARE

Nei modelli della serie COSMO il troppopieno rettangolare di design è incluso.

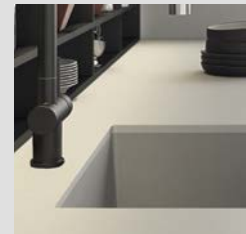

### FERRAMENTA INCLUSA

Nei lavelli della serie COSMO è inclusa sia la ferramenta per l'installazione standard che quella per l'installazione sotto-top.

## MISCELATORI CONSIGLIATI



SPRINGP30  
pag. 194



HYDRA  
pag. 206

## REALTÀ AUMENTATA



Inquadra il qr-code con il tuo smartphone per scoprire i nostri lavelli in realtà aumentata.

# C07510 / COSMO

Lavello a una vasca  
756x456 mm - Base da 80 cm

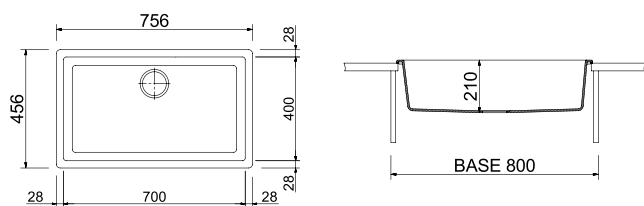

Foro per l'incasso: 745x445 mm



Foro per l'incasso: 700x400 mm

ACCESSORI: 1, 2, 3, 4, 5, 6

## NANOSTONE

€ IVA esclusa



NS N1  
BIANCO LATTE  
C07510 / N1



NS N3  
ARGAN  
C07510 / N3



NS N4  
URBAN GREY  
C07510 / N4



NS N6  
DEEP BLACK  
C07510 / N6

610

DISPONIBILE DAL 2025

# C05510 / COSMO

Lavello a una vasca  
556x456 mm - Base da 60 cm

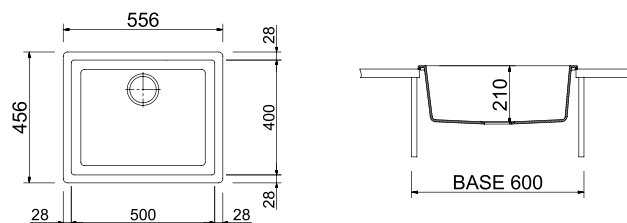

Foro per l'incasso: 545x445 mm



Foro per l'incasso: 500x400 mm

ACCESSORI: 1, 2, 3, 4, 5, 6

## NANOSTONE

€ IVA esclusa



NS N1  
BIANCO LATTE  
C05510 / N1



NS N3  
ARGAN  
C05510 / N3



NS N4  
URBAN GREY  
C05510 / N4



NS N6  
DEEP BLACK  
C05510 / N6

550

DISPONIBILE DAL 2025

### ACCESSORI CONSIGLIATI



1\_C0PHPLON



2\_TAGL44



3\_ONTAGCR



4\_SPCESINX



5\_ROLLUP



6\_ROLLMAT

# C04510 / COSMO

Lavello a una vasca  
456x456 mm - Base da 45/50 cm

NEW

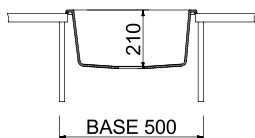
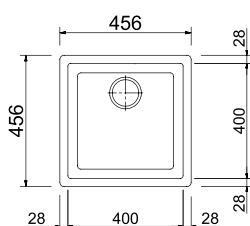

INSTALLAZIONE  
STANDARD

Foro per l'incasso: 445x445 mm



INSTALLAZIONE  
SOTTO-TOP

Foro per l'incasso: 400x400 mm

ACCESSORI: 1, 2, 3, 4, 5, 6

NANOSTONE

€ IVA  
esclusa

NS N1  
BIANCO LATTE  
C04510 / N1

NS N3  
ARGAN  
C04510 / N3

NS N4  
URBAN GREY  
C04510 / N4

NS N6  
DEEP BLACK  
C04510 / N6

490

DISPONIBILE DAL 2025

Nei lavelli COSMO è inclusa sia la ferramenta per l'installazione standard che quella per il montaggio sotto top.

LAVELLI



**ONE**



INSTALLAZIONE  
**STANDARD**

ONE, dal design moderno e funzionale si sposa perfettamente con le cucine minimaliste e di tendenza. La serie ONE è divisa a seconda del metodo di installazione:

- Installazione STANDARD pag. 78-82
- Installazione SOTTO-TOP pag. 88-92
- Installazione INTEGRATA pag. 98







## FINITURE



## PLUS



ARIA PURA



ITALIAN  
TECHNOLOGY



100% ECO  
COMPATIBILE

## CORREDO

- Piletta
- Sifone
- Ganci

## INSTALLAZIONE

- **Standard**
- Sotto-top (pag. 88-92)
- Integrata (pag. 98)

**ONE** - installazione standard  
**CARATTERISTICHE  
 DI PRODOTTO**

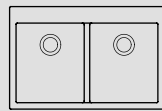

ON8420

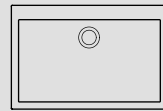

ON8410

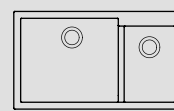

ON8620

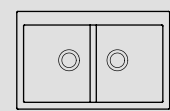

ON7920



ON7610



ON6910

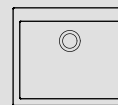

ON6010

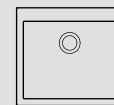

ON5610

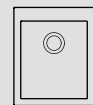

ON4110



**DESIGN  
 MINIMAL**

La serie One, grazie al suo design moderno e funzionale, e ai raggi interni molto stretti, si sposa perfettamente con le cucine minimaliste e di tendenza.



**LAVELLI  
 MULTIACCESSORIATI**

Accessori di ogni tipologia a corredo della serie ONE: taglieri, vaschette in policarbonato, cestelli, copri-piletta creano una vera e propria stazione di lavoro in cucina.

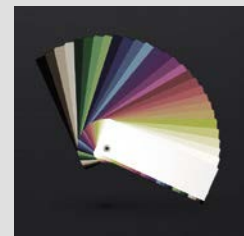

**GAMMA  
 COLORI**

La linea ONE è disponibile in tutti i colori ed in tutte e 3 le nostre finiture.

**MISCELATORI CONSIGLIATI**



NEMO  
 pag. 202



COLONNA  
 pag. 204

**REALTÀ AUMENTATA**



Inquadra il qr-code con il tuo smartphone per scoprire i nostri lavelli in realtà aumentata.



# ON8420 / ONE

Lavello a due vasche  
840x559 mm - Base da 90 cm

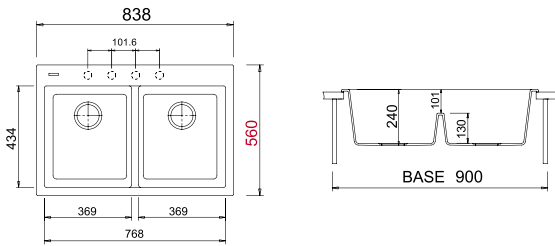

Foro per l'incasso: 820x540 mm  
**ATTENZIONE: Lavello profondo 56 cm**

**ACCESSORI: 7**

### MICROULTRAGRANIT

€ IVA esclusa

- UG 70 NERO MATT ON8420 / 70
- UG 72 TARTUFO ON8420 / 72
- UG 98 BIANCO ON8420 / 98

**580**

### ULTRAMETAL

€ IVA esclusa

- UM 41 ALLUMINIO ON8420 / 41
- UM 42 TITANIO ON8420 / 42
- UM 44 NERO ON8420 / 44

**610**



# ON8410 / ONE

Lavello a una vasca  
840x559 mm - Base da 90 cm

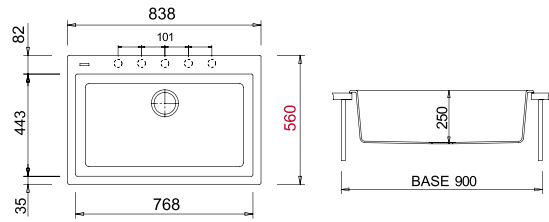

Foro per l'incasso: 820x540 mm  
**ATTENZIONE: Lavello profondo 56 cm**

**ACCESSORI: 7, 12**

### MICROULTRAGRANIT

€ IVA esclusa

- UG 70 NERO MATT ON8410 / 70
- UG 72 TARTUFO ON8410 / 72
- UG 98 BIANCO ON8410 / 98

**540**

### ULTRAMETAL

€ IVA esclusa

- UM 41 ALLUMINIO ON8410 / 41
- UM 42 TITANIO ON8410 / 42
- UM 44 NERO ON8410 / 44

**570**

### ACCESSORI CONSIGLIATI



1\_COPHLON



2\_TAGL44



3\_TAGL88



4\_TAGP66



5\_TAGCR



6\_ONTAGCR



7\_SPCESINX





# ON8620 / ONE

Lavello a due vasche  
860x500 mm - Base da 90 cm

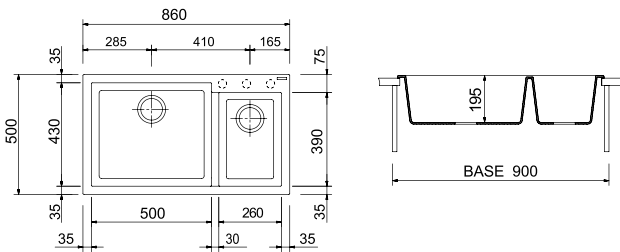

Foro per l'incasso: 840x480 mm

ACCESSORI: 3, 4, 5, 7, 8, 9

### MICROULTRAGRANIT

€ IVA esclusa

- UG 56 JASMINE ON8620 / 56
- UG 70 NERO MATT ON8620 / 70
- UG 72 TARTUFO ON8620 / 72
- UG 90 BIANCO OPALE ON8620 / 90
- UG 94 AVENA ON8620 / 94
- UG 95 NERO EBONY ON8620 / 95
- UG 98 BIANCO ON8620 / 98

530

### ULTRAMETAL

€ IVA esclusa

- UM 41 ALLUMINIO ON8620 / 41
- UM 42 TITANIO ON8620 / 42
- UM 14 CONCRETE ON8620 / 14
- UM 44 NERO ON8620 / 44

560

### NANOSTONE

€ IVA esclusa

- NS N1 BIANCO LATTE ON8620 / N1
- NS N3 ARGAN ON8620 / N3
- NS N4 URBAN GREY ON8620 / N4
- NS N6 DEEP BLACK ON8620 / N6

650



# ON7920 / ONE

Lavello a due vasche  
790x500 mm - Base da 80 cm

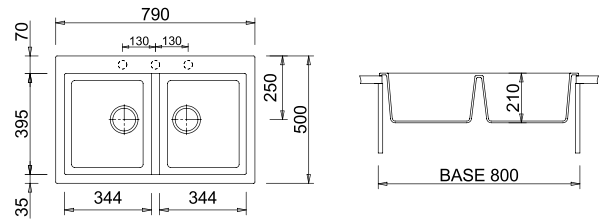

Foro per l'incasso: 770x480 mm

ACCESSORI: 1, 2, 3, 4, 6, 7, 8, 9, 10, 11

### MICROULTRAGRANIT

€ IVA esclusa

- UG 56 JASMINE ON7920 / 56
- UG 70 NERO MATT ON7920 / 70
- UG 72 TARTUFO ON7920 / 72
- UG 90 BIANCO OPALE ON7920 / 90
- UG 94 AVENA ON7920 / 94
- UG 95 NERO EBONY ON7920 / 95
- UG 98 BIANCO ON7920 / 98

505

### ULTRAMETAL

€ IVA esclusa

- UM 41 ALLUMINIO ON7920 / 41
- UM 42 TITANIO ON7920 / 42
- UM 14 CONCRETE ON7920 / 14
- UM 44 NERO ON7920 / 44

535

### NANOSTONE

€ IVA esclusa

- NS N1 BIANCO LATTE ON7920 / N1
- NS N3 ARGAN ON7920 / N3
- NS N4 URBAN GREY ON7920 / N4
- NS N6 DEEP BLACK ON7920 / N6

625



8\_ROLLUP

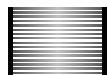

9\_ROLLMAT



10\_ONVASINX



11\_ONVASINX

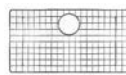

12\_GRID84

# ON7610 / ONE

Lavello a una vasca  
760x500 mm - Base da 80 cm

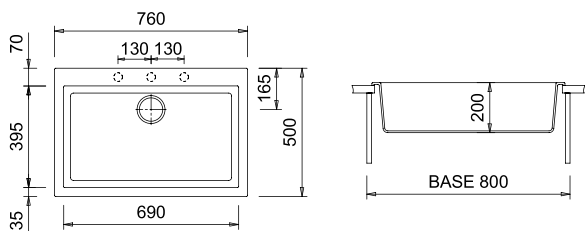

Foro per l'incasso: 740x480 mm

ACCESSORI: 1, 2, 3, 4, 5, 6, 7, 8, 9, 10, 11

# ON6910 / ONE

Lavello a una vasca  
690x500 mm - Base da 75 cm

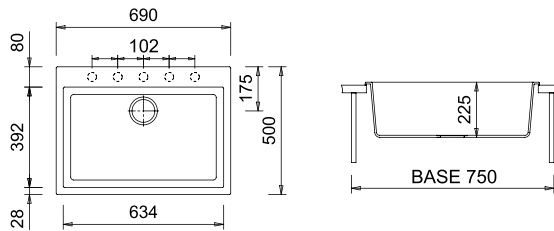

Foro per l'incasso: 680x490 mm

ACCESSORI: 1, 2, 3, 4, 5, 6, 7, 8, 9, 10

## MICROULTRAGRANIT

€ IVA  
esclusa

UG 56  
JASMINE  
ON7610 / 56

UG 70  
NERO MATT  
ON7610 / 70

UG 72  
TARTUFO  
ON7610 / 72

UG 90  
BIANCO OPALE  
ON7610 / 90

450

UG 94  
AVENA  
ON7610 / 94

UG 95  
NERO EBONY  
ON7610 / 95

UG 98  
BIANCO  
ON7610 / 98

## ULTRAMETAL

€ IVA  
esclusa

UM 41  
ALLUMINIO  
ON7610 / 41

UM 42  
TITANIO  
ON7610 / 42

UM 14  
CONCRETE  
ON7610 / 14

UM 44  
NERO  
ON7610 / 44

480

## NANOSTONE

€ IVA  
esclusa

NS N1  
BIANCO LATTE  
ON7610 / N1

NS N3  
ARGAN  
ON7610 / N3

NS N4  
URBAN GREY  
ON7610 / N4

NS N6  
DEEP BLACK  
ON7610 / N6

570

## MICROULTRAGRANIT

€ IVA  
esclusa

UG 56  
JASMINE  
ON6910 / 56

UG 70  
NERO MATT  
ON6910 / 70

UG 72  
TARTUFO  
ON6910 / 72

UG 90  
BIANCO OPALE  
ON6910 / 90

440

UG 94  
AVENA  
ON6910 / 94

UG 95  
NERO EBONY  
ON6910 / 95

UG 98  
BIANCO  
ON6910 / 98

## ULTRAMETAL

€ IVA  
esclusa

UM 41  
ALLUMINIO  
ON6910 / 41

UM 42  
TITANIO  
ON6910 / 42

UM 14  
CONCRETE  
ON6910 / 14

UM 44  
NERO  
ON6910 / 44

470

## NANOSTONE

€ IVA  
esclusa

NS N1  
BIANCO LATTE  
ON6910 / N1

NS N3  
ARGAN  
ON6910 / N3

NS N4  
URBAN GREY  
ON6910 / N4

NS N6  
DEEP BLACK  
ON6910 / N6

560

## ACCESSORI CONSIGLIATI



1\_COPHLON



2\_TAGL44



3\_TAGL88



4\_TAGP66



5\_ONTAGCR



6\_SPCESINX



7\_ROLLUP



8\_ROLLMAT



# ON6010 / ONE

Lavello a una vasca  
600x510 mm - Base da 60-80 cm

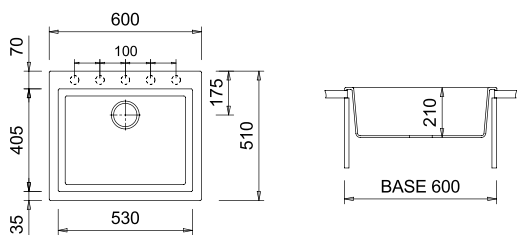

Foro per l'incasso: 580x480 mm

ACCESSORI: 1, 2, 3, 4, 5, 6, 7, 8, 9, 10, 12

### MICROULTRAGRANIT





€ IVA esclusa

-  UG 56 JASMINE  
ON6010 / 56
-  UG 70 NERO MATT  
ON6010 / 70
-  UG 72 TARTUFO  
ON6010 / 72
-  UG 90 BIANCO OPALE  
ON6010 / 90
-  UG 94 AVENA  
ON6010 / 94
-  UG 95 NERO EBONY  
ON6010 / 95
-  UG 98 BIANCO  
ON6010 / 98

420

### ULTRAMETAL

€ IVA esclusa

-  UM 41 ALLUMINIO  
ON6010 / 41
-  UM 42 TITANIO  
ON6010 / 42
-  UM 14 CONCRETE  
ON6010 / 14
-  UM 44 NERO  
ON6010 / 44

450

### NANOSTONE

€ IVA esclusa

-  NS N1 BIANCO LATTE  
ON6010 / N1
-  NS N3 ARGAN  
ON6010 / N3
-  NS N4 URBAN GREY  
ON6010 / N4
-  NS N6 DEEP BLACK  
ON6010 / N6

540



# ON5610 / ONE

Lavello a una vasca  
560x500 mm - Base da 60 cm

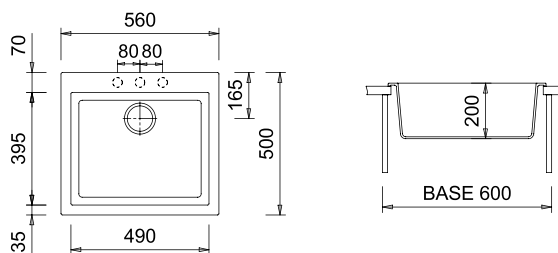







Foro per l'incasso: 540x480 mm

ACCESSORI: 1, 2, 3, 4, 5, 6, 7, 8, 9, 10, 12

### MICROULTRAGRANIT



€ IVA esclusa

-  UG 56 JASMINE  
ON5610 / 56
-  UG 70 NERO MATT  
ON5610 / 70
-  UG 72 TARTUFO  
ON5610 / 72
-  UG 90 BIANCO OPALE  
ON5610 / 90
-  UG 94 AVENA  
ON5610 / 94
-  UG 95 NERO EBONY  
ON5610 / 95
-  UG 98 BIANCO  
ON5610 / 98

420

### ULTRAMETAL



€ IVA esclusa

-  UM 41 ALLUMINIO  
ON5610 / 41
-  UM 42 TITANIO  
ON5610 / 42
-  UM 14 CONCRETE  
ON5610 / 14
-  UM 44 NERO  
ON5610 / 44

450

### NANOSTONE

€ IVA esclusa

-  NS N1 BIANCO LATTE  
ON5610 / N1
-  NS N3 ARGAN  
ON5610 / N3
-  NS N4 URBAN GREY  
ON5610 / N4
-  NS N6 DEEP BLACK  
ON5610 / N6

540



9\_ONVASINX



10\_ONVASINX

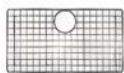

11\_GRID76



12\_GRID60

# ON4110 / ONE

Lavello a una vasca  
410x500 mm - Base da 45 cm

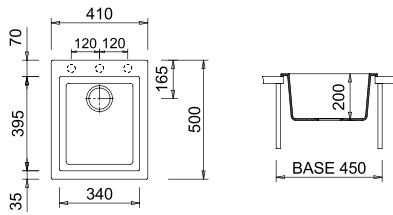

Foro per l'incasso: 390x480 mm

**ACCESSORI: 1, 2, 3, 4, 5, 6, 7, 8**

## MICROULTRAGRANIT

€ IVA  
esclusa

UG 56  
JASMINE  
**ON4110 / 56**

UG 70  
NERO MATT  
**ON4110 / 70**

UG 72  
TARTUFO  
**ON4110 / 72**

UG 90  
BIANCO OPALE  
**ON4110 / 90**

UG 94  
AVENA  
**ON4110 / 94**

UG 95  
NERO EBONY  
**ON4110 / 95**

UG 98  
BIANCO  
**ON4110 / 98**

**360**

## ULTRAMETAL

€ IVA  
esclusa

UM 41  
ALLUMINIO  
**ON4110 / 41**

UM 42  
TITANIO  
**ON4110 / 42**

UM 14  
CONCRETE  
**ON4110 / 14**

UM 44  
NERO  
**ON4110 / 44**

**390**

## NANOSTONE

€ IVA  
esclusa

NS N1  
BIANCO LATTE  
**ON4110 / N1**

NS N3  
ARGAN  
**ON4110 / N3**

NS N4  
URBAN GREY  
**ON4110 / N4**

NS N6  
DEEP BLACK  
**ON4110 / N6**

**480**

## ACCESSORI CONSIGLIATI



1\_COPHLON



2\_TAGL44



3\_ONTAGCR



4\_SPCESINX



5\_ROLLUP



6\_ROLLMAT



7\_ONVASINX



8\_ONVASINX



LAVELLI



**ONE**



INSTALLAZIONE  
SOTTO-TOP

Nella versione sotto-top il lavello viene rifilato anteriormente e posteriormente così da ridurre la profondità. Per il fissaggio viene fornita di serie l'apposita ferramenta (code GANCIST06).







## FINITURE



## PLUS



ARIA PURA



ITALIAN  
TECHNOLOGY



100% ECO  
COMPATIBILE

## CORREDO

- Piletta
- Sifone
- Ganci

## INSTALLAZIONE

- Standard (pag. 78-82)
- **Sotto-top**
- Integrata (pag. 98)



**ONE** - installazione sotto-top  
**CARATTERISTICHE  
 DI PRODOTTO**

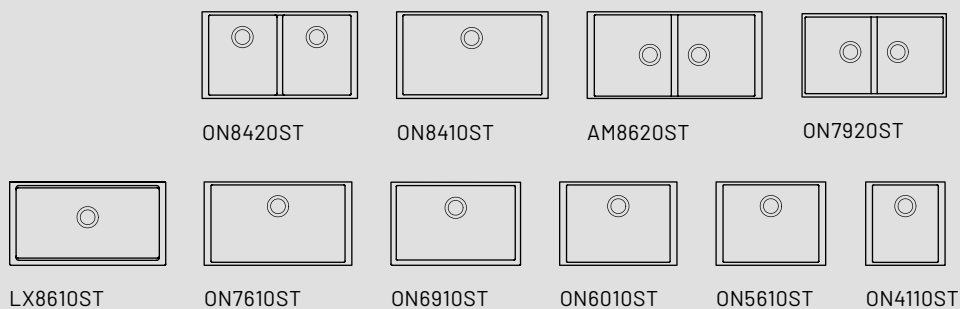

**DESIGN  
 MINIMAL**

La serie One, grazie al suo design moderno e funzionale, e ai raggi interni molto stretti, si sposa perfettamente con le cucine minimaliste e di tendenza.



**LAVELLI  
 MULTIACCESSORIATI**

Accessori di ogni tipologia a corredo della serie ONE: taglieri, vaschette, cestelli, copri-piletta creano una vera e propria stazione di lavoro in cucina.

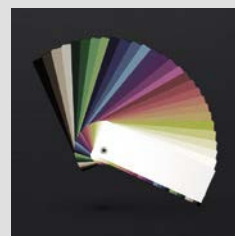

**GAMMA  
 COLORI**

La linea ONE è disponibile in tutti i colori ed in tutte e 3 le nostre finiture.

**MISCELATORI CONSIGLIATI**



NEMO  
 pag. 202



PARMIXEXT  
 pag. 208

**REALTÀ AUMENTATA**



Inquadra il qr-code con il tuo smartphone per scoprire i nostri lavelli in realtà aumentata.

# ON8420ST / ONE

Lavello a due vasche  
838x470 mm - Base da 90 cm

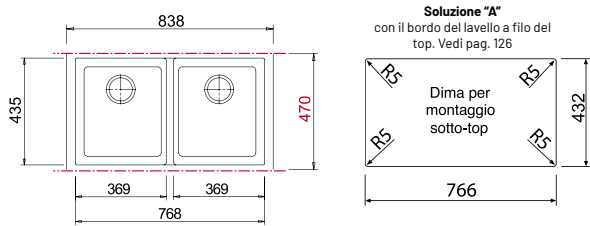

Foro per l'incasso: 766x432 mm  
**ATTENZIONE: Lavello profondo 47 cm**



ACCESSORI: 4, 5

**MICROULTRAGRANIT**



€ IVA esclusa

**ULTRAMETAL**

€ IVA esclusa

-  UG 70  
NERO MATT  
ON8420ST / 70
-  UG 72  
TARTUFO  
ON8420ST / 72
-  UG 98  
BIANCO  
ON8420ST / 98

**610**

-  UM 41  
ALLUMINIO  
ON8420ST / 41
-  UM 42  
TITANIO  
ON8420ST / 42
-  UM 44  
NERO  
ON8420ST / 44

**640**

# ON8410ST / ONE

Lavello a una vasca  
838x510 mm - Base da 90 cm

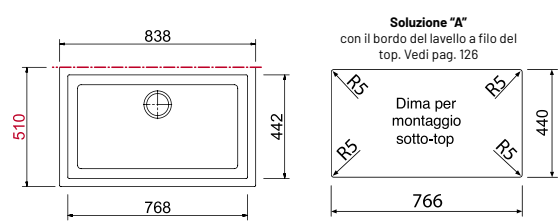

Foro per l'incasso: 765x440 mm  
**ATTENZIONE: Lavello profondo 51 cm**



ACCESSORI: 4, 9

**MICROULTRAGRANIT**

€ IVA esclusa

**ULTRAMETAL**

€ IVA esclusa

-  UG 70  
NERO MATT  
ON8410ST / 70
-  UG 72  
TARTUFO  
ON8410ST / 72
-  UG 98  
BIANCO  
ON8410ST / 98

**570**

-  UM 41  
ALLUMINIO  
ON8410ST / 41
-  UM 42  
TITANIO  
ON8410ST / 42
-  UM 44  
NERO  
ON8410ST / 44

**600**

**ACCESSORI CONSIGLIATI**



1\_COPHPLON



2\_TAGL44



3\_ONTAGCR



4\_SPCESINX



5\_ROLLUP



6\_ROLLMAT



# AM8620ST / ELEGANCE

Lavello a due vasche  
860x435 mm - Base da 90 cm

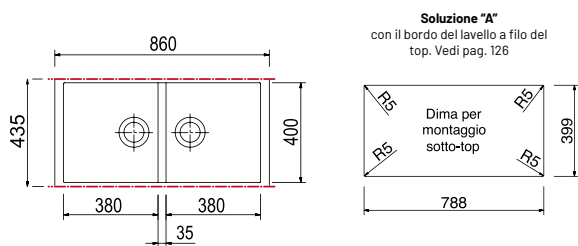

Foro per l'incasso: 788x399 mm

ACCESSORI: 1, 2, 3, 4, 5, 6, 7, 8

### MICROULTRAGRANIT

€ IVA esclusa

- UG 56 JASMINE  
**AM8620ST / 56**
- UG 70 NERO MATT  
**AM8620ST / 70**
- UG 72 TARTUFO  
**AM8620ST / 72**
- UG 90 BIANCO OPALE  
**AM8620ST / 90**
- UG 94 AVENA  
**AM8620ST / 94**
- UG 95 NERO EBONY  
**AM8620ST / 95**
- UG 98 BIANCO  
**AM8620ST / 98**

530

### ULTRAMETAL

€ IVA esclusa

- UM 41 ALLUMINIO  
**AM8620ST / 41**
- UM 42 TITANIO  
**AM8620ST / 42**
- UM 14 CONCRETE  
**AM8620ST / 14**
- UM 44 NERO  
**AM8620ST / 44**

560

### NANOSTONE

€ IVA esclusa

- NS N1 BIANCO LATTE  
**AM8620ST / N1**
- NS N3 ARGAN  
**AM8620ST / N3**
- NS N4 URBAN GREY  
**AM8620ST / N4**
- NS N6 DEEP BLACK  
**AM8620ST / N6**

650



# ON7920ST / ONE

Lavello a due vasche  
755x435 mm - Base da 80 cm

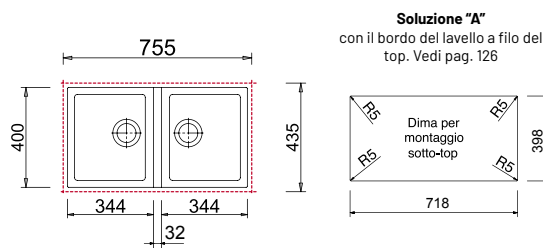

Foro per l'incasso: 718x398 mm

ACCESSORI: 1, 2, 3, 4, 5, 6, 7, 8

### MICROULTRAGRANIT

€ IVA esclusa

- UG 56 JASMINE  
**ON7920ST / 56**
- UG 70 NERO MATT  
**ON7920ST / 70**
- UG 72 TARTUFO  
**ON7920ST / 72**
- UG 90 BIANCO OPALE  
**ON7920ST / 90**
- UG 94 AVENA  
**ON7920ST / 94**
- UG 95 NERO EBONY  
**ON7920ST / 95**
- UG 98 BIANCO  
**ON7920ST / 98**

535

### ULTRAMETAL

€ IVA esclusa

- UM 41 ALLUMINIO  
**ON7920ST / 41**
- UM 42 TITANIO  
**ON7920ST / 42**
- UM 14 CONCRETE  
**ON7920ST / 14**
- UM 44 NERO  
**ON7920ST / 44**

565

### NANOSTONE

€ IVA esclusa

- NS N1 BIANCO LATTE  
**ON7920ST / N1**
- NS N3 ARGAN  
**ON7920ST / N3**
- NS N4 URBAN GREY  
**ON7920ST / N4**
- NS N6 DEEP BLACK  
**ON7920ST / N6**

655



7\_ONVASINX



8\_ONVASINX

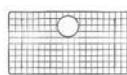

9\_GRID84

# LX8610ST / LUX

Lavello a una vasca  
860x435 mm - Base da 90 cm

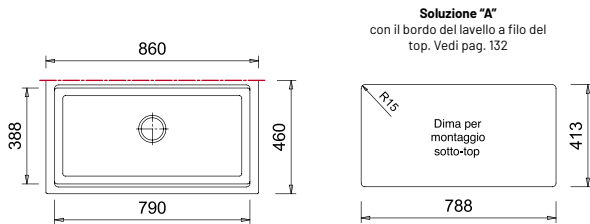



Foro per l'incasso: 788x416 mm

ACCESSORI: 1, 5, 6, 7, 8, 10

## MICROULTRAGRANIT

€ IVA esclusa

-  UG 70  
NERO MATT  
LX8610ST / 70
-  UG 72  
TARTUFO  
LX8610ST / 72
-  UG 98  
BIANCO  
LX8610ST / 98

530

## ULTRAMETAL

€ IVA esclusa

-  UM 41  
ALLUMINIO  
LX8610ST / 41
-  UM 42  
TITANIO  
LX8610ST / 42
-  UM 14  
CONCRETE  
LX8610ST / 14
-  UM 44  
NERO  
LX8610ST / 44

560

## NANOSTONE

€ IVA esclusa

-  NS N1  
BIANCO LATTE  
LX8610ST / N1
-  NS N3  
ARGAN  
LX8610ST / N3
-  NS N4  
URBAN GREY  
LX8610ST / N4
-  NS N6  
DEEP BLACK  
LX8610ST / N6

650

# ON7610ST / ONE

Lavello a una vasca  
760x435 mm - Base da 80 cm

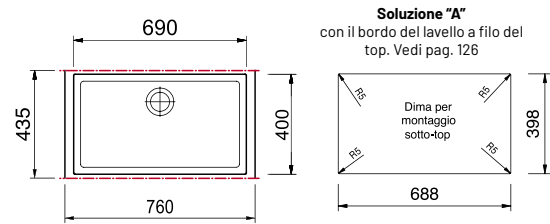







Foro per l'incasso: 688x398 mm

ACCESSORI: 2, 3, 4, 5, 6, 7, 9, 11, 12

## MICROULTRAGRANIT

€ IVA esclusa

-  UG 56  
JASMINE  
ON7610ST / 56
-  UG 70  
NERO MATT  
ON7610ST / 70
-  UG 72  
TARTUFO  
ON7610ST / 72
-  UG 90  
BIANCO OPALE  
ON7610ST / 90
-  UG 94  
AVENA  
ON7610ST / 94
-  UG 95  
NERO EBONY  
ON7610ST / 95
-  UG 98  
BIANCO  
ON7610ST / 98

480

## ULTRAMETAL





€ IVA esclusa

-  UM 41  
ALLUMINIO  
ON7610ST / 41
-  UM 42  
TITANIO  
ON7610ST / 42
-  UM 14  
CONCRETE  
ON7610ST / 14
-  UM 44  
NERO  
ON7610ST / 44

510

## NANOSTONE

€ IVA esclusa

-  NS N1  
BIANCO LATTE  
ON7610ST / N1
-  NS N3  
ARGAN  
ON7610ST / N3
-  NS N4  
URBAN GREY  
ON7610ST / N4
-  NS N6  
DEEP BLACK  
ON7610ST / N6

600

## ACCESSORI CONSIGLIATI



1\_COPHPLX2



2\_COPHPLON



3\_TAGL44



4\_ONTAGCR



5\_SPCESINX



6\_ROLLUP

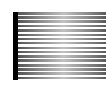

7\_ROLLMAT

# ON6910ST / ONE

Lavello a una vasca  
690x443 mm - Base da 75 cm

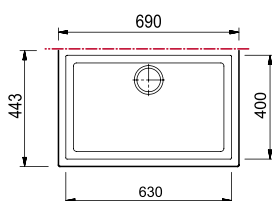

**Soluzione "A"**  
con il bordo del lavello a filo del top. Vedi pag. 126

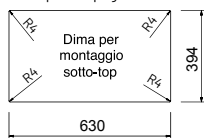







Foro per l'incasso: 630x394 mm

**ACCESSORI: 2, 3, 4, 5, 6, 7, 9, 11**

## MICROULTRAGRANIT

€ IVA esclusa

-  UG 56  
JASMINE  
**ON6910ST / 56**
-  UG 70  
NERO MATT  
**ON6910ST / 70**
-  UG 72  
TARTUFO  
**ON6910ST / 72**
-  UG 90  
BIANCO OPALE  
**ON6910ST / 90**
-  UG 94  
AVENA  
**ON6910ST / 94**
-  UG 95  
NERO EBONY  
**ON6910ST / 95**
-  UG 98  
BIANCO  
**ON6910ST / 98**

470

## ULTRAMETAL

€ IVA esclusa

-  UM 41  
ALLUMINIO  
**ON6910ST / 41**
-  UM 42  
TITANIO  
**ON6910ST / 42**
-  UM 14  
CONCRETE  
**ON6910ST / 14**
-  UM 44  
NERO  
**ON6910ST / 44**

500

## NANOSTONE

€ IVA esclusa

-  NS N1  
BIANCO LATTE  
**ON6910ST / N1**
-  NS N3  
ARGAN  
**ON6910ST / N3**
-  NS N4  
URBAN GREY  
**ON6910ST / N4**
-  NS N6  
DEEP BLACK  
**ON6910ST / N6**

590

# ON6010ST / ONE

Lavello a una vasca  
600x440 mm - Base da 80 cm

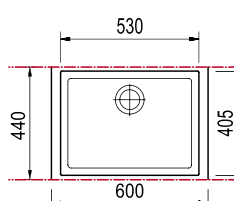

**Soluzione "A"**  
con il bordo del lavello a filo del top. Vedi pag. 126

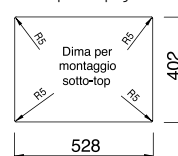

Foro per l'incasso: 528x402 mm

**ACCESSORI: 2, 3, 4, 5, 6, 7, 9, 11**

## MICROULTRAGRANIT

€ IVA esclusa

-  UG 56  
JASMINE  
**ON6010ST / 56**
-  UG 98  
BIANCO  
**ON6010ST / 98**
-  UG 70  
NERO MATT  
**ON6010ST / 70**
-  UG 72  
TARTUFO  
**ON6010ST / 72**
-  UG 90  
BIANCO OPALE  
**ON6010ST / 90**
-  UG 94  
AVENA  
**ON6010ST / 94**
-  UG 95  
NERO EBONY  
**ON6010ST / 95**

450

## ULTRAMETAL





€ IVA esclusa

-  UM 41  
ALLUMINIO  
**ON6010ST / 41**
-  UM 42  
TITANIO  
**ON6010ST / 42**
-  UM 14  
CONCRETE  
**ON6010ST / 14**
-  UM 44  
NERO  
**ON6010ST / 44**

480

## NANOSTONE

€ IVA esclusa

-  NS N1  
BIANCO LATTE  
**ON6010ST / N1**
-  NS N3  
ARGAN  
**ON6010ST / N3**
-  NS N4  
URBAN GREY  
**ON6010ST / N4**
-  NS N6  
DEEP BLACK  
**ON6010ST / N6**

570



8\_LXVASINX



9\_ONVASINX



10\_VAS70LX



11\_ONVASINX

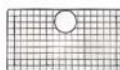

12\_GRID76



13\_GRID60

# ON5610ST / ONE

Lavello a una vasca  
560x435 mm - Base da 60 cm

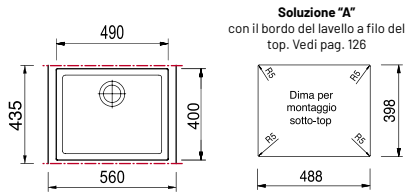

Foro per l'incasso: 488x398 mm

**ACCESSORI: 1, 2, 3, 4, 5, 6, 7, 8, 9**

**MICROULTRAGRANIT**

€ IVA esclusa

-  UG 56 JASMINE  
**ON5610ST / 56**
-  UG 70 NERO MATT  
**ON5610ST / 70**
-  UG 72 TARTUFO  
**ON5610ST / 72**
-  UG 90 BIANCO OPALE  
**ON5610ST / 90**
-  UG 94 AVENA  
**ON5610ST / 94**
-  UG 95 NERO EBONY  
**ON5610ST / 95**
-  UG 98 BIANCO  
**ON5610ST / 98**

**450**

**ULTRAMETAL**



€ IVA esclusa

-  UM 41 ALLUMINIO  
**ON5610ST / 41**
-  UM 42 TITANIO  
**ON5610ST / 42**
-  UM 14 CONCRETE  
**ON5610ST / 14**
-  UM 44 NERO  
**ON5610ST / 44**

**480**

**NANOSTONE**

€ IVA esclusa

-  NS N1 BIANCO LATTE  
**ON5610ST / N1**
-  NS N3 ARGAN  
**ON5610ST / N3**
-  NS N4 URBAN GREY  
**ON5610ST / N4**
-  NS N6 DEEP BLACK  
**ON5610ST / N6**

**570**

# ON4110ST / ONE

Lavello a una vasca  
410x435 mm - Base da 45 cm

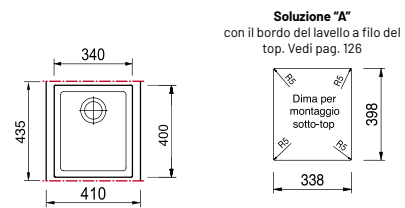







Foro per l'incasso: 338x398 mm

**ACCESSORI: 1, 2, 3, 4, 5, 6, 7, 8**

**MICROULTRAGRANIT**

€ IVA esclusa

-  UG 56 JASMINE  
**ON4110ST / 56**
-  UG 70 NERO MATT  
**ON4110ST / 70**
-  UG 72 TARTUFO  
**ON4110ST / 72**
-  UG 90 BIANCO OPALE  
**ON4110ST / 90**
-  UG 94 AVENA  
**ON4110ST / 94**
-  UG 95 NERO EBONY  
**ON4110ST / 95**
-  UG 98 BIANCO  
**ON4110ST / 98**

**390**

**ULTRAMETAL**

€ IVA esclusa

-  UM 41 ALLUMINIO  
**ON4110ST / 41**
-  UM 42 TITANIO  
**ON4110ST / 42**
-  UM 14 CONCRETE  
**ON4110ST / 14**
-  UM 44 NERO  
**ON4110ST / 44**

**420**

**NANOSTONE**

€ IVA esclusa

-  NS N1 BIANCO LATTE  
**ON4110ST / N1**
-  NS N3 ARGAN  
**ON4110ST / N3**
-  NS N4 URBAN GREY  
**ON4110ST / N4**
-  NS N6 DEEP BLACK  
**ON4110ST / N6**

**510**

**ACCESSORI CONSIGLIATI**



1\_COPHLON



2\_TAGL44



3\_ONTAGCR



4\_SPACESINX



5\_ROLLUP



6\_ROLLMAT



7\_ONVASINX



8\_ONVASINX

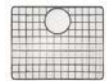

9\_GRID60



LAVELLI



**ONE**



INSTALLAZIONE  
**INTEGRATA**

Nella versione per installazione integrata il perimetro del lavello viene fresato sia lateralmente che superficialmente: questa lavorazione rende il bordo perimetrale perfettamente piatto e quindi idoneo ad essere integrato al top.









## FINITURE



## PLUS



ARIA PURA



ITALIAN  
TECHNOLOGY



100% ECO  
COMPATIBILE

## CORREDO

- Piletta
- Sifone
- Ganci

## INSTALLAZIONE

- Standard (pag. 78-82)
- Sotto-top (pag. 88-92)
- **Integrata**

ATTENZIONE: In caso di richiesta, da parte del consumatore, di sostituzione del lavello per rottura da shock termico, l'azienda provvederà alla sostituzione dello stesso con il medesimo modello, ma nella tradizionale versione da incasso.

# ONE - installazione integrata

## CARATTERISTICHE DI PRODOTTO



ON7610IT

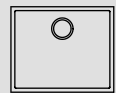

ON5610IT



### COLORI AD HOC

I colori NANOSTONE sono stati studiati per abbinarsi perfettamente ai piani di lavoro.



### LAVELLI MULTIACCESSORIATI

Accessori di ogni tipologia a corredo della serie ONE: taglieri, vaschette, cestelli, copri-piletta creano una vera e propria stazione di lavoro in cucina.

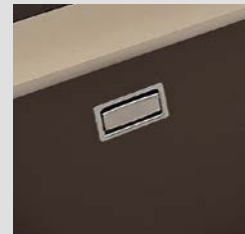

### TROPPOPIENO RETTANGOLARE

La linea ONE per installazione integrata ha l'elegante troppopieno rettangolare di serie.

## MISCELATORI CONSIGLIATI



NEMO  
pag. 202



PUNTOBPEX  
pag. 208

## REALTÀ AUMENTATA



Inquadra il qr-code con il tuo smartphone per scoprire i nostri lavelli in realtà aumentata.

## ON7610IT / ONE



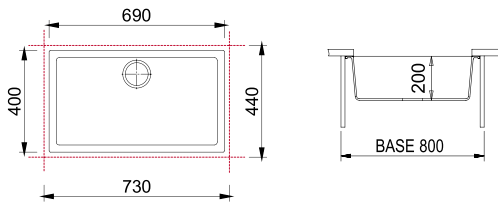

Lavello a una vasca  
730x435 mm - Base da 80 cm



ACCESSORI: 1, 2, 3, 4, 5, 6, 7, 8, 9

### NANOSTONE

€ IVA  
esclusa

	NS N1 BIANCO LATTE <b>ON7610IT / N1</b>	<b>650</b>
	NS N3 ARGAN <b>ON7610IT / N3</b>	
	NS N4 URBAN GREY <b>ON7610IT / N4</b>	
	NS N6 DEEP BLACK <b>ON7610IT / N6</b>	

## ON5610IT / ONE



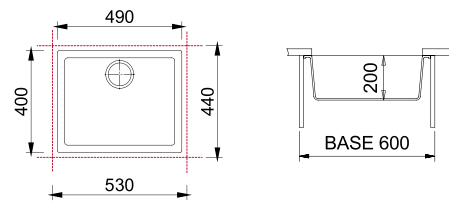

Lavello a una vasca  
530x435 mm - Base da 60 cm



ACCESSORI: 1, 2, 3, 4, 5, 6, 7, 8, 10

### NANOSTONE

€ IVA  
esclusa

	NS N1 BIANCO LATTE <b>ON5610IT / N1</b>	<b>620</b>
	NS N3 ARGAN <b>ON5610IT / N3</b>	
	NS N4 URBAN GREY <b>ON5610IT / N4</b>	
	NS N6 DEEP BLACK <b>ON5610IT / N6</b>	

Il copri-piletta COPPILT10 visibile nelle immagini è un accessorio optional.

### ACCESSORI CONSIGLIATI



1\_COPHPLON



2\_TAGL44



3\_ONTAGCR



4\_SPCESINX



5\_ROLLUP



6\_ROLLMAT



7\_ONVASINX



8\_ONVASINX

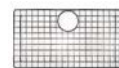

9\_GRID76



10\_GRID60

# TOP & LAVELLO COORDINATI PER INSTALLAZIONE INTEGRATA

Abbinamenti suggeriti dei **colori nanoSTONE** Plados con i colori dei principali produttori di **piani di lavoro**

PRINCIPALI  
PRODUTTORI DI  
PIANI DI LAVORO

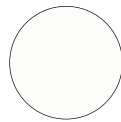

nanoSTONE  
N1 Bianco Latte



nanoSTONE  
N3 Argan

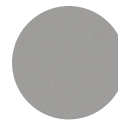

nanoSTONE  
N4 Urban Grey



nanoSTONE  
N6 Deep Black

## PIETRE SINTETIZZATE O GRES CERAMICA

<b>DEKTON</b>	• ZENITH • OPERA • KAIROS	• GALEMA	• KORUS • VENTUS • TRILIUM	• DOMOOS • SIRIUS • KELIA
<b>LAMINAM</b>	• BIANCO ASSOLUTO • ARABESCATO • OPACO fin. CAVA	• TERRA fin. FOKOS	• GRIGIO fin. CALCE	• NERO ASSOLUTO • NERO fin. BLEND • NERO fin. CALCE • OSSIDO NERO
<b>IRIS/ SAPIEN STONE</b>	• UNI ICE • CALACATTA	• SAND EARTH	• URBAN ARGENTO • LIGHT EARTH	• URBAN ANTRACITE • NOIR • MALM BLACK
<b>FLORIM</b>	• COLOR WHITE	• STONE BROWN	• CEMENT LIGHT GREY	• COLOR BLACK • MARBLE MARQUINIA
<b>INFINITY</b>	• ABSOLUTE WHITE • TOTAL WHITE		• TUNDRA SELECT • CONCRETE LIGHT	• TOTAL BLACK MATT • NERO MARQUINIA
<b>LAPITEC</b>	• BIANCO ASSOLUTO	• AVANA • MOCA	• GRIGIO CEMENTO	• NERO ASSOLUTO • EBANO
<b>KERLITE</b>	• MATERICA BIANCO • VANITY • BIANCO LUCE • ULTRA WHITE	• MATERICA TORTORA • ELEGANCE • VIA FARINI	• ELEGANCE • VIA TORNABUONI • OVER OFFICE	• BLACK • MATERICA ARDESIA • OVER ROAD

## AGGLOMERATI IN QUARZO

<b>SILESTONE</b>	• BIANCO ZEUS • MIAMI WHITE • WHITE STORM	• UNSUI • NOKA • ROUGUI	• KENSHO	• NEGRO TEBAS • MARQUINIA
<b>QUARTZFORM</b>	• WHITE	• DESERT	• LIGHT GREY	• BLACK
<b>STONE ITALIANA</b>	• SUPER WHITE • CANDIDO • VIRGO • CRISTAL WHITE	• TERRA • GREIGE • TAUPE	• PITTI • ELEPHANT GREY	• IMPERIALE • MAGMA GREY
<b>OKITE</b>	• BIANCO • CALACATTA	• EASY BRONZE	• GRIGIO ORIENTE • EASY GREY	• NERO ASSOLUTO • MARQUINIA BLACK • CORVINO • PRISMA NERO
<b>SANTAMARGHERITA</b>	• ZENITH • VEGA • EASY WHITE • ALTEA • BIANCO NEVE	• MOSA • ELBA • METROPOLIS COPPER • OREGON	• LINO • GRIGIO PERLA • AMIATA	• NERO • METROPOLIS GALAXY • ARDENNE • IRON
<b>ILEXA</b>	• ABSOLUTE BLANC • JAVA WHITE • BIANCO • GLACIAR • LUNA • ALASKA	• JAVA TAUPE • TORTORA • FOX GREY • DIM GREY	• CENIZA • CEMENTO	• JAVA BLACK • ROYAL BLACK



LAVELLI

# ELEGANCE

Essenziale, lineare, Elegance è un concentrato di stile e modernità e può essere convenientemente installata in qualsiasi tipologia di cucine componibili. Le linee squadrate e il bordo superiore ampio e completamente piatto consentono di utilizzare questi modelli anche per il montaggio sotto-top.





#### FINITURE



#### PLUS



ARIA PURA



ITALIAN  
TECHNOLOGY



100% ECO  
COMPATIBILE

#### CORREDO

- Piletta
- Sifone
- Ganci

#### INSTALLAZIONE

- Standard
- Sotto-top



# ELEGANCE

## CARATTERISTICHE DI PRODOTTO

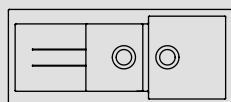

AM11620

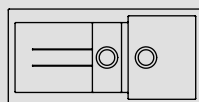

AM9915

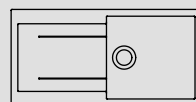

AM9910

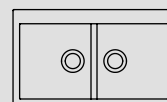

AM8620

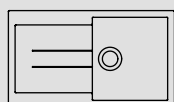

AM8610

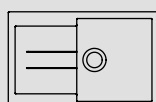

AM7810

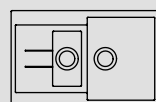

AM7815

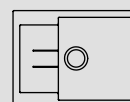

AM6510



### MAXI VASCHE

Le maxi vasche dei lavelli ELEGANCE, praticissime grazie alle grandi dimensioni, sono una soluzione ideale per una cucina spaziosa e per le famiglie numerose.



### DESIGN MINIMAL

Un concentrato di stile e modernità per abbinarsi ad ambienti contemporanei e lineari.

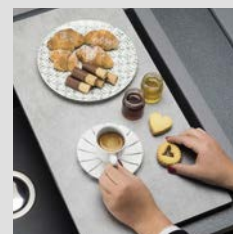

### ACCESSORI CON STILE

I taglieri scorrevoli in HPL, in legno iroko o in polietilene trasformano il lavello in un pratico centro per la preparazione di cibi.

## MISCELATORI CONSIGLIATI



NEWMIX80  
pag. 196



VENMIXL  
pag. 211

# AM11620 / ELEGANCE

Lavello a due vasche più scolapiatti - Reversibile  
1160x500 mm - Base da 80 cm

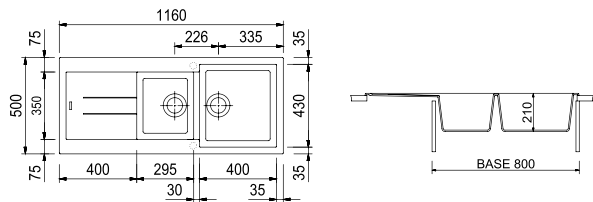

Foro per l'incasso: 1140x480 mm

**ACCESSORI: 2, 4, 6, 9, 10, 11**

# AM9915 / ELEGANCE

Lavello a una vasca grande più una vasca piccola più scolapiatti  
Reversibile - 990x500 mm - Base da 60 cm

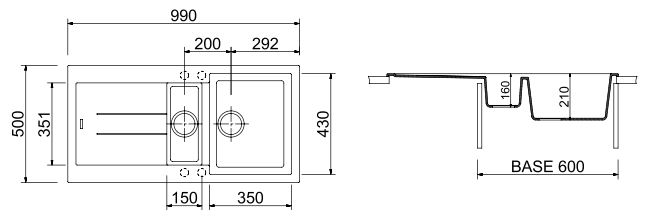

Foro per l'incasso: 970x480 mm

**ACCESSORI: 2, 4, 6, 9, 10, 11**

## MICROULTRAGRANIT



€ IVA esclusa

-  UG 56 JASMINE  
**AM11620 / 56**
-  UG 70 NERO MATT  
**AM11620 / 70**
-  UG 72 TARTUFO  
**AM11620 / 72**
-  UG 90 BIANCO OPALE  
**AM11620 / 90**
-  UG 94 AVENA  
**AM11620 / 94**
-  UG 95 NERO EBONY  
**AM11620 / 95**
-  UG 98 BIANCO  
**AM11620 / 98**

**520**

## ULTRAMETAL

€ IVA esclusa

-  UM 41 ALLUMINIO  
**AM11620 / 41**
-  UM 42 TITANIO  
**AM11620 / 42**
-  UM 14 CONCRETE  
**AM11620 / 14**
-  UM 44 NERO  
**AM11620 / 44**

**550**

## NANOSTONE







€ IVA esclusa

-  NS N1 BIANCO LATTE  
**AM11620 / N1**
-  NS N3 ARGAN  
**AM11620 / N3**
-  NS N4 URBAN GREY  
**AM11620 / N4**
-  NS N6 DEEP BLACK  
**AM11620 / N6**

**640**

## MICROULTRAGRANIT



€ IVA esclusa

-  UG 56 JASMINE  
**AM9915 / 56**
-  UG 70 NERO MATT  
**AM9915 / 70**
-  UG 72 TARTUFO  
**AM9915 / 72**
-  UG 90 BIANCO OPALE  
**AM9915 / 90**
-  UG 94 AVENA  
**AM9915 / 94**
-  UG 95 NERO EBONY  
**AM9915 / 95**
-  UG 98 BIANCO  
**AM9915 / 98**

**520**

## ULTRAMETAL

€ IVA esclusa

-  UM 41 ALLUMINIO  
**AM9915 / 41**
-  UM 42 TITANIO  
**AM9915 / 42**
-  UM 14 CONCRETE  
**AM9915 / 14**
-  UM 44 NERO  
**AM9915 / 44**

**550**

## NANOSTONE

€ IVA esclusa

-  NS N1 BIANCO LATTE  
**AM9915 / N1**
-  NS N3 ARGAN  
**AM9915 / N3**
-  NS N4 URBAN GREY  
**AM9915 / N4**
-  NS N6 DEEP BLACK  
**AM9915 / N6**

**640**

## ACCESSORI CONSIGLIATI



1\_COPHPLON



3\_TAGL44



4\_TAGP66



5\_ONTAGCR



6\_TAGCR



7\_ONVASINX



8\_VAS700N

# AM9910 / ELEGANCE

Lavello a una vasca più scolapiatti - Reversibile  
990x500 mm - Base da 60 cm

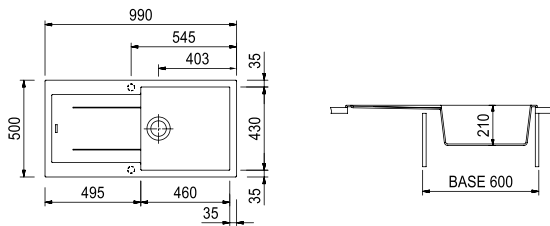





Foro per l'incasso: 970x480 mm

**ACCESSORI: 2, 4, 6, 9, 10, 11**

## MICROULTRAGRANIT





€ IVA esclusa

-  UG 56 JASMINE  
**AM9910 / 56**
-  UG 70 NERO MATT  
**AM9910 / 70**
-  UG 72 TARTUFO  
**AM9910 / 72**
-  UG 90 BIANCO OPALE  
**AM9910 / 90**
-  UG 94 AVENA  
**AM9910 / 94**
-  UG 95 NERO EBONY  
**AM9910 / 95**
-  UG 98 BIANCO  
**AM9910 / 98**

**510**

## ULTRAMETAL





€ IVA esclusa

-  UM 41 ALLUMINIO  
**AM9910 / 41**
-  UM 42 TITANIO  
**AM9910 / 42**
-  UM 14 CONCRETE  
**AM9910 / 14**
-  UM 44 NERO  
**AM9910 / 44**

**540**

## NANOSTONE

€ IVA esclusa

-  NS N1 BIANCO LATTE  
**AM9910 / N1**
-  NS N3 ARGAN  
**AM9910 / N3**
-  NS N4 URBAN GREY  
**AM9910 / N4**
-  NS N6 DEEP BLACK  
**AM9910 / N6**

**630**

# AM8620 / ELEGANCE

Lavello a due vasche  
860x510 mm - Base da 90 cm

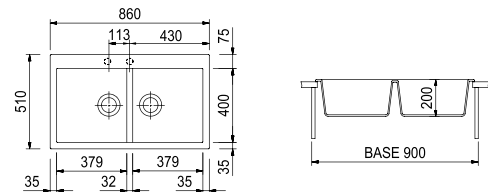

Foro per l'incasso: 840x480 mm

**ACCESSORI: 1, 3, 5, 7, 8, 9, 10, 11**

## MICROULTRAGRANIT



€ IVA esclusa

-  UG 56 JASMINE  
**AM8620 / 56**
-  UG 70 NERO MATT  
**AM8620 / 70**
-  UG 72 TARTUFO  
**AM8620 / 72**
-  UG 90 BIANCO OPALE  
**AM8620 / 90**
-  UG 94 AVENA  
**AM8620 / 94**
-  UG 95 NERO EBONY  
**AM8620 / 95**
-  UG 98 BIANCO  
**AM8620 / 98**

**500**

## ULTRAMETAL

€ IVA esclusa

-  UM 41 ALLUMINIO  
**AM8620 / 41**
-  UM 42 TITANIO  
**AM8620 / 42**
-  UM 14 CONCRETE  
**AM8620 / 14**
-  UM 44 NERO  
**AM8620 / 44**

**530**

## NANOSTONE

€ IVA esclusa

-  NS N1 BIANCO LATTE  
**AM8620 / N1**
-  NS N3 ARGAN  
**AM8620 / N3**
-  NS N4 URBAN GREY  
**AM8620 / N4**
-  NS N6 DEEP BLACK  
**AM8620 / N6**

**620**



9\_SPCESINX



10\_ROLLUP



11\_ROLLMAT

# AM8610 / ELEGANCE

Lavello a una vasca più scolapiatti - Reversibile  
860x500 mm - Base da 50 cm

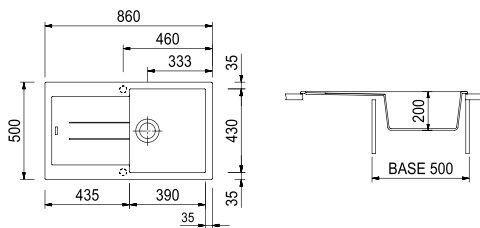

Foro per l'incasso: 840x480 mm

ACCESSORI: 1, 2, 3, 4, 5

# AM7810 / ELEGANCE

Lavello a una vasca più scolapiatti - Reversibile  
780x500 mm - Base da 50 cm

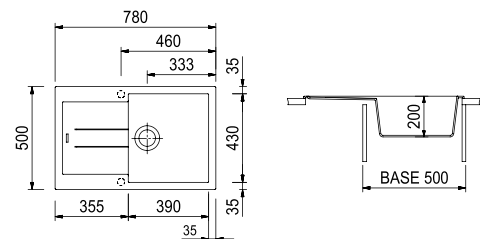

Foro per l'incasso: 760x480 mm

ACCESSORI: 1, 2, 3, 4, 5

## MICROULTRAGRANIT

€ IVA esclusa

UG 56 JASMINE  
AM8610 / 56

UG 70 NERO MATT  
AM8610 / 70

UG 72 TARTUFO  
AM8610 / 72

UG 90 BIANCO OPALE  
AM8610 / 90

470

UG 94 AVENA  
AM8610 / 94

UG 95 NERO EBONY  
AM8610 / 95

UG 98 BIANCO  
AM8610 / 98

## ULTRAMETAL

€ IVA esclusa

UM 41 ALLUMINIO  
AM8610 / 41

UM 42 TITANIO  
AM8610 / 42

UM 14 CONCRETE  
AM8610 / 14

UM 44 NERO  
AM8610 / 44

500

## NANOSTONE

€ IVA esclusa

NS N1 BIANCO LATTE  
AM8610 / N1

NS N3 ARGAN  
AM8610 / N3

NS N4 URBAN GREY  
AM8610 / N4

NS N6 DEEP BLACK  
AM8610 / N6

590

## MICROULTRAGRANIT

€ IVA esclusa

UG 56 JASMINE  
AM7810 / 56

UG 70 NERO MATT  
AM7810 / 70

UG 72 TARTUFO  
AM7810 / 72

UG 94 AVENA  
AM7810 / 94

475

UG 98 BIANCO  
AM7810 / 98

## ULTRAMETAL

€ IVA esclusa

UM 41 ALLUMINIO  
AM7810 / 41

UM 42 TITANIO  
AM7810 / 42

UM 44 NERO  
AM7810 / 44

505

## ACCESSORI CONSIGLIATI



1\_TAGL88



2\_TAGP66



3\_TAGCR



4\_SPCESINX

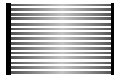

5\_ROLLMAT



6\_SPVASPOL

## AM7815 / ELEGANCE

Lavello a una vasca grande più una vasca piccola più scolapiatti  
Reversibile - 780x500 mm - Base da 60 cm

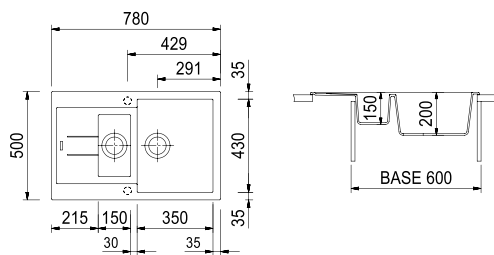





Foro per l'incasso: 760x480 mm

ACCESSORI: 1, 2, 3, 4, 5, 6

### MICROULTRAGRANIT



€ IVA esclusa

-  UG 56  
JASMINE  
AM7815 / 56
-  UG 70  
NERO MATT  
AM7815 / 70
-  UG 72  
TARTUFO  
AM7815 / 72
-  UG 94  
AVENA  
AM7815 / 94
-  UG 98  
BIANCO  
AM7815 / 98

505

### ULTRAMETAL

€ IVA esclusa

-  UM 41  
ALLUMINIO  
AM7815 / 41
-  UM 42  
TITANIO  
AM7815 / 42
-  UM 44  
NERO  
AM7815 / 44

535

## AM6510 / ELEGANCE

Lavello a una vasca più scolapiatti - Reversibile  
650x500 mm - Base da 50 cm

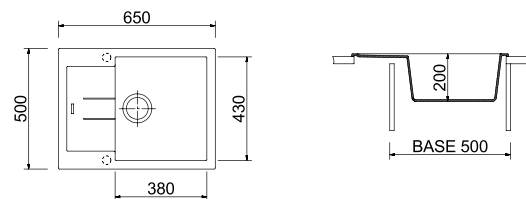





Foro per l'incasso: 630x480 mm

ACCESSORI: 1, 2, 3, 4, 5

### MICROULTRAGRANIT



€ IVA esclusa

-  UG 56  
JASMINE  
AM6510 / 56
-  UG 70  
NERO MATT  
AM6510 / 70
-  UG 72  
TARTUFO  
AM6510 / 72
-  UG 94  
AVENA  
AM6510 / 94
-  UG 98  
BIANCO  
AM6510 / 98

455

### ULTRAMETAL

€ IVA esclusa

-  UM 41  
ALLUMINIO  
AM6510 / 41
-  UM 42  
TITANIO  
AM6510 / 42
-  UM 44  
NERO  
AM6510 / 44

485



LAVELLI



# INFINITY

Linee decise, perfetta proporzione tra le ampie vasche e la superficie d'appoggio: Infinity è la linea dei lavelli che predilige praticità e bellezza estetica. Il design minimal e rigoroso esalta le caratteristiche tecnologiche della nuova finitura nanoSTONE, donando un gradevole effetto seta al tatto e maggiore robustezza alla struttura del lavello per renderlo più resistente e confortevole nel tempo.



## FINITURE



## PLUS



ARIA PURA



ITALIAN  
TECHNOLOGY



100% ECO  
COMPATIBILE

## CORREDO

- Piletta
- Sifone
- Ganci

## INSTALLAZIONE

- Standard



# INFINITY

## CARATTERISTICHE DI PRODOTTO

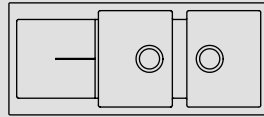

NF11620

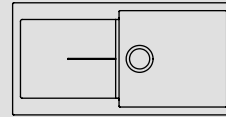

NF9910

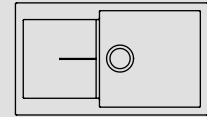

NF8610



### MAXI VASCHE

Le maxi vasche dei lavelli INFINITY, praticissime grazie alle grandi dimensioni, sono una soluzione ideale per una cucina spaziosa e per le famiglie numerose.

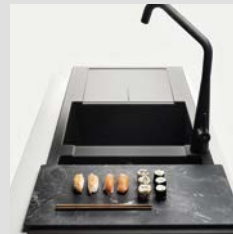

### DESIGN MINIMAL

Linee decise, perfetta proporzione tra le vasche e la superficie d'appoggio: Infinity è la linea dei lavelli che predilige praticità e bellezza estetica.

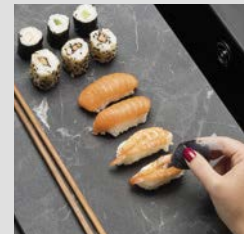

### ACCESSORI CON STILE

I taglieri scorrevoli in HPL, in legno iroko o in polietilene trasformano il lavello in un pratico centro per la preparazione di cibi.

## MISCELATORI CONSIGLIATI



SPRINGP40  
pag. 194



NILO  
pag. 200

## REALTÀ AUMENTATA



Inquadra il qr-code con il tuo smartphone per scoprire i nostri lavelli in realtà aumentata.

# NF11620 / INFINITY

Lavello a due vasche più scolapiatti - Reversibile  
1160x500 mm - Base da 80 cm

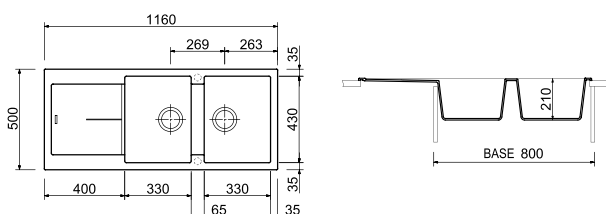

Foro per l'incasso: 1140x480 mm

ACCESSORI: 1, 2, 3, 4, 5

## MICROULTRAGRANIT

€ IVA esclusa



UG 70  
NERO MATT  
NF11620 / 70



UG 72  
TARTUFO  
NF11620 / 72



UG 98  
BIANCO  
NF11620 / 98

470

## NANOSTONE

€ IVA esclusa



NS N1  
BIANCO LATTE  
NF11620 / N1



NS N3  
ARGAN  
NF11620 / N3



NS N4  
URBAN GREY  
NF11620 / N4



NS N6  
DEEP BLACK  
NF11620 / N6

590

## ULTRAMETAL

€ IVA esclusa



UM 41  
ALLUMINIO  
NF11620 / 41



UM 42  
TITANIO  
NF11620 / 42



UM 14  
CONCRETE  
NF11620 / 14



UM 44  
NERO  
NF11620 / 44

500

# NF9910 / INFINITY

Lavello a una vasca più scolapiatti - Reversibile  
990x500 mm - Base da 60 cm

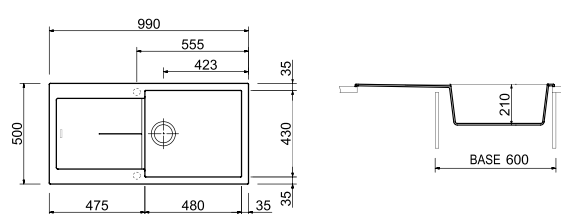

Foro per l'incasso: 970x480 mm

ACCESSORI: 1, 2, 3, 4, 5

## MICROULTRAGRANIT

€ IVA esclusa



UG 70  
NERO MATT  
NF9910 / 70



UG 72  
TARTUFO  
NF9910 / 72



UG 98  
BIANCO  
NF9910 / 98

460

## NANOSTONE

€ IVA esclusa



NS N1  
BIANCO LATTE  
NF9910 / N1



NS N3  
ARGAN  
NF9910 / N3



NS N4  
URBAN GREY  
NF9910 / N4



NS N6  
DEEP BLACK  
NF9910 / N6

580

## ULTRAMETAL

€ IVA esclusa



UM 41  
ALLUMINIO  
NF9910 / 41



UM 42  
TITANIO  
NF9910 / 42



UM 14  
CONCRETE  
NF9910 / 14



UM 44  
NERO  
NF9910 / 44

490

## ACCESSORI CONSIGLIATI



1\_TAGL88

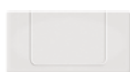

2\_TAGP66



3\_TAGCR



4\_SPCESINX

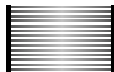

5\_ROLLMAT

# NF8610 / INFINITY

Lavello a una vasca più scolapiatti - Reversibile  
860x500 mm - Base da 60 cm

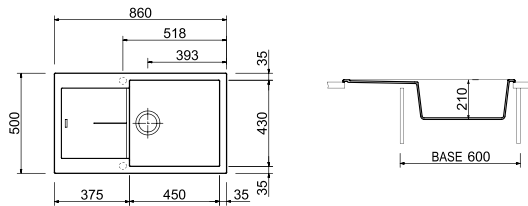

Foro per l'incasso: 840x480 mm

**ACCESSORI: 1, 2, 3, 4, 5**

## MICROULTRAGRANIT

€ IVA esclusa

UG 70  
NERO MATT  
NF8610 / 70

UG 72  
TARTUFO  
NF8610 / 72

UG 98  
BIANCO  
NF8610 / 98

420

## NANOSTONE

€ IVA esclusa

NS N1  
BIANCO LATTE  
NF8610 / N1

NS N3  
ARGAN  
NF8610 / N3

NS N4  
URBAN GREY  
NF8610 / N4

NS N6  
DEEP BLACK  
NF8610 / N6

540

## ULTRAMETAL

€ IVA esclusa

UM 41  
ALLUMINIO  
NF8610 / 41

UM 42  
TITANIO  
NF8610 / 42

UM 14  
CONCRETE  
NF8610 / 14

UM 44  
NERO  
NF8610 / 44

450



LAVELLI



# CORAX

Corax, caratterizzata da forme ricercate, è la linea Plados di alto profilo. Curata nei dettagli, si sposa perfettamente con le cucine moderne e di tendenza. I lavelli sono provvisti di un pratico gocciolatoio e di vasche ampie e molto profonde.



#### FINITURE



#### PLUS



ARIA PURA



ITALIAN  
TECHNOLOGY



100% ECO  
COMPATIBILE

#### CORREDO

- Piletta
- Sifone
- Ganci

#### INSTALLAZIONE

- Standard

# CORAX

## CARATTERISTICHE DI PRODOTTO

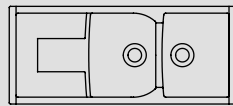

CX1162

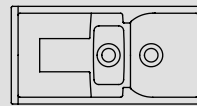

CX0991

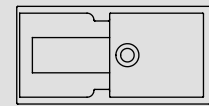

EL9910

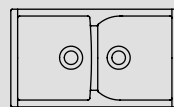

CX0862

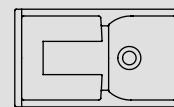

CX0861

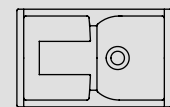

CX0791



### VASCHE AMPIE E PROFONDE

Le vasche della serie CORAX sono profonde 23 cm.

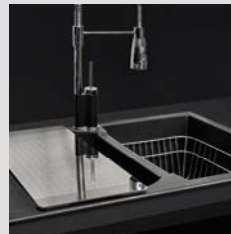

### DESIGN RICERCATO

Corax, caratterizzata da forme ricercate, è la linea Plados di alto profilo. Curata nei dettagli, si sposa perfettamente con le cucine moderne e di tendenza.



### ACCESSORI CONSIGLIATI

Taglieri, cestelli e vaschette aggiungono praticità e design alle funzioni di lavaggio e preparazione dei cibi.

## MISCELATORI CONSIGLIATI



NEWMIX90  
pag. 196



SPIRIT  
pag. 200

## CX1162 / CORAX

Lavello a due vasche più scolapiatti - Reversibile  
1160x500 mm - Base da 80 cm

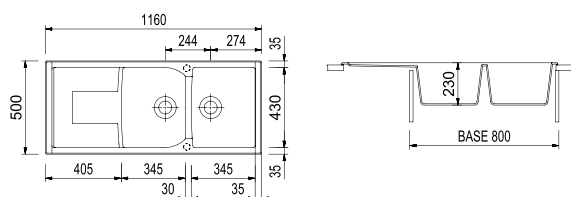

Foro per l'incasso: 1140x480 mm

ACCESSORI: 1, 2, 3, 4, 5

### MICROULTRAGRANIT

€ IVA esclusa

### ULTRAMETAL

€ IVA esclusa

UG 56  
JASMINE  
CX1162 / 56

UM 41  
ALLUMINIO  
CX1162 / 41

UG 70  
NERO MATT  
CX1162 / 70

UM 42  
TITANIO  
CX1162 / 42

500

UG 72  
TARTUFO  
CX1162 / 72

UM 44  
NERO  
CX1162 / 44

UG 90  
BIANCO OPALE  
CX1162 / 90

470

UG 94  
AVENA  
CX1162 / 94

UG 95  
NERO EBONY  
CX1162 / 95

UG 98  
BIANCO  
CX1162 / 98

## CX0991 / CORAX

Lavello a una vasca grande più una vasca piccola più scolapiatti  
Reversibile - 990x500 mm - Base da 60 cm

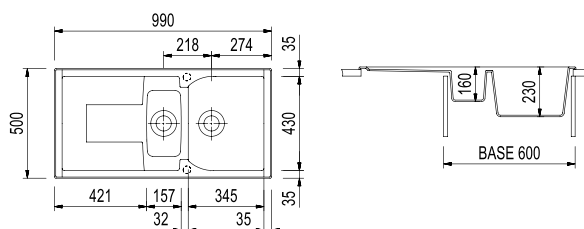

Foro per l'incasso: 970x480 mm

ACCESSORI: 1, 2, 3, 4, 5, 6

### MICROULTRAGRANIT

€ IVA esclusa

### ULTRAMETAL

€ IVA esclusa

UG 56  
JASMINE  
CX0991 / 56

UM 41  
ALLUMINIO  
CX0991 / 41

UG 70  
NERO MATT  
CX0991 / 70

UM 42  
TITANIO  
CX0991 / 42

500

UG 72  
TARTUFO  
CX0991 / 72

UM 44  
NERO  
CX0991 / 44

UG 90  
BIANCO OPALE  
CX0991 / 90

470

UG 94  
AVENA  
CX0991 / 94

UG 95  
NERO EBONY  
CX0991 / 95

UG 98  
BIANCO  
CX0991 / 98

### ACCESSORI CONSIGLIATI



1\_TAGL88

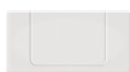

2\_TAGP66



3\_TAGCR



4\_SPCESINX

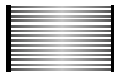

5\_ROLLMAT



6\_SPVASPOL



## EL9910 / CORAX

Lavello a una vasca più scolapiatti - Reversibile  
990x500 mm - Base da 60 cm

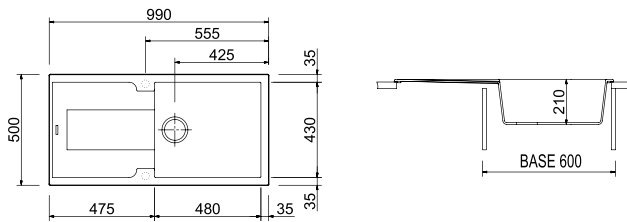
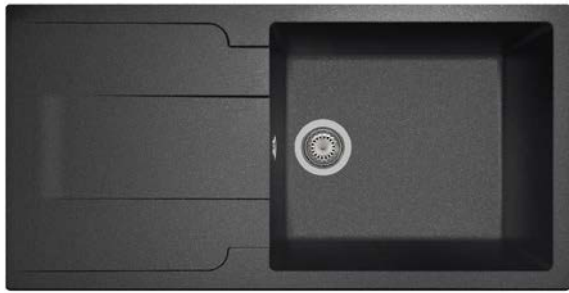





Foro per l'incasso: 970x480 mm

ACCESSORI: 1, 2, 3, 4, 5

### MICROULTRAGRANIT



€ IVA esclusa

-  UG 70  
NERO MATT  
EL9910 / 70
-  UG 72  
TARTUFO  
EL9910 / 72
-  UG 94  
AVENA  
EL9910 / 94
-  UG 98  
BIANCO  
EL9910 / 98

460

### ULTRAMETAL

€ IVA esclusa

-  UM 41  
ALLUMINIO  
EL9910 / 41
-  UM 42  
TITANIO  
EL9910 / 42
-  UM 44  
NERO  
EL9910 / 44

490

## CX0862 / CORAX

Lavello a due vasche  
860x500 mm - Base da 90 cm

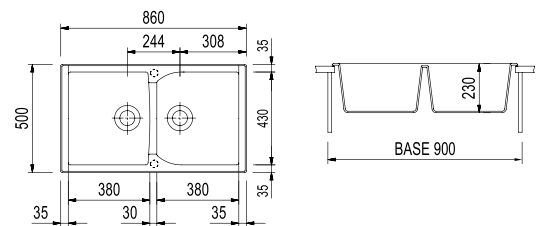

Foro per l'incasso: 840x480 mm

ACCESSORI: 1, 2, 3, 4, 5

### MICROULTRAGRANIT



€ IVA esclusa

-  UG 56  
JASMINE  
CX0862 / 56
-  UG 70  
NERO MATT  
CX0862 / 70
-  UG 72  
TARTUFO  
CX0862 / 72
-  UG 90  
BIANCO OPALE  
CX0862 / 90
-  UG 94  
AVENA  
CX0862 / 94
-  UG 95  
NERO EBONY  
CX0862 / 95
-  UG 98  
BIANCO  
CX0862 / 98

440

### ULTRAMETAL

€ IVA esclusa

-  UM 41  
ALLUMINIO  
CX0862 / 41
-  UM 42  
TITANIO  
CX0862 / 42
-  UM 44  
NERO  
CX0862 / 44

470

## CX0861 / CORAX

Lavello a una vasca più scolapiatti - Reversibile  
860x500 mm - Base da 45 cm

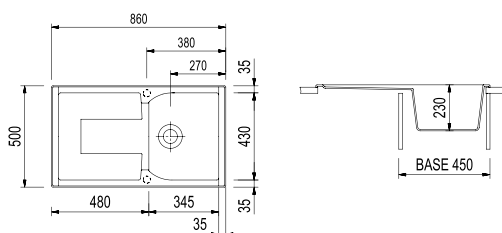

Foro per l'incasso: 840x480 mm

**ACCESSORI: 1, 2, 3, 4, 5**

### MICROULTRAGRANIT

€ IVA esclusa

### ULTRAMETAL

€ IVA esclusa



UG 56  
JASMINE  
CX0861 / 56



UM 41  
ALLUMINIO  
CX0861 / 41



UG 70  
NERO MATT  
CX0861 / 70



UM 42  
TITANIO  
CX0861 / 42

**440**



UG 72  
TARTUFO  
CX0861 / 72



UM 44  
NERO  
CX0861 / 44



UG 90  
BIANCO OPALE  
CX0861 / 90

**410**



UG 94  
AVENA  
CX0861 / 94



UG 95  
NERO EBONY  
CX0861 / 95



UG 98  
BIANCO  
CX0861 / 98

## CX0791 / CORAX

Lavello a una vasca più scolapiatti - Reversibile  
790x500 mm - Base da 45 cm

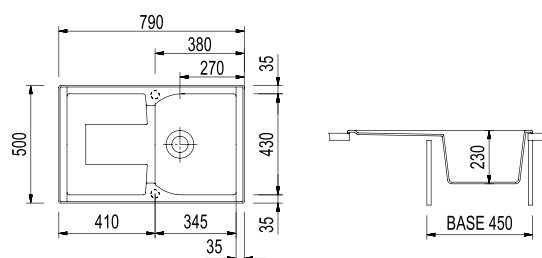

Foro per l'incasso: 770x480 mm

**ACCESSORI: 1, 2, 3, 4, 5**

### MICROULTRAGRANIT

€ IVA esclusa

### ULTRAMETAL

€ IVA esclusa



UG 56  
JASMINE  
CX0791 / 56



UM 41  
ALLUMINIO  
CX0791 / 41



UG 70  
NERO MATT  
CX0791 / 70



UM 42  
TITANIO  
CX0791 / 42

**445**



UG 72  
TARTUFO  
CX0791 / 72



UM 44  
NERO  
CX0791 / 44



UG 90  
BIANCO OPALE  
CX0791 / 90

**415**



UG 94  
AVENA  
CX0791 / 94



UG 95  
NERO EBONY  
CX0791 / 95



UG 98  
BIANCO  
CX0791 / 98

### ACCESSORI CONSIGLIATI



1\_TAGL88

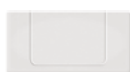

2\_TAGP66



3\_TAGCR



4\_SPCESINX

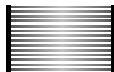

5\_ROLLMAT





LAVELLI

# ATLANTIC

Sobria, pulita e molto funzionale, la linea Atlantic è proposta in molte finiture e può essere convenientemente installata su qualsiasi tipologia di cucine componibili.



#### FINITURE



#### PLUS



ARIA PURA



ITALIAN  
TECHNOLOGY



100% ECO  
COMPATIBILE

#### CORREDO

- Piletta
- Sifone
- Ganci

#### INSTALLAZIONE

- Standard

# ATLANTIC

## CARATTERISTICHE DI PRODOTTO

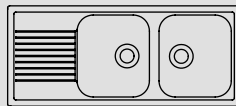

PL1162

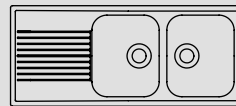

AT1162

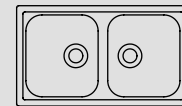

PL0862

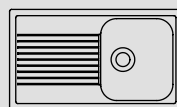

PL0861

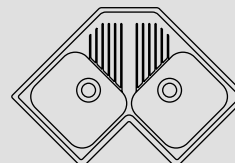

FTA8320

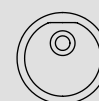

PL4351



### ANGOLI ARROTONDATI

Gli angoli arrotondati rendono più facili le operazioni di pulizia.

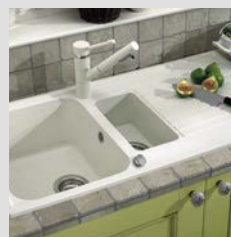

### STILE SENZA TEMPO

Atlantic con le sue linee semplici e funzionali si adatta a qualsiasi tipologia di cucine componibili.



### ACCESSORI CONSIGLIATI

Taglieri, cestelli e vaschette aggiungono praticità e design alle funzioni di lavaggio e preparazione cibi.

## MISCELATORI CONSIGLIATI



VENMIXEXT  
pag. 210



SLIMFIX  
pag. 211

# PL1162 / ATLANTIC

Lavello a due vasche più scolapiatti - Reversibile  
1160x500 mm - **Base da 90 cm**

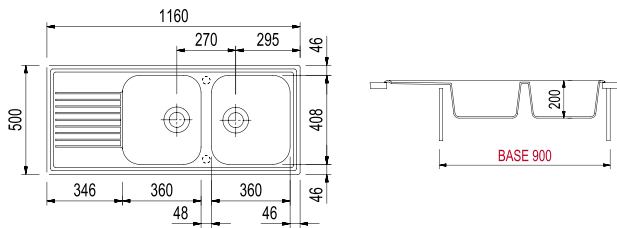

Foro per l'incasso: 1140x480 mm

**ACCESSORI: 3, 4, 5, 6, 7, 8**

# AT1162 / ATLANTIC

Lavello a due vasche più scolapiatti - Reversibile  
1160x500 mm - **Base da 80 cm**

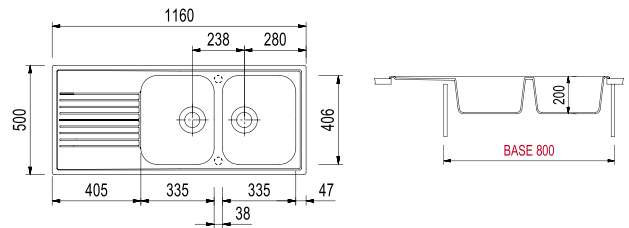

Foro per l'incasso: 1140x480 mm





**ACCESSORI: 1, 2, 5, 6, 7, 8**

## MICROULTRAGRANIT



€ IVA esclusa

## ULTRAMETAL

€ IVA esclusa

-  UG 56 JASMINE  
**PL1162 / 56**
-  UG 70 NERO MATT  
**PL1162 / 70**
-  UG 94 AVENA  
**PL1162 / 94**
-  UG 98 BIANCO  
**PL1162 / 98**

**420**

-  UM 41 ALLUMINIO  
**PL1162 / 41**
-  UM 42 TITANIO  
**PL1162 / 42**
-  UM 44 NERO  
**PL1162 / 44**





**450**

## MICROULTRAGRANIT

€ IVA esclusa

## ULTRAMETAL

€ IVA esclusa

-  UG 56 JASMINE  
**AT1162 / 56**
-  UG 70 NERO MATT  
**AT1162 / 70**
-  UG 94 AVENA  
**AT1162 / 94**
-  UG 98 BIANCO  
**AT1162 / 98**

**420**

-  UM 41 ALLUMINIO  
**AT1162 / 41**
-  UM 42 TITANIO  
**AT1162 / 42**
-  UM 44 NERO  
**AT1162 / 44**

**450**

## ACCESSORI CONSIGLIATI



1\_TAGL88

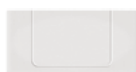

2\_TAGP66



3\_PLTAGIRK



4\_PLTAGPOL



5\_TAGCR



6\_SPCESINX



7\_ROLLUP



8\_ROLLMAT



## PL0862 / ATLANTIC

Lavello a due vasche  
860x500 mm - Base da 90 cm

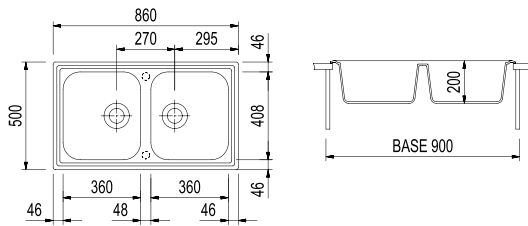





Foro per l'incasso: 840x480 mm

**ACCESSORI: 3, 4, 5, 6, 7, 8**

### MICROULTRAGRANIT



€ IVA esclusa

-  UG 56  
JASMINE  
**PL0862 / 56**
-  UG 70  
NERO MATT  
**PL0862 / 70**
-  UG 94  
AVENA  
**PL0862 / 94**
-  UG 98  
BIANCO  
**PL0862 / 98**

**400**

### ULTRAMETAL

€ IVA esclusa

-  UM 41  
ALLUMINIO  
**PL0862 / 41**
-  UM 42  
TITANIO  
**PL0862 / 42**
-  UM 44  
NERO  
**PL0862 / 44**

**430**

## PL0861 / ATLANTIC

Lavello a una vasca più scolapiatti - Reversibile  
860x500 mm - Base da 45 cm

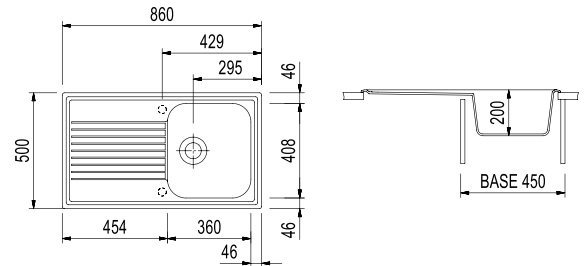





Foro per l'incasso: 840x480 mm

**ACCESSORI: 3, 4, 5, 6, 7, 8**

### MICROULTRAGRANIT



€ IVA esclusa

-  UG 56  
JASMINE  
**PL0861 / 56**
-  UG 70  
NERO MATT  
**PL0861 / 70**
-  UG 94  
AVENA  
**PL0861 / 94**
-  UG 98  
BIANCO  
**PL0861 / 98**

**390**

### ULTRAMETAL

€ IVA esclusa

-  UM 41  
ALLUMINIO  
**PL0861 / 41**
-  UM 42  
TITANIO  
**PL0861 / 42**
-  UM 44  
NERO  
**PL0861 / 44**

**420**

# FTA8320 / ATLANTIC

Lavello angolare a due vasche più scolapiatti  
830x500 mm - Base angolare 90x90 cm

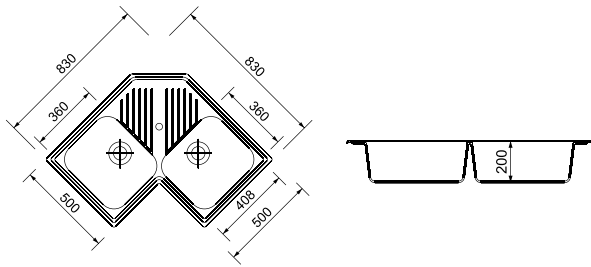





Foro per l'incasso: VEDI DIMA

ACCESSORI: 1, 2, 3, 4, 5, 6

## MICROULTRAGRANIT



€ IVA esclusa

-  UG 56  
JASMINE  
FTA8320 / 56
-  UG 70  
NERO MATT  
FTA8320 / 70
-  UG 94  
AVENA  
FTA8320 / 94
-  UG 98  
BIANCO  
FTA8320 / 98

665

## ULTRAMETAL

€ IVA esclusa

-  UM 41  
ALLUMINIO  
FTA8320 / 41
-  UM 42  
TITANIO  
FTA8320 / 42
-  UM 44  
NERO  
FTA8320 / 44

695

# PL4351 / ATLANTIC

Lavello tondo  
Ø 435 mm - Base da 40/45 cm

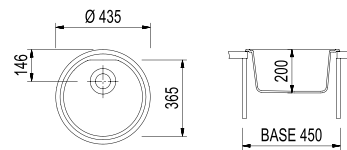



Foro per l'incasso: Ø 410 mm

ACCESSORI: /

## MICROULTRAGRANIT

€ IVA esclusa

-  UG 70  
NERO MATT  
PL4351 / 70
-  UG 94  
AVENA  
PL4351 / 94
-  UG 98  
BIANCO  
PL4351 / 98

350

## ACCESSORI CONSIGLIATI



1\_TAGL88

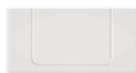

2\_TAGP66



3\_TAGCR



4\_SPCESINX



5\_ROLLUP

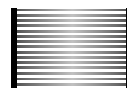

6\_ROLLMAT





LAVELLI



# SPAZIO

Un perfetto mix di eleganza e tradizione, il sapiente equilibrio tra forme, estetica e funzioni, rendono Spazio la linea evergreen di Plados. Il pratico gocciolatoio e il bordino perimetrale di contenimento esaltano la praticità e la funzionalità del lavello.



#### FINITURE



#### PLUS



ARIA PURA



ITALIAN  
TECHNOLOGY



100% ECO  
COMPATIBILE

#### CORREDO

- Piletta
- Sifone
- Ganci

#### INSTALLAZIONE

- Standard

# SPAZIO

## CARATTERISTICHE DI PRODOTTO

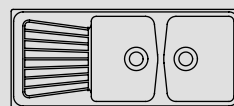

SP1162

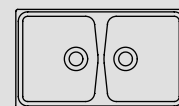

SP0862

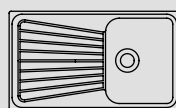

SP0861

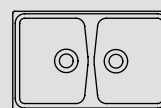

SP0792

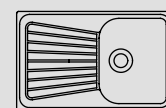

SP0791



### STILE COUNTRY

Gli angoli arrotondati rendono più facili le operazioni di pulizia.



### PRATICITÀ E FUNZIONALITÀ

Il pratico gocciolatoio ed il bordo perimetrale di contenimento esaltano la praticità e la funzionalità del lavello.



### ACCESSORI CONSIGLIATI

TAGL88: un tagliere in legno iroko di altissima qualità, particolarmente durevole ed estremamente resistente alle escursioni termiche e all'umidità.

## MISCELATORI CONSIGLIATI



TIZMIXEXT  
Pag. 210



VENMIX20  
pag. 213

## SP1162 / SPAZIO

Lavello a due vasche più scolapiatti - Reversibile  
1160x500 mm - Base da 80 cm

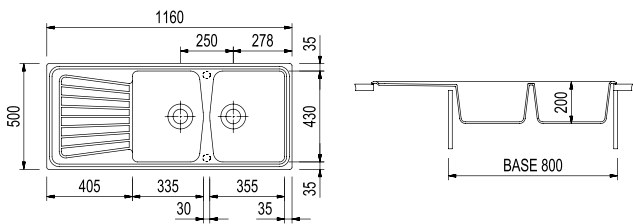





Foro per l'incasso: 1140x480 mm

ACCESSORI: 1, 2, 3, 4, 5, 6

### MICROULTRAGRANIT

€ IVA esclusa

-  UG 56  
JASMINE  
SP1162 / 56
-  UG 70  
NERO MATT  
SP1162 / 70
-  UG 94  
AVENA  
SP1162 / 94
-  UG 98  
BIANCO  
SP1162 / 98

420

### ULTRAQUARTZ

€ IVA esclusa

-  UQ 66  
TERRA DI FRANCIA  
SP1162 / 66

420

## SP0862 / SPAZIO

Lavello a due vasche - Reversibile  
860x500 mm - Base da 90 cm

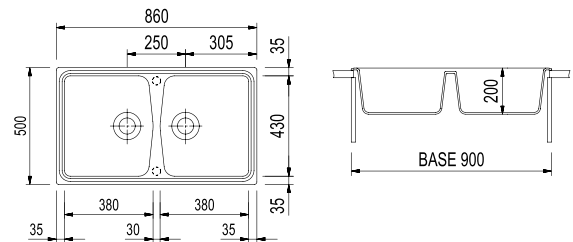





Foro per l'incasso: 840x480 mm

ACCESSORI: 1, 2, 3, 4, 5, 6

### MICROULTRAGRANIT

€ IVA esclusa

-  UG 56  
JASMINE  
SP0862 / 56
-  UG 70  
NERO MATT  
SP0862 / 70
-  UG 94  
AVENA  
SP0862 / 94
-  UG 98  
BIANCO  
SP0862 / 98

400

### ULTRAQUARTZ

€ IVA esclusa

-  UQ 66  
TERRA DI FRANCIA  
SP0862 / 66

400

### ACCESSORI CONSIGLIATI



1\_TAGL88

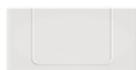

2\_TAGP66



3\_TAGCR



4\_SPCESINX



5\_ROLLUP

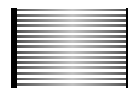

6\_ROLLMAT



## SP0861 / SPAZIO

Lavello a una vasca più scolapiatti - Reversibile  
860x500 mm - Base da 45 cm

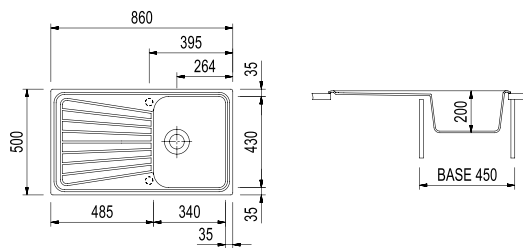





Foro per l'incasso: 840x480 mm

**ACCESSORI: 1, 2, 3, 4, 5, 6**

### MICROULTRAGRANIT

€ IVA esclusa

-  UG 56  
JASMINE  
**SP0861 / 56**
-  UG 70  
NERO MATT  
**SP0861 / 70**
-  UG 94  
AVENA  
**SP0861 / 94**
-  UG 98  
BIANCO  
**SP0861 / 98**

**390**

### ULTRAQUARTZ

€ IVA esclusa

-  UQ 66  
TERRA DI FRANCIA  
**SP0861 / 66** **390**

## SP0792 / SPAZIO

Lavello a due vasche  
790x500 mm - Base da 80 cm

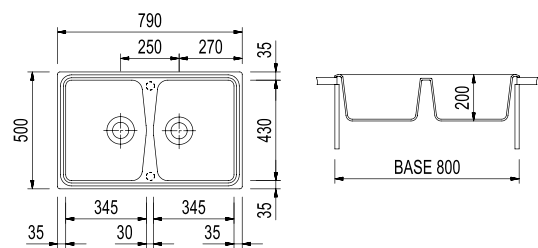





Foro per l'incasso: 770x480 mm

**ACCESSORI: 1, 2, 3, 4, 5, 6**

### MICROULTRAGRANIT

€ IVA esclusa

-  UG 56  
JASMINE  
**SP0792 / 56**
-  UG 70  
NERO MATT  
**SP0792 / 70**
-  UG 94  
AVENA  
**SP0792 / 94**
-  UG 98  
BIANCO  
**SP0792 / 98**

**405**

### ULTRAQUARTZ

€ IVA esclusa

-  UQ 66  
TERRA DI FRANCIA  
**SP0792 / 66** **405**

# SP0791 / SPAZIO

Lavello a una vasca più scolapiatti - Reversibile  
790x500 mm - Base da 45 cm

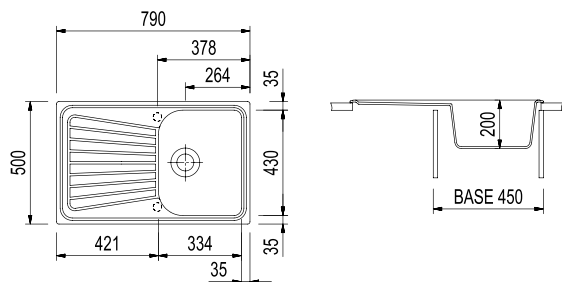





Foro per l'incasso: 770x480 mm

**ACCESSORI: 1, 2, 3, 4, 5, 6**

## MICROULTRAGRANIT

€ IVA esclusa

-  UG 56  
JASMINE  
**SP0791 / 56**
-  UG 70  
NERO MATT  
**SP0791 / 70**
-  UG 94  
AVENA  
**SP0791 / 94**
-  UG 98  
BIANCO  
**SP0791 / 98**

**395**

## ULTRAQUARTZ

€ IVA esclusa

-  UQ 66  
TERRA DI FRANCIA  
**SP0791 / 66** **395**

## ACCESSORI CONSIGLIATI



1\_TAGL88

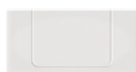

2\_TAGP66



3\_TAGCR



4\_SPCESINX



5\_ROLLUP

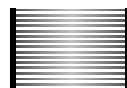

6\_ROLLMAT





LAVELLI

# HARMONY

Forme speciali e dimensioni particolari nei lavelli delle linee Harmony. Modelli in grado di soddisfare tutte le esigenze e le necessità da parte della Clientela, anche la più sofisticata. Estetica tradizionale che trova la naturale collocazione nelle cucine country e old style. Modelli provvisti del pratico bordino perimetrale di contenimento.





#### FINITURE



#### PLUS



ARIA PURA



ITALIAN  
TECHNOLOGY



100% ECO  
COMPATIBILE

#### CORREDO

- Piletta
- Sifone
- Ganci

#### INSTALLAZIONE

- Standard

# HARMONY

## CARATTERISTICHE DI PRODOTTO

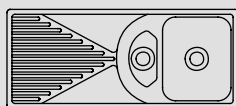

PL11610

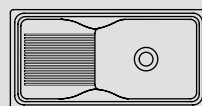

DB09910

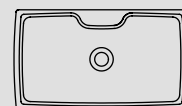

HR0860

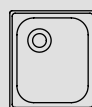

HR4321



NK05110

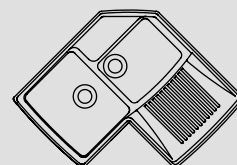

HRA832



### UNA LINEA VERSATILE

I modelli HARMONY hanno dimensioni e forme particolari per soddisfare ogni necessità.

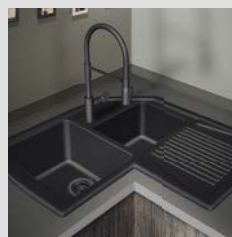

### FORME TRADIZIONALI

I lavelli HARMONY trovano la loro naturale collocazione in cucine country e old-style



### ACCESSORI CONSIGLIATI

Taglieri, cestelli e vaschette aggiungono praticità e design alle funzioni di lavaggio e preparazione cibi.

## MISCELATORI CONSIGLIATI



EASY  
pag. 212



TIZEK  
pag. 212

# PL11610 / HARMONY

Lavello a una vasca grande più una vasca piccola più scolapiatti  
Reversibile - 1160x500 mm - Base da 60 cm



N.B. - La vasca piccola funge anche da troppopieno

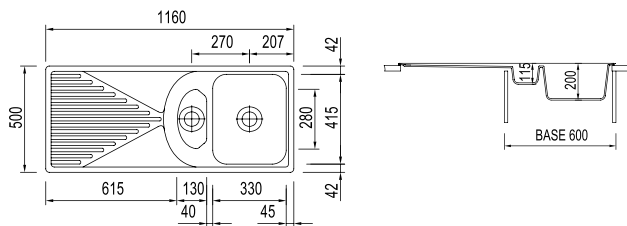



Foro per l'incasso: 1140x480 mm

ACCESSORI: 1, 3, 4, 5, 6, 7

## MICROULTRAGRANIT

€ IVA esclusa

-  UG 70  
NERO MATT  
PL11610 / 70
-  UG 94  
AVENA  
PL11610 / 94
-  UG 98  
BIANCO  
PL11610 / 98

500

# DB09910 / HARMONY

Lavello a una vasca più scolapiatti - Reversibile  
990x500 mm - Base da 60-80 cm

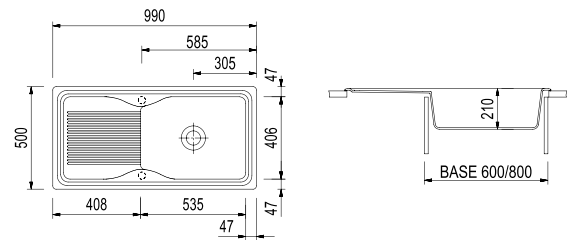





Foro per l'incasso: 970x480 mm

ACCESSORI: 1, 3, 4, 5, 6, 7

## MICROULTRAGRANIT



€ IVA esclusa

-  UG 56  
JASMINE  
DB09910 / 56
-  UG 70  
NERO MATT  
DB09910 / 70
-  UG 94  
AVENA  
DB09910 / 94
-  UG 98  
BIANCO  
DB09910 / 98

505

## ULTRAMETAL

€ IVA esclusa

-  UM 41  
ALLUMINIO  
DB09910 / 41
-  UM 42  
TITANIO  
DB09910 / 42
-  UM 44  
NERO  
DB09910 / 44

535

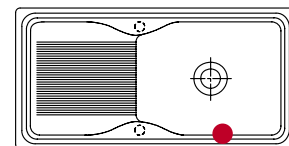

● Posizione standard del troppopieno:  
Installazione su base da 60 cm (80 cm se terminale)

## ACCESSORI CONSIGLIATI



1\_TAGL88



2\_TAGIRK1

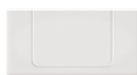

3\_TAGP66



4\_TAGCR



5\_SPCESINX



6\_ROLLUP



7\_ROLLMAT



# HR0860 / HARMONY

Lavello a una vasca  
880x500 mm - Base da 90 cm

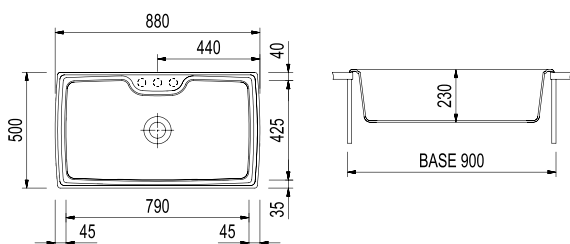





Foro per l'incasso: 840x480 mm

ACCESSORI: 2, 6, 7

## MICROULTRAGRANIT



€ IVA esclusa

-  UG 56  
JASMINE  
HR0860 / 56
-  UG 70  
NERO MATT  
HR0860 / 70
-  UG 94  
AVENA  
HR0860 / 94
-  UG 98  
BIANCO  
HR0860 / 98

440

## ULTRAMETAL

€ IVA esclusa

-  UM 41  
ALLUMINIO  
HR0860 / 41
-  UM 42  
TITANIO  
HR0860 / 42
-  UM 44  
NERO  
HR0860 / 44

470

# HR4321 / HARMONY

Lavello a una vasca - Reversibile  
432x500 mm - Base da 45-50 cm



**Installazione standard:**  
Inseribile in una base da 45 cm

**Installazione longitudinale:**  
Inseribile in una base da 50 cm

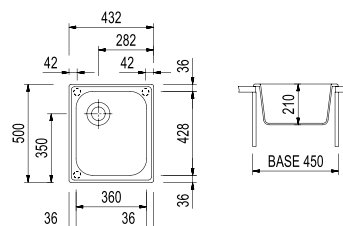





Foro per l'incasso: 410x480 mm

ACCESSORI: 1, 3, 4, 5, 6, 7

## MICROULTRAGRANIT



€ IVA esclusa

-  UG 56  
JASMINE  
HR4321 / 56
-  UG 70  
NERO MATT  
HR4321 / 70
-  UG 94  
AVENA  
HR4321 / 94
-  UG 98  
BIANCO  
HR4321 / 98

395

## ULTRAMETAL

€ IVA esclusa

-  UM 41  
ALLUMINIO  
HR4321 / 41
-  UM 42  
TITANIO  
HR4321 / 42
-  UM 44  
NERO  
HR4321 / 44

425

## NK05110 / HARMONY

Lavello tondo a una vasca con banco rubinetteria  
 ø 510 mm - Base da 45 cm

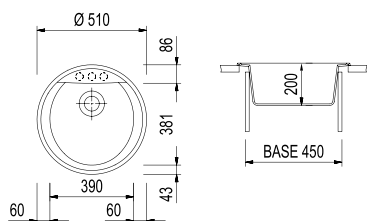



Foro per l'incasso: ø 490 mm

ACCESSORI: /

MICROULTRAGRANIT

€ IVA esclusa

-  UG 70  
NERO MATT  
NK05110 / 70
-  UG 94  
AVENA  
NK05110 / 94
-  UG 98  
BIANCO  
NK05110 / 98

395

## HRA832 / HARMONY

Lavello angolare a due vasche più scolapiatti  
 842 x 500 mm - Base angolare 90x90 cm

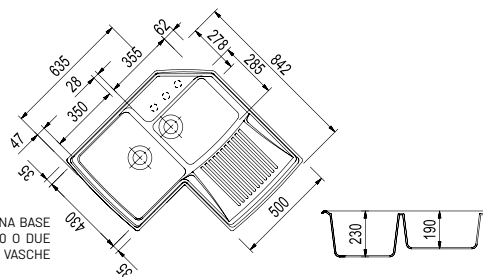





NOTA: INSERIBILE IN UNA BASE ANGOLARE DA 900X900 O DUE BASI ANGOLARI DA 900. VASCHE SOLO A SINISTRA.

Foro per l'incasso: VEDI DIMA

ACCESSORI: 1, 2, 3, 4, 5

MICROULTRAGRANIT



€ IVA esclusa

-  UG 56  
JASMINE  
HRA832 / 56
-  UG 70  
NERO MATT  
HRA832 / 70
-  UG 94  
AVENA  
HRA832 / 94
-  UG 98  
BIANCO  
HRA832 / 98

725

ULTRAMETAL

€ IVA esclusa

-  UM 41  
ALLUMINIO  
HRA832 / 41
-  UM 42  
TITANIO  
HRA832 / 42
-  UM 44  
NERO  
HRA832 / 44

755

### ACCESSORI CONSIGLIATI



1\_TAGL88

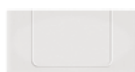

2\_TAGP66



3\_SPCESINX



4\_ROLLUP



5\_ROLLMAT

# MONTAGGIO LAVELLI SOTTO-TOP

Tutti i lavelli Plados possono essere installati in maniera tradizionale, cioè incassati nel piano di lavoro della cucina; molti possono essere installati sotto-top. I disegni mostrano tre tipiche modalità d'installazione sotto-top dei lavelli Plados. **Il kit per l'installazione sotto-top è già compreso nell'imballo dei lavelli predisposti per tale installazione** (Serie ONE per installazione sotto-top). Per tutti gli altri modelli, il kit è disponibile come accessorio optional (codice **GANCIST06**).

Dal nostro sito web [www.pladostelma.com](http://www.pladostelma.com), nella pagina di ogni lavello, alla voce **Downloads** possono essere scaricati i **disegni per la realizzazione dell'apertura sul piano top**. I files sono disponibili per il download in formato **DXF, DWG e PDF**.

## SOLUZIONE A



I bordi del top e del lavello coincidono (Soluzione suggerita)

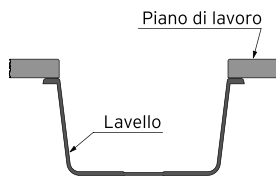

Questa soluzione:

- Esalta l'estetica.
- Facilita la pulizia;
- Ottimizza l'igiene.

## SOLUZIONE B



Il top si estende oltre il bordo del lavello, su tutti i lati. Il bordo del lavello è nascosto sotto il piano top.

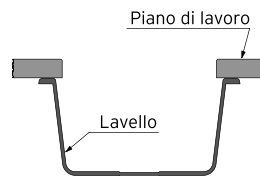
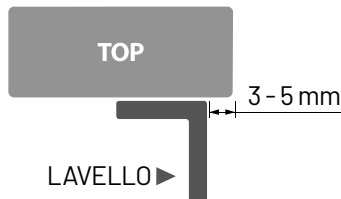

Questa soluzione:

- Semplifica l'installazione;
- Facilita la pulizia.

## SOLUZIONE C



Il bordo del lavello è parzialmente visibile

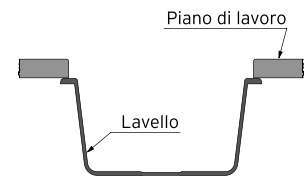
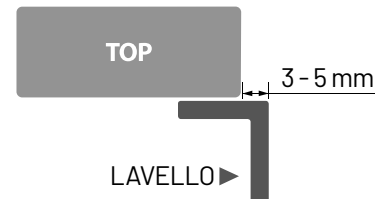

Questa soluzione:

- Facilita la pulizia;
- Ottimizza l'igiene.

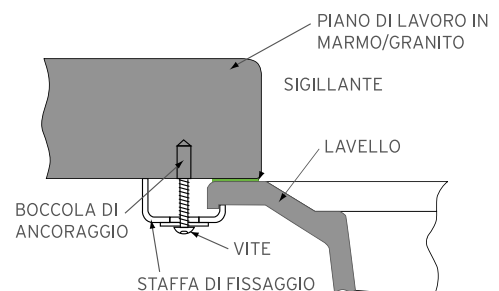
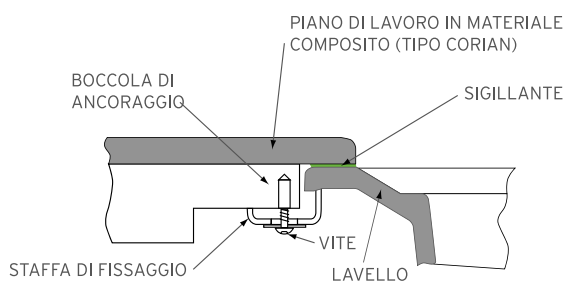



# LAVELLI IN ACCIAIO INOX

La superficie completamente liscia, la raffinatezza dell'acciaio inossidabile, l'alta tecnologia impiegata nella produzione, rendono i lavelli inox Plados Telma estremamente funzionali. La cura meticolosa delle finiture e dei dettagli ci consente di raggiungere i massimi livelli di qualità e stile.

Le serie MAKI sono divise per tipologia di installazione e i lavelli sono disponibili in diverse dimensioni per soddisfare ogni esigenza di mercato; sono caratterizzati da vasche molto capienti e realizzati con il migliore acciaio inox AISI 304 18/10, che li rende completamente riciclabili, igienici e resistenti alla corrosione.

- 132 Serie **MAKI MIX-R**  
con foro per miscelatore - installazione SLIM - FILOTOP
- 134 Serie **MAKI R**  
senza foro per miscelatore - installazione SLIM - FILOTOP
- 136 Serie **MAKI ST-R**  
senza foro per miscelatore - installazione SOTTO-TOP
  
- 138 Serie **OLYMPUS/VINTAGE**
- 142 Serie **UNIVERSAL**



# made in italy

significa cura per i dettagli e alta qualità

## VASCHE RAGGIO 12 mm

Il raggio interno dei lavelli MAKI rende ancora **più facile la pulizia**, **riduce ulteriormente il deposito di calcare** e consente una **maggiore igiene**, senza rinunciare a un **design essenziale**, moderno e minimalista.

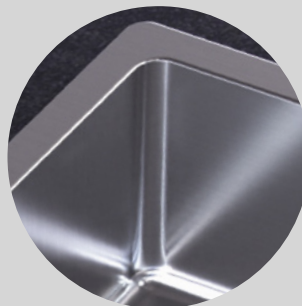

## SPESSORE REGOLARE 1 mm

Rende il prodotto **ancora più robusto**, resistente e destinato a durare nel tempo. Lo spessore omogeneo è possibile grazie a un'innovativa tecnologia di lavorazione a freddo.

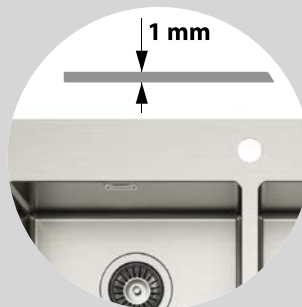

## NIENTE LINEE DI DRENAGGIO VISIBILI NEL FONDO VASCA

Un nuovo sistema di deformazione consente di creare sul fondo della vasca la giusta inclinazione per far defluire l'acqua **senza che si vedano solchi o pieghe**. Il fondo appare perfettamente liscio e omogeneo e l'acqua può defluire completamente.



## TROPPOPIENO DESIGN

Ogni lavello è dotato di piletta in acciaio inox AISI 304, tappo e troppopieno, per garantire il massimo livello di sicurezza. Il **raffinato troppopieno rettangolare** conferisce un valore aggiunto in termini di eleganza e design, per un prodotto di altissima qualità totalmente **MADE IN ITALY**.



**Scegli il tipo di installazione, scegli la serie. Semplice!**



**INCASSO SLIM**



**MAKI MIX-R**

Con banco rubinetteria



**FILO-TOP**



**MAKI R**

Senza banco rubinetteria



**SOTTOTOP**



**MAKI ST-R**

Senza banco rubinetteria

# MAKI MIX-R



INCASSO SLIM



FILO-TOP



MADE IN  
ITALY



100% ECO  
COMPATIBILE



## SR7520 / MAKI MIX-R

Lavello a due vasche - 745x510 mm - Base 80 cm

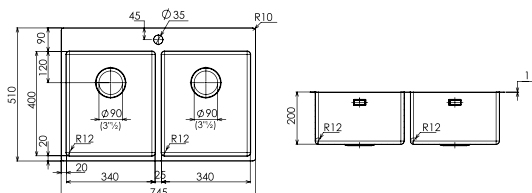

Foro per l'incasso: 735x495 mm

**ACCESSORI: 1, 2, 3, 4, 5, 6, 7**

€ IVA  
esclusa



ACCIAIO SATINATO  
SR7520

**920**

## SR7500 / MAKI MIX-R

Lavello a una vasca - 740x510 mm - Base 80 cm

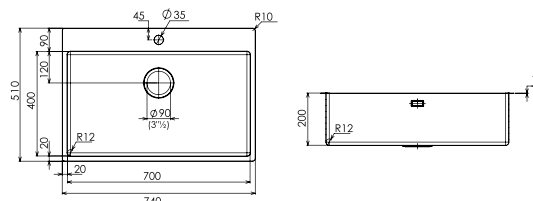

Foro per l'incasso: 730x495 mm

**ACCESSORI: 1, 2, 3, 4, 5, 6, 7**

€ IVA  
esclusa



ACCIAIO SATINATO  
SR7500

**710**

## SR5500 / MAKI MIX-R

Lavello a una vasca - 540x510 mm - Base 60 cm

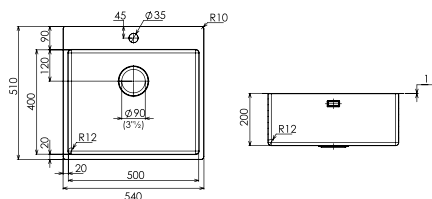

Foro per l'incasso: 530x495 mm

**ACCESSORI: 1, 2, 3, 4, 5, 6, 7**

€ IVA  
esclusa



ACCIAIO SATINATO  
SR5500

**620**

## SR3900 / MAKI MIX-R

Lavello a una vasca - 380x510 mm - Base 45 cm

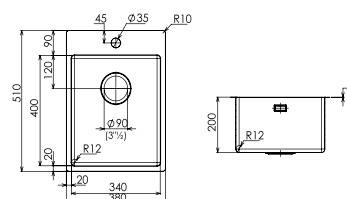

Foro per l'incasso: 370x495 mm

**ACCESSORI: 1, 2, 3, 4, 5, 6, 7**

€ IVA  
esclusa



ACCIAIO SATINATO  
SR3900

**560**

### ACCESSORI CONSIGLIATI



1\_COPHPLON



2\_TAGL88



3\_TAGP66



4\_ONTAGCR



5\_SPCESINX



6\_ROLLUP



7\_ROLLMAT

# MAKI R



INCASSO SLIM



FILO-TOP



MADE IN  
ITALY



100% ECO  
COMPATIBILE

## MR7420 / MAKI R

Lavello a due vasche - 745x440 mm - Base 80 cm

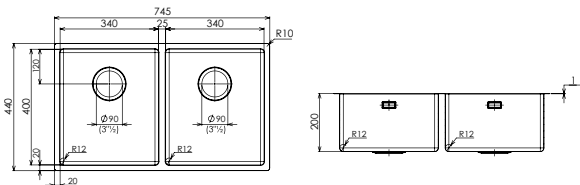

Foro per l'incasso: 735x430 mm

**ACCESSORI: 1, 2, 3, 4, 5, 6, 7**

€ IVA  
esclusa



ACCIAIO SATINATO  
**MR7420** **800**

## MR7400 / MAKI R

Lavello a una vasca - 740x440 mm - Base 80 cm

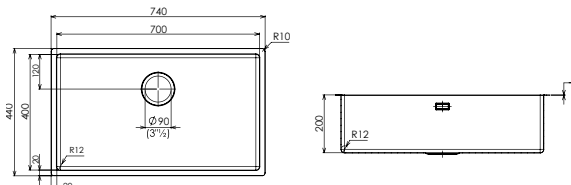

Foro per l'incasso: 730x430 mm

**ACCESSORI: 1, 2, 3, 4, 5, 6, 7**

€ IVA  
esclusa



ACCIAIO SATINATO  
**MR7400** **515**

## MR5400 / MAKI R

Lavello a una vasca - 540x440 mm - Base 60 cm

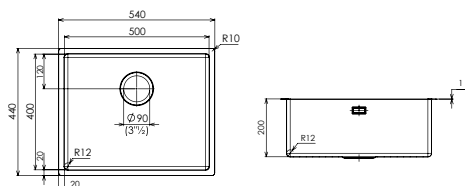

Foro per l'incasso: 530x430 mm

**ACCESSORI: 1, 2, 3, 4, 5, 6, 7**

€ IVA  
esclusa



ACCIAIO SATINATO  
**MR5400** **435**

## MR3800 / MAKI R

Lavello a una vasca - 380x440 mm - Base 45 cm

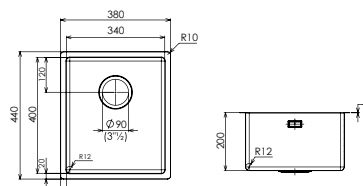

Foro per l'incasso: 370x430 mm

**ACCESSORI: 1, 2, 3, 4, 5, 6, 7**

€ IVA  
esclusa



ACCIAIO SATINATO  
**MR3800** **390**

### ACCESSORI CONSIGLIATI



1\_COPHPLON



2\_TAGL88



3\_TAGP66



4\_ONTAGCR



5\_SPCESINX



6\_ROLLUP



7\_ROLLMAT

**MAKI ST-R**



**INSTALLAZIONE  
SOTTO-TOP**



**MADE IN  
ITALY**



**100% ECO  
COMPATIBILE**

## SL7420 / MAKI ST-R

Lavello a due vasche - 745x440 mm - Base 80 cm

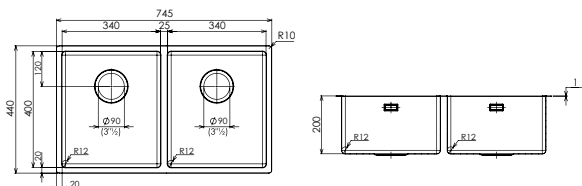

Foro per l'incasso: 705x400 mm

**ACCESSORI: 1, 2, 3, 4, 5, 6, 7**

€ IVA esclusa



ACCIAIO SATINATO  
**SL7420** **750**

## SL7400 / MAKI ST-R

Lavello a una vasca - 740x440 mm - Base 80 cm

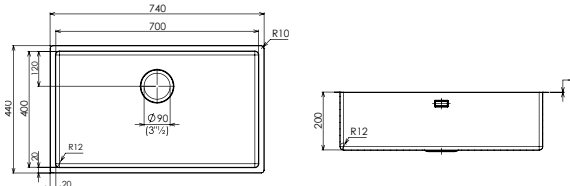

Foro per l'incasso: 700x400 mm

**ACCESSORI: 1, 2, 3, 4, 5, 6, 7**

€ IVA esclusa



ACCIAIO SATINATO  
**SL7400** **470**

## SL5400 / MAKI ST-R

Lavello a una vasca - 540x440 mm - Base 60 cm

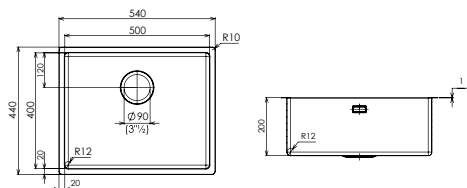

Foro per l'incasso: 500x400 mm

**ACCESSORI: 1, 2, 3, 4, 5, 6, 7**

€ IVA esclusa



ACCIAIO SATINATO  
**SL5400** **390**

## SL3800 / MAKI ST-R

Lavello a una vasca - 380x440 mm - Base 45 cm

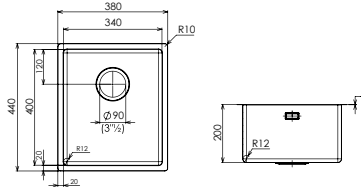

Foro per l'incasso: 340x400 mm

**ACCESSORI: 1, 2, 3, 4, 5, 6, 7**

€ IVA esclusa



ACCIAIO SATINATO  
**SL3800** **345**

### ACCESSORI CONSIGLIATI



1\_COPHPLON



2\_TAGL88



3\_TAGP66



4\_ONTAGCR



5\_SPCESINX



6\_ROLLUP



7\_ROLLMAT

LAVELLI



# OLYMPUS/VINTAGE

Le linee tradizionali e la forza dell'acciaio inossidabile fanno di OLYMPUS una linea versatile, con un caratteristico gocciolatoio che si adatta ad ambienti classici e moderni.

VINTAGE raggruppa modelli dalle forme particolari, adatti a soddisfare ogni esigenza del mercato.



ITALIAN  
TECHNOLOGY



100% ECO  
COMPATIBILE

## CO1162\_ / OLYMPUS

Lavello a due vasche più scolapiatti - 1160x500 mm - Base 80 cm

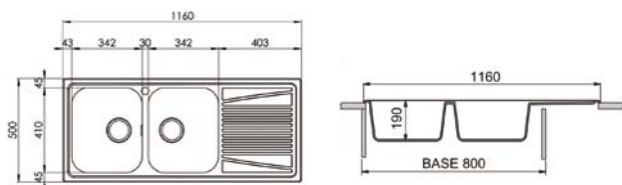

Foro per l'incasso: 1135x475 mm

**ACCESSORI: 1, 2, 3, 4, 5**

€ IVA esclusa



ACCIAIO SATINATO

**CO11621**

Scolapiatti a destra

**365**

**CO11622**

Scolapiatti a sinistra

## VI1001\_ / OLYMPUS

Lavello a una vasca più scolapiatti - 1000x500 mm - Base 60/80 cm

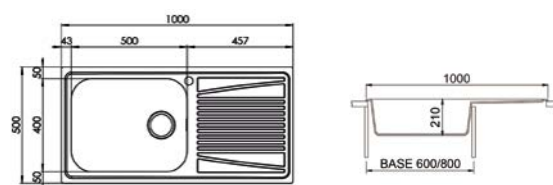

Foro per l'incasso: 975x475 mm

**ACCESSORI: 1, 2, 3, 4, 5**

€ IVA esclusa



ACCIAIO SATINATO

**VI10011**

Scolapiatti a destra

**400**

**VI10012**

Scolapiatti a sinistra

## CO08620 / OLYMPUS

Lavello a due vasche - 860x500 mm - Base 90 cm

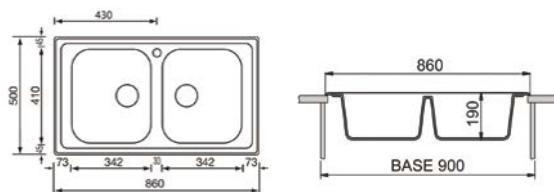

Foro per l'incasso: 835x475 mm

**ACCESSORI: 1, 2, 3, 4, 5**

€ IVA esclusa



ACCIAIO SATINATO  
**CO08620**

**340**

## CO0861\_ / OLYMPUS

Lavello a una vasca più scolapiatti - 860x500 mm - Base 45 cm

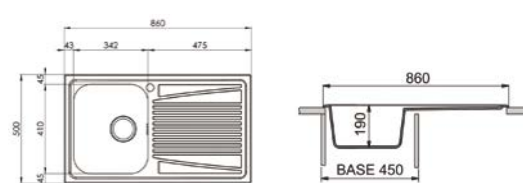

Foro per l'incasso: 835x475 mm

**ACCESSORI: 1, 2, 3, 4, 5**

€ IVA esclusa



ACCIAIO SATINATO

**CO08611**

Scolapiatti a destra

**275**

**CO08612**

Scolapiatti a sinistra

### ACCESSORI CONSIGLIATI



1\_TAGL88

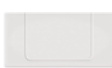

2\_TAGP66



3\_SPCESINX



4\_ROLLUP



5\_ROLLMAT

## C007920 / OLYMPUS

Lavello a due vasche - 790x500 mm - Base 80 cm

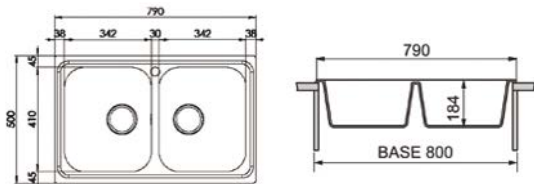

Foro per l'incasso: 775x480 mm

**ACCESSORI: 1, 2, 3, 4, 5**

€ IVA esclusa

ACCAIO SATINATO  
C007920 **340**

## C00791\_ / OLYMPUS

Lavello a una vasca più scolapiatti - 790x500 mm - Base 45 cm

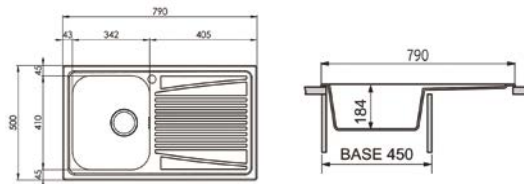

Foro per l'incasso: 775x480 mm

**ACCESSORI: 1, 2, 3, 4, 5**

€ IVA esclusa

ACCAIO SATINATO  
C007911 Scolapiatti a destra **275**  
C007912 Scolapiatti a sinistra

## VI08600 / VINTAGE

Lavello a una vasca - 860x510 mm - Base 80 cm

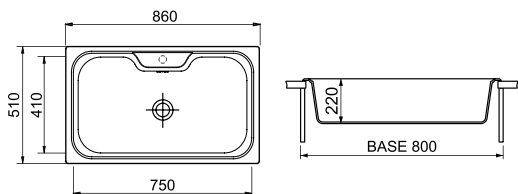

Foro per l'incasso: 840x490 mm

**ACCESSORI: 1, 2, 3, 4, 5**

€ IVA esclusa

ACCAIO SATINATO  
VI08600 **600**

## LISP000431S / VINTAGE

Lavello tondo - ø 435 mm - Base 45 cm

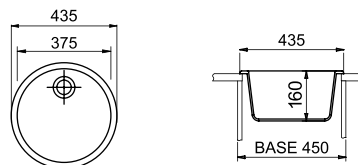

Foro per l'incasso: ø 410 mm

**ACCESSORI: /**

€ IVA esclusa

ACCAIO SATINATO  
LISP000431S **185**

### ACCESSORI CONSIGLIATI



1\_TAGL88

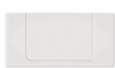

2\_TAGP66



3\_SPCESINX



4\_ROLLUP



5\_ROLLMAT



## LISP838320S / VINTAGE

Lavello angolare a due vasche più scolapiatti  
830x500 mm - Base angolare 90x90 cm

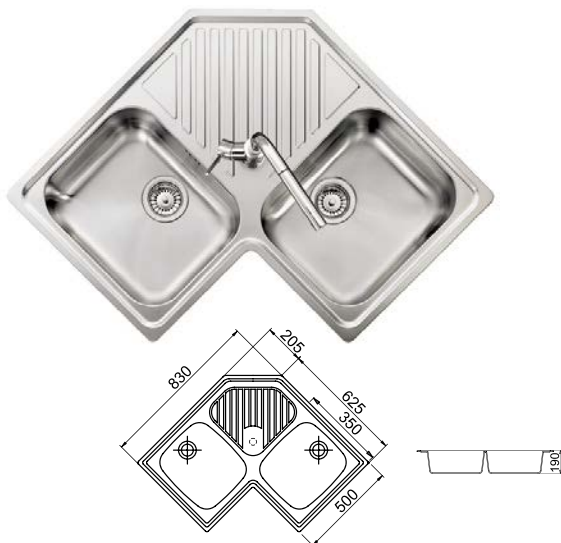

Foro per l'incasso: VEDI DIMA

**ACCESSORI: 1, 2, 3, 4, 5**

€ IVA  
esclusa



ACCIAIO SATINATO  
LISP838320S

**710**

## VIA832\_ / VINTAGE

Lavello angolare a due vasche più scolapiatti  
830x500 mm - Base angolare 90x90 cm

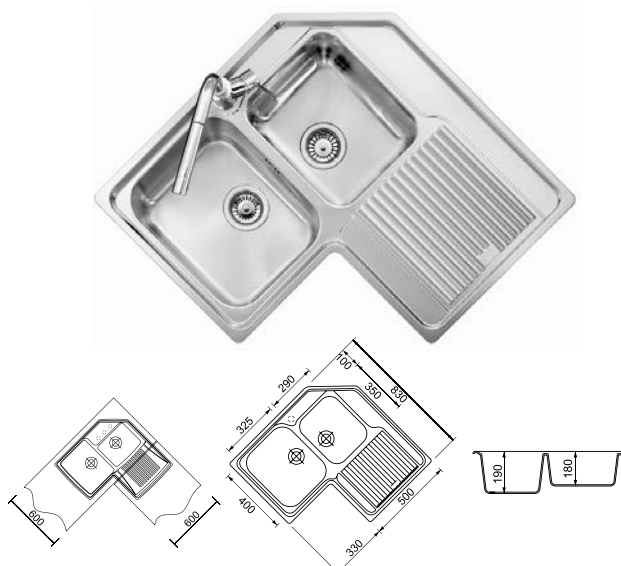

Foro per l'incasso: VEDI DIMA

**ACCESSORI: 1, 2, 3, 4, 5**

€ IVA  
esclusa



**VIA8321**  
Scolapiatti a destra  
**VIA8322**  
Scolapiatti a sinistra

**870**

## LISP504410S60 / VINTAGE

Lavello a una vasca - 440x500 mm - Base 45 cm



Foro per l'incasso: 415x475 mm

**ACCESSORI: 1, 2, 4, 5**

€ IVA  
esclusa



ACCIAIO SATINATO  
LISP504410S60

**178**

LAVELLI



# UNIVERSAL

Universal è la linea dalle forme tradizionali  
che unisce semplicità e convenienza.



ITALIAN  
TECHNOLOGY



100% ECO  
COMPATIBILE

## TL1162\_ / UNIVERSAL

Lavello a due vasche più scolapiatti - 1160x500 mm - Base 80 cm

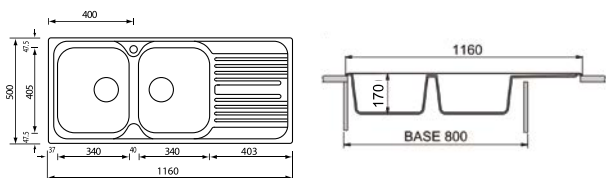

Foro per l'incasso: 1135x475 mm

**ACCESSORI: 1, 2, 3, 4, 5**

€ IVA esclusa



ACCIAIO SATINATO

**TL11621**

Scolapiatti a destra

**300**

**TL11622**

Scolapiatti a sinistra

## TL08620 / UNIVERSAL

Lavello a due vasche - 860x500 mm - Base 90 cm

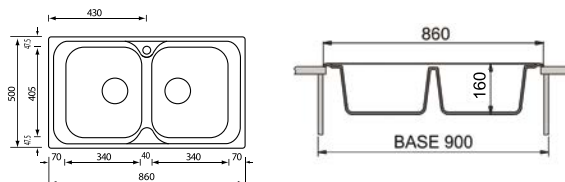

Foro per l'incasso: 835x475 mm

**ACCESSORI: 1, 2, 3, 4, 5**

€ IVA esclusa



ACCIAIO SATINATO  
**TL08620**

**255**

## TL0861\_ / UNIVERSAL

Lavello a una vasca più scolapiatti  
860x500 mm - Base 45 cm

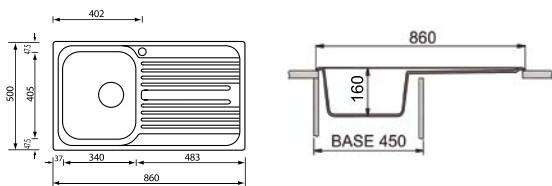

Foro per l'incasso: 835x475 mm

**ACCESSORI: 1, 2, 3, 4, 5**

€ IVA esclusa



ACCIAIO SATINATO

**TL08611**

Scolapiatti a destra

**230**

**TL08612**

Scolapiatti a sinistra

### ACCESSORI CONSIGLIATI



1\_TAGL88

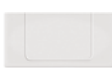

2\_TAGP66



3\_SPCESINX



4\_ROLLUP



5\_ROLLMAT





<b>COPRIVASCA IN HPL</b>	166
<b>ACCESSORI COORDINATI</b>	167
<b>ACCESSORI DESIGN</b>	173
<b>TAGLIERI</b>	174
<b>VASCHETTE</b>	176
<b>TRITARIFIUTI</b>	177
<b>MANUTENZIONE E PULIZIA</b>	178
<b>ALTRI ACCESSORI</b>	179

**PLADOS TELMA**

# GLI ACCESSORI CHE FANNO LA DIFFERENZA



**ROLLMAT**

Un gocciolatoio pieghevole con barre a sezione rettangolare, per una maggiore stabilità. Disponibile in 4 colori.



**COPRI VASCA**

Una pratica superficie aggiuntiva, utile durante la preparazione dei cibi, ideale per i lavelli sprovvisti di gocciolatoio.

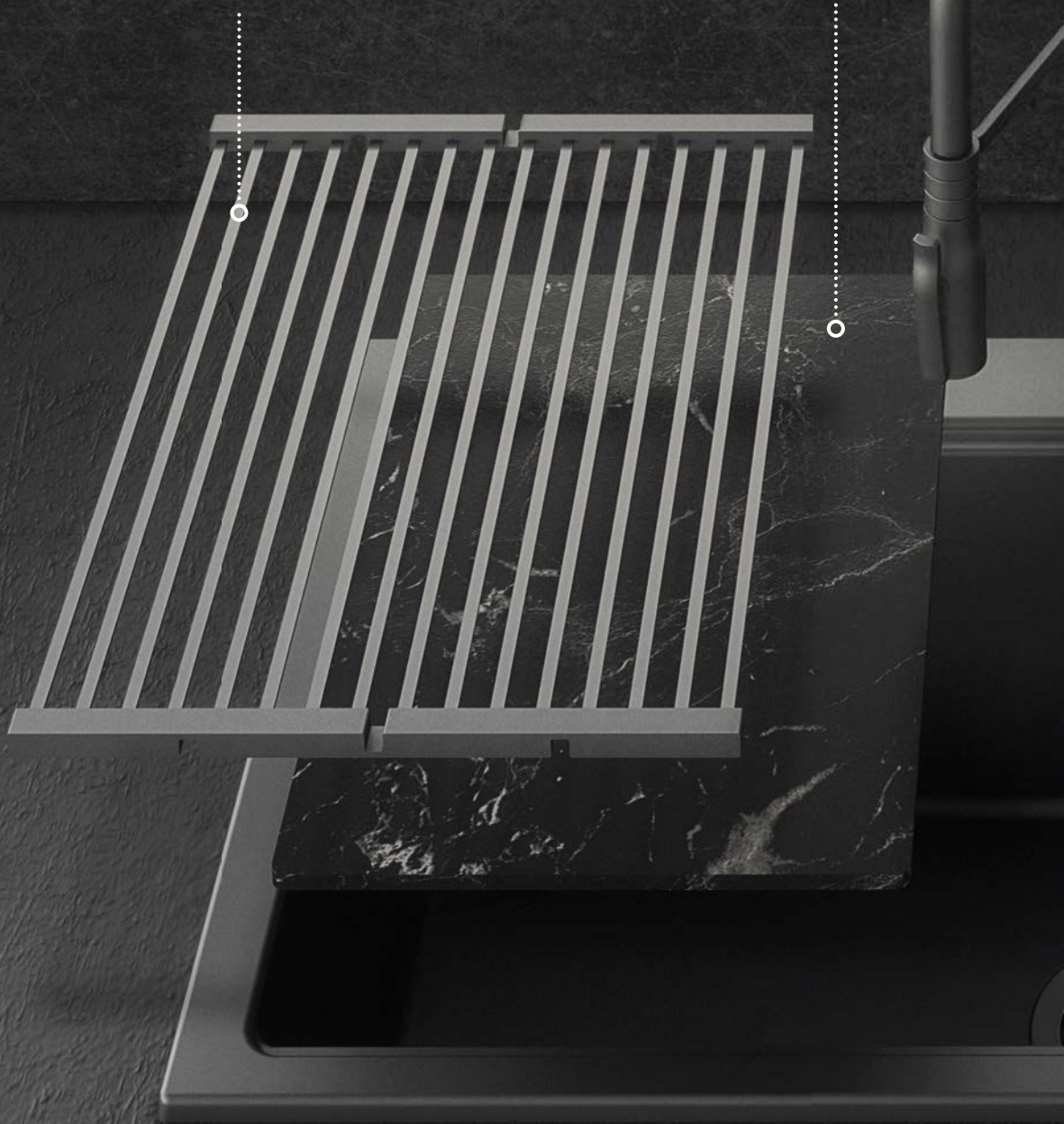

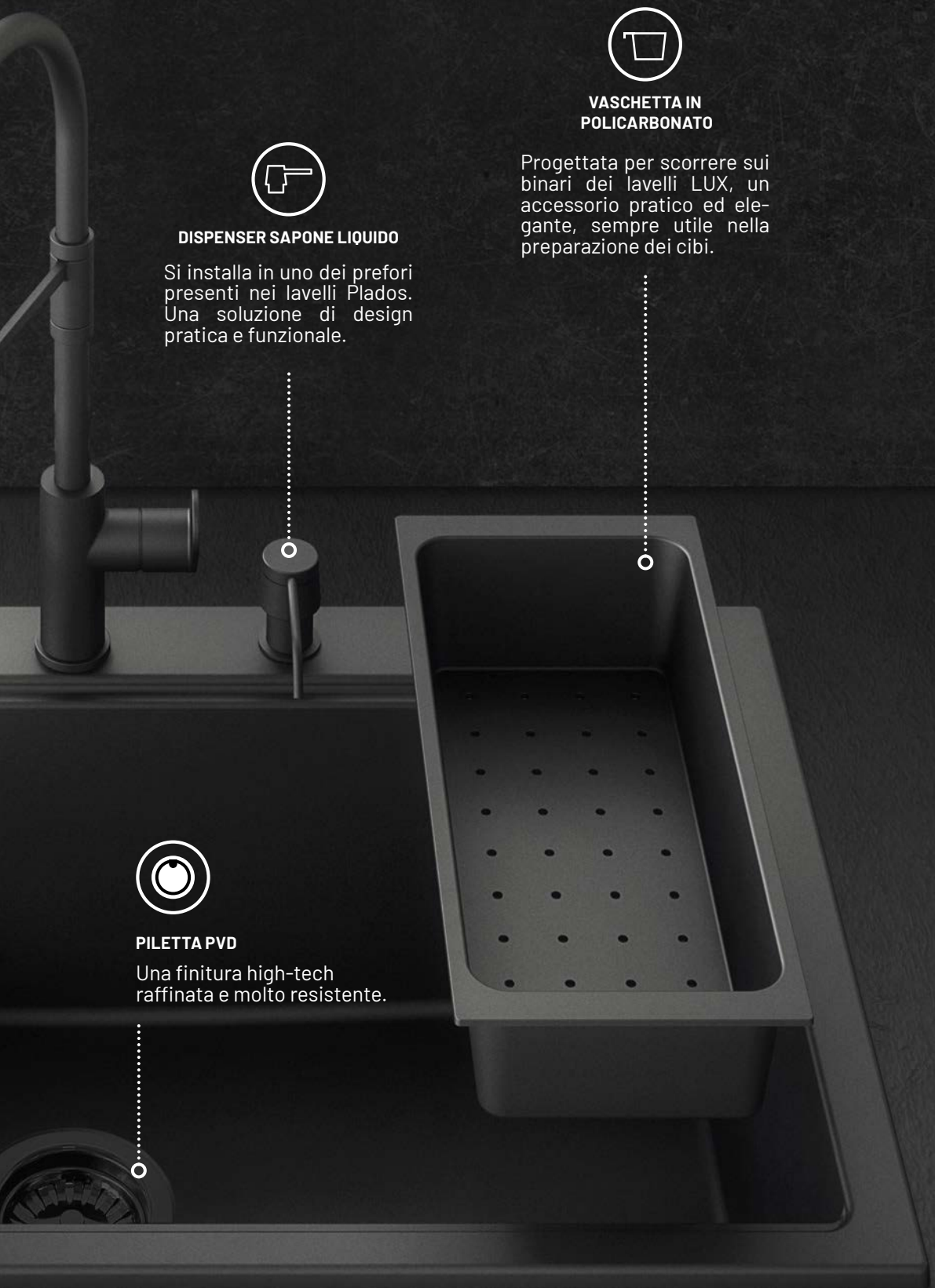

**DISPENSER SAPONE LIQUIDO**

Si installa in uno dei prefori presenti nei lavelli Plados. Una soluzione di design pratica e funzionale.



**VASCHETTA IN POLICARBONATO**

Progettata per scorrere sui binari dei lavelli LUX, un accessorio pratico ed elegante, sempre utile nella preparazione dei cibi.



**PILETTA PVD**

Una finitura high-tech raffinata e molto resistente.

# COPRIVASCA

IN HPL



FINITURE DISPONIBILI:



TORTORA



CEMENTO



ARDESIA

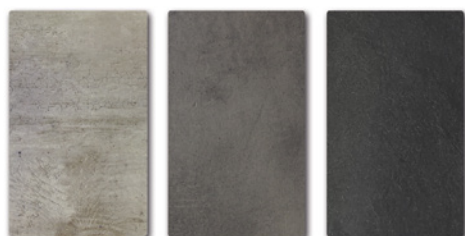

CODICE	MISURA	DESCRIZIONE	COLORI DISPONIBILI	€ iva esclusa
<b>COPHPLON</b>	414X250	Coprivasca per serie ONE inclusi i modelli sotto-top ed integrati. Per AM8620 incluse le versioni sotto-top e integrata.	- CPHPLON/TOR - CPHPLON/CEM - CPHPLON/ARD	<b>133</b>



CODICE	MISURA	DESCRIZIONE	COLORI DISPONIBILI	€ iva esclusa
<b>COPHPLX1</b>	423X280	Coprivasca a scorrimento interno per CT9010	- CPHPLX1/TOR - CPHPLX1/CEM - CPHPLX1/ARD	<b>125</b>



CODICE	MISURA	DESCRIZIONE	COLORI DISPONIBILI	€ iva esclusa
<b>COPHPLX2</b>	405X430	Coprivasca a scorrimento interno per modello LX8610 e LX8620 <b>ATTENZIONE! Il codice CPHPLX2... si riferisce al singolo coprivasca e non alla coppia.</b>	- CPHPLX2/TOR - CPHPLX2/CEM - CPHPLX2/ARD	<b>140</b>



## ACCESSORI COORDINATI - CANNA DI FUCILE



MISCELATORE CONSIGLIATO:  
Mod. NEMO, finitura PVD Gun Metal



NEW

CODICE	MISURA	DESCRIZIONE	€ iva esclusa
<b>KITPVD1</b>	ø 90 mm	Piletta a una via, 1 griglia troppopieno rettangolare, 1 griglia troppopieno rotonda, in PVD Gun Metal. Può essere richiesto anche successivamente all'ordine del lavello. Compatibile con tutte le pilette standard da 3,5"	<b>80</b>



NEW

CODICE	MISURA	DESCRIZIONE	€ iva esclusa
<b>KITPVD2</b>	ø 90 mm	Piletta a due vie, 1 griglia troppopieno rettangolare, 1 griglia troppopieno rotonda, in PVD Gun Metal. Può essere richiesto anche successivamente all'ordine del lavello. Compatibile con tutte le pilette standard da 3,5"	<b>135</b>

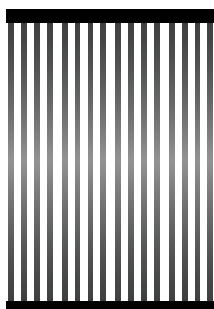

CODICE	MISURA	DESCRIZIONE	€ iva esclusa
<b>ROLLMAT-BL</b>	442X316	Gocciolatoio pieghevole in silicone e acciaio inox, in PVD Gun Metal	<b>125</b>

## ACCESSORI COORDINATI - ORO



MISCELATORE CONSIGLIATO:  
Mod. NEMO, finitura PVD Oro



NEW

CODICE	MISURA	DESCRIZIONE	€ iva esclusa
<b>KITPVD1G</b>	ø 90 mm	Piletta a una via, 1 griglia troppopieno rettangolare, 1 griglia troppopieno rotonda, in PVD color oro. Può essere richiesto anche successivamente all'ordine del lavello. Compatibile con tutte le pilette standard da 3,5"	<b>80</b>



NEW

CODICE	MISURA	DESCRIZIONE	€ iva esclusa
<b>KITPVD2G</b>	ø 90 mm	Piletta a due vie, 1 griglia troppopieno rettangolare, 1 griglia troppopieno rotonda, in PVD color oro. Può essere richiesto anche successivamente all'ordine del lavello. Compatibile con tutte le pilette standard da 3,5"	<b>135</b>

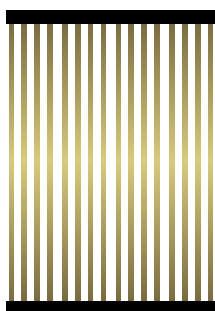

CODICE	MISURA	DESCRIZIONE	€ iva esclusa
<b>ROLLMAT-GO</b>	442X316	Gocciolatoio pieghevole in silicone e acciaio inox, color oro (GOLD)	<b>125</b>

## ACCESSORI COORDINATI - RAME

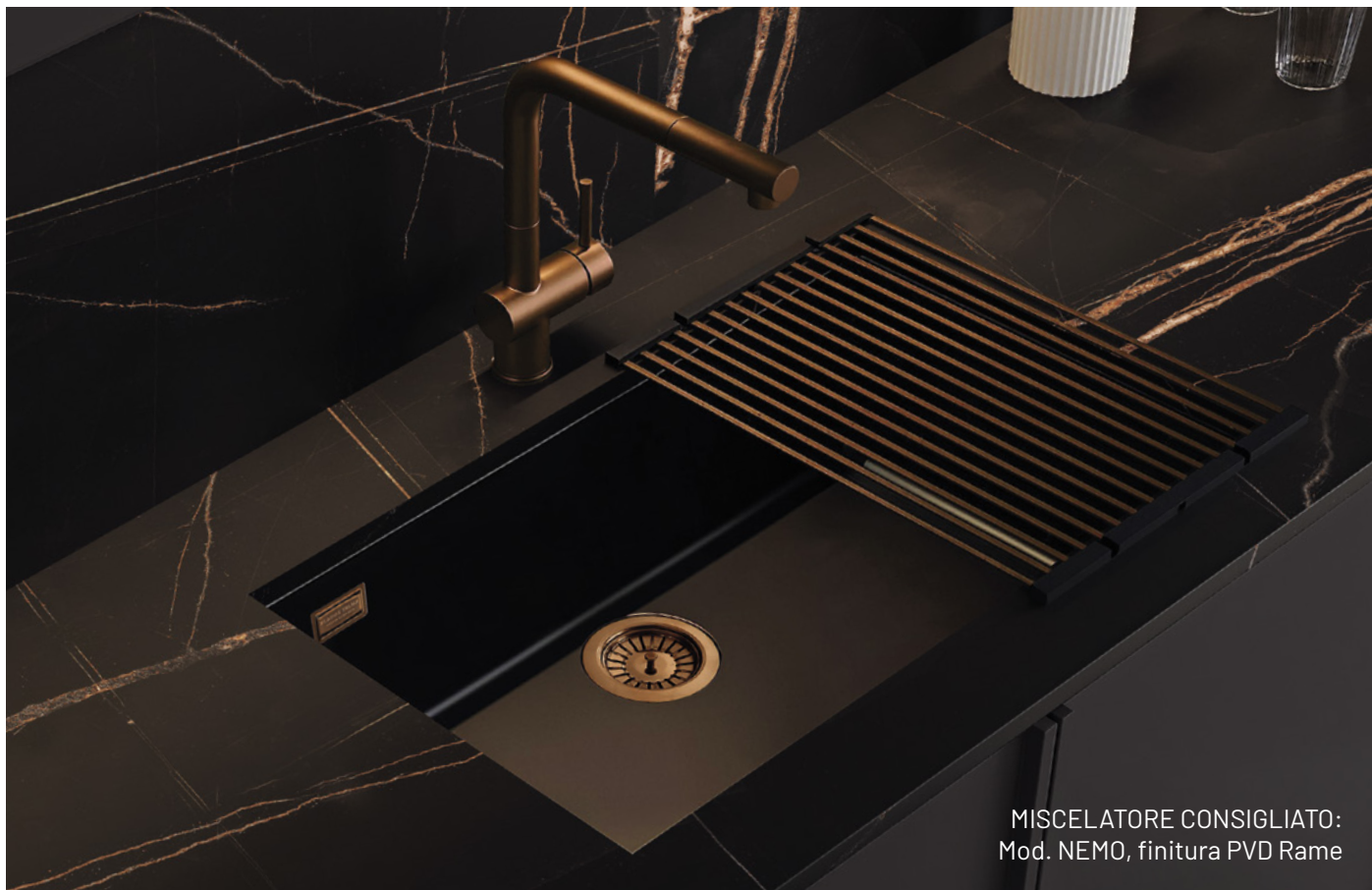

CODICE	MISURA	DESCRIZIONE	€ iva esclusa
<b>KITPVD1C</b>	ø 90 mm	Piletta a una via, 1 griglia troppopieno rettangolare, 1 griglia troppopieno rotonda, in PVD color rame. Può essere richiesto anche successivamente all'ordine del lavello. Compatibile con tutte le pilette standard da 3,5"	<b>80</b>



CODICE	MISURA	DESCRIZIONE	€ iva esclusa
<b>KITPVD2C</b>	ø 90 mm	Piletta a due vie, 1 griglia troppopieno rettangolare, 1 griglia troppopieno rotonda, in PVD color rame. Può essere richiesto anche successivamente all'ordine del lavello. Compatibile con tutte le pilette standard da 3,5"	<b>135</b>

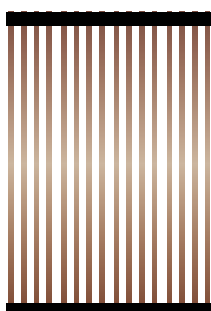

CODICE	MISURA	DESCRIZIONE	€ iva esclusa
<b>ROLLMAT-CO</b>	442X316	Gocciolatoio pieghevole in silicone e acciaio inox, color rame (COPPER)	<b>125</b>



PLADOS  
TELMA

PLADOS TELMA

# ACCESSORI COORDINATI - TOTAL BLACK



MISCELATORE CONSIGLIATO:  
Mod. NEMO, finitura N6 Deep Black



CODICE	MISURA	DESCRIZIONE	€ iva esclusa
<b>KITBLACK1</b>	ø 90 mm	Kit composto da piattino copri-piletta e piletta, troppopieno rotondo e rettangolare, in ABS nero. Può essere richiesto anche successivamente all'ordine del lavello. Compatibile con tutte le pilette di scarico standard da 3,5".	<b>120</b>



CODICE	MISURA	DESCRIZIONE	€ iva esclusa
<b>KITBLACK2</b>	ø 90 mm	Kit composto da piattino copri-piletta e piletta, troppopieno rotondo e rettangolare, in ABS nero. Può essere richiesto anche successivamente all'ordine del lavello. Compatibile con tutte le pilette di scarico standard da 3,5".	<b>175</b>

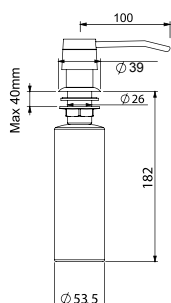

CODICE	MISURA	DESCRIZIONE	COLORI DISPONIBILI	€ iva esclusa
<b>DISP-70</b>	ø 26 mm	Dispenser per sapone liquido. Per tutti i modelli dove è possibile l'inserimento. Vedi prefori sotto il lavello.	• DISP/70 Nero Matt	<b>78</b>

# ROLLMAT

Il gocciolatoio pieghevole ROLLMAT è dotato di barre in acciaio inox a sezione quadrata per garantire una maggiore stabilità agli oggetti che vi poggiano. Può essere utilizzato anche piegato, riducendo così l'ingombro e aumentando la stabilità. Adatto per modelli da incasso e sottotop, ROLLMAT è disponibile in 4 raffinati colori per abbinarsi nel modo migliore allo stile della cucina:

- Inox
- Black
- Copper
- Gold

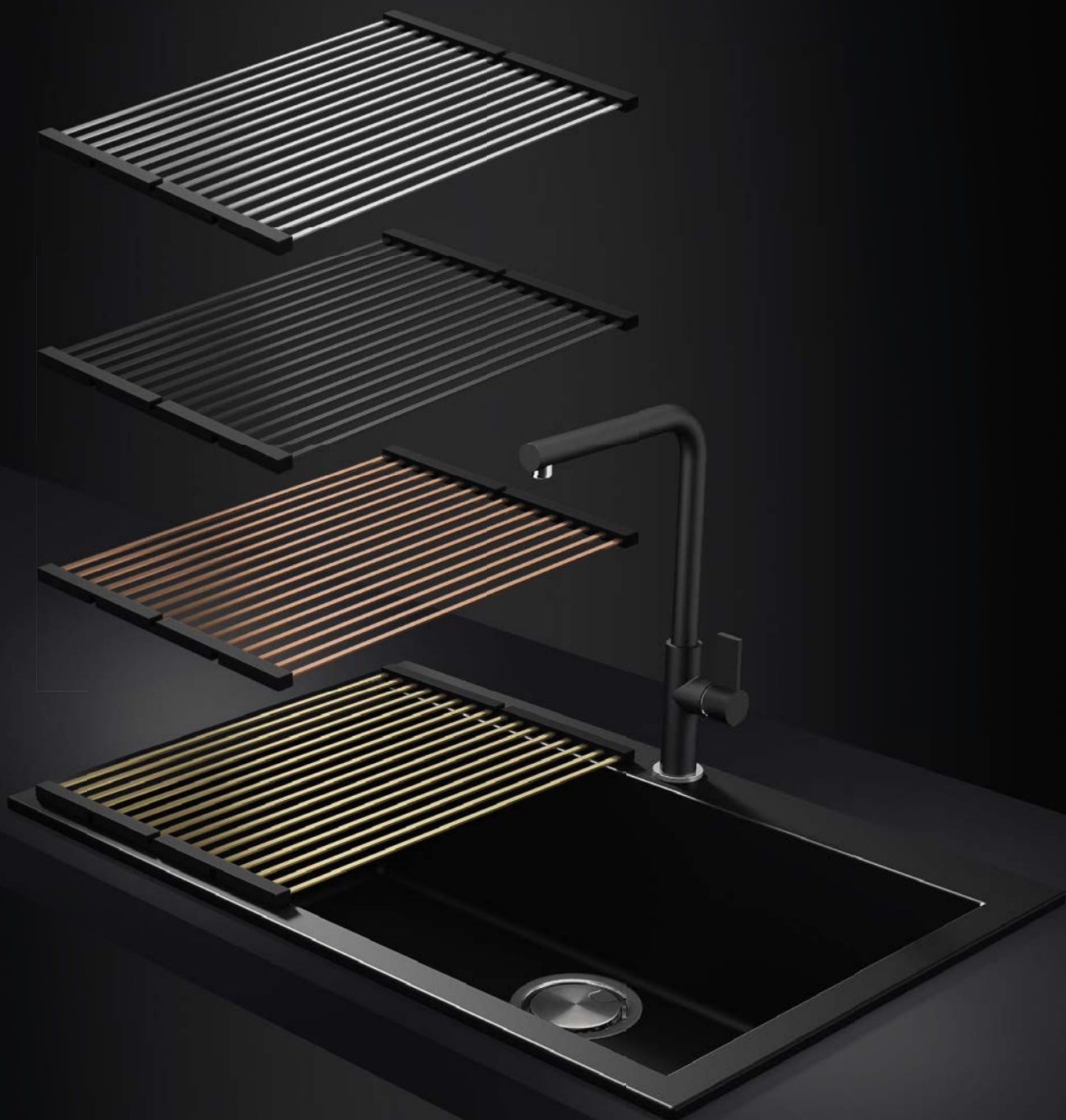

# ACCESSORI DESIGN

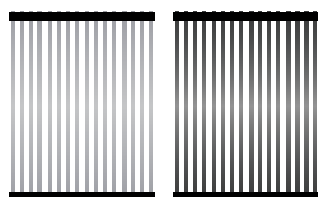

INOX

GUN METAL

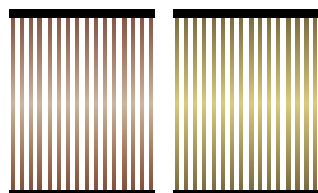

COPPER

GOLD

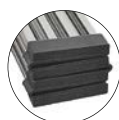

Pieghevole

CODICE	MISURA	DESCRIZIONE	€ iva esclusa
<b>ROLLMAT</b>	442X316	Gocciolatoio pieghevole in silicone e acciaio inox, universale. Colori disponibili: • IX - Inox • BL - Gun Metal • CO - Copper • GO - Gold	<b>125</b>

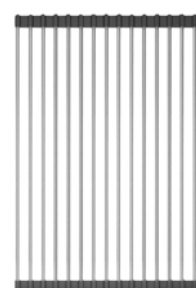

Avvolgibile

CODICE	MISURA	DESCRIZIONE	€ iva esclusa
<b>ROLLUP</b>	315X454	Gocciolatoio avvolgibile in silicone e acciaio inox, universale.	<b>95</b>

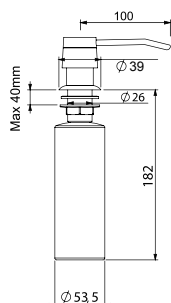

CODICE	MISURA	DESCRIZIONE	COLORI DISPONIBILI	€ iva esclusa
<b>DISP</b>	Ø 26 mm	Dispenser per sapone liquido. Per tutti i modelli dove è possibile l'inserimento. Vedi prefori sotto il lavello.	• DISP/40 Cromo	<b>53</b>
			• DISP/70 Nero Matt	<b>78</b>



CODICE	MISURA	DESCRIZIONE	€ iva esclusa
<b>COVERIX</b>	Ø 90 mm	Piattino copri-piletta in acciaio inox con finitura satinata. La piletta standard in acciaio inox è inclusa in ogni lavello. Può essere richiesto anche successivamente all'ordine del lavello. Compatibile con tutte le pilette di scarico standard da 3,5".	<b>23</b>



CODICE	MISURA	DESCRIZIONE	€ iva esclusa
<b>COPPILT10</b>	Ø 90 mm	Kit composto da un cestello più un copri-piletta. Può essere richiesto anche successivamente all'ordine del lavello. Compatibile con tutte le pilette di scarico standard da 3,5".	<b>30</b>



CODICE	MISURA	DESCRIZIONE	€ iva esclusa
<b>CTPC10P</b>		Clip removibile copri-troppo pieno. Non impedisce il deflusso. Compatibile con il troppo pieno rotondo standard.	<b>23</b>

# TAGLIERI

IN LEGNO IROKO



CODICE	MISURA	DESCRIZIONE	€ iva esclusa
<b>MULTIRACK</b>	423X200	Piano ausiliario scorrevole con due contenitori in acciaio inox per posate o utensili. Per CT9010.	<b>130</b>



CODICE	MISURA	DESCRIZIONE	€ iva esclusa
<b>TAGL88</b>	534X280	Tagliere universale a scorrimento esterno, per tutti i lavelli rettangolari eccetto serie ONE sotto-top e serie ONE integrata.	<b>110</b>



CODICE	MISURA	DESCRIZIONE	€ iva esclusa
<b>PLTAGIRK</b>	425X376	Per modelli ATLANTIC PL1162, PL0862, PL0861.	<b>110</b>



CODICE	MISURA	DESCRIZIONE	€ iva esclusa
<b>TAGL44</b>	413X250	Per modello ELEGANCE AM8620 e per serie ONE eccetto ON8620	<b>110</b>



CODICE	MISURA	DESCRIZIONE	€ iva esclusa
<b>TAGIRK1</b>	467X439	Per modello HR0860	<b>110</b>



# TAGLIERI

IN POLIETILENE E CRISTALLO

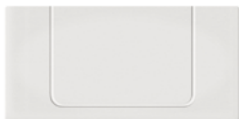

CODICE	MISURA	DESCRIZIONE	€ iva esclusa
<b>TAGP66</b>	534X260	Tagliere universale a scorrimento esterno, per tutti i livelli rettangolari eccetto serie ONE sotto-top e serie ONE integrata.	<b>110</b>



CODICE	MISURA	DESCRIZIONE	€ iva esclusa
<b>PLTAGPOL</b>	425X376	Per modelli ATLANTIC PL1162, PL0862, PL0861.	<b>110</b>

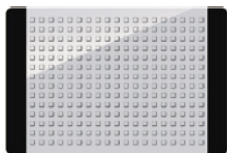

CODICE	MISURA	DESCRIZIONE	€ iva esclusa
<b>TAGCR</b>	479X271	Tagliere in cristallo trasparente con serigrafia sul lato posteriore. Per tutti i modelli rettangolari eccetto HR0860, HR0862, HR0792, Serie Roxana, Serie ONE.	<b>75</b>



CODICE	MISURA	DESCRIZIONE	€ iva esclusa
<b>ONTAGCR</b>	412X270	Tagliere in cristallo, smerigliato sul lato posteriore. Per serie ONE eccetto ON8420, ON8410, ON8620, ON8420ST, ON8410ST, ON8620ST.	<b>95</b>



CODICE	MISURA	DESCRIZIONE	€ iva esclusa
<b>TAGCRLUX</b>	405X430	Tagliere in cristallo per LX8620	

- Colori disponibili:
- TAGCRLUX/K1 - Cristallo Bianco **95**
  - TAGCRLUX/K2 - Cristallo Nero **95**

**ATTENZIONE! Il codice TAGCRLUX... si riferisce al singolo tagliere in cristallo e non alla coppia.**

# VASCHE E CESTELLI

IN ACCIAIO INOX E POLICARBONATO



CODICE	MISURA	DESCRIZIONE	€ iva esclusa
<b>LXVASINX</b>	392X169	Vaschetta in acciaio inox per modello LX8620	<b>155</b>
<b>ONVASINX</b>	424x167	Vaschetta in acciaio inox per AM8620, e per le serie ONE eccetto ON8620.	<b>155</b>



CODICE	MISURA	DESCRIZIONE	€ iva esclusa
<b>SPCESINX</b>	385X315	Cestello rettangolare per tutti modelli eccetto HR0860 e lavelli tondi.	<b>125</b>



CODICE	MISURA	DESCRIZIONE	€ iva esclusa
<b>VAS70LX</b>	401x180	Vaschetta in policarbonato nero per LX8620 e LX8610.	<b>85</b>
<b>VAS70ON</b>	423X180	Vaschetta in policarbonato nero per LX8410, ON7610, ON7920, ON6910, ON6010, ON5610 AM8620, e relative versioni sottotop.	<b>85</b>



CODICE	MISURA	DESCRIZIONE	€ iva esclusa
<b>SPVASPOL</b>	297x160	Vaschetta in policarbonato trasparente per i modelli: Elegance AM7815 Corax CX0991;	<b>35</b>

# TRITARIFIUTI

## I DISSIPATORI PLADOS ELIMINANO I RIFIUTI ALIMENTARI IN MODO COMODO, PRATICO E SICURO.

I rifiuti depositati in pattumiera causano spesso disordine, sporcizia e cattivi odori, attirando talvolta fastidiosi insetti. L'utilizzo del tritarifiuti consente di eliminare questo genere di inconvenienti facilitando il lavoro domestico. Un aiuto indispensabile per mantenere ordine ed igiene in cucina.

**RIFIUTI ALIMENTARI SMALTIBILI:** frutta, verdura, lische di pesce, piccole ossa, pasta, gusci d'uovo, noci, etc...



**PULSANTE IN ABS  
CROMATO DI SERIE**



### TBG05

- 1/2 HP
- 380 W
- 220-240 V / 50 Hz
- Isolamento acustico standard
- Peso kg 6,5
- Dimensioni 182x327 mm
- Capacità ml 1.200
- Motore ad induzione

€ iva esclusa

**570**



**PULSANTE IN ABS  
CROMATO DI SERIE**



### TBG075

- 3/4 HP
- 600 W
- 220-240 V / 50 Hz
- Isolamento acustico **plus**
- Peso kg 8,5
- Dimensioni 182x327 mm
- Capacità ml 1.200
- Motore ad induzione
- **Doppio sistema di triturazione**
- **Rotore maggiorato**

€ iva esclusa

**870**

# MANUTENZIONE

## E PULIZIA



### BRILLCARE

500 ml - BRILLCARE è un detergente a base d'acqua, formulato con agenti di **derivazione vegetale velocemente biodegradabili**, riconosciuti e certificati **ECOLABEL**. È ideale per la pulizia quotidiana dei **lavelli e di tutte le superfici lavabili della cucina**. BRILLCARE rispetta le superfici e non lascia aloni.

€ iva esclusa

40



### EXTRACARE

500 ml - EXTRACARE è un detergente smacchiante per le pulizie straordinarie. Attivo contro lo sporco più ostinato, è stato studiato **per smacchiare senza danneggiare il colore e la lucentezza dei lavelli in materiale composito**. Grazie alla sua formulazione densa è indicato anche per l'applicazione in verticale. La lenta asciugatura permette agli agenti attivi di reagire per il maggior tempo possibile. È molto facile da applicare e non lascia aloni. L'ideale è utilizzare Extracare dopo aver eliminato il calcare con DeKal.

€ iva esclusa

40



### MULTICARE

250 ml - MULTICARE è un detergente multisuperficie. Formulato con agenti di derivazione vegetale velocemente biodegradabili, riconosciuti e certificati **ECOLABEL**, è ideale **per la pulizia di lavelli in acciaio inox, rubinetti colorati e piani cottura smaltati**. MULTICARE rispetta le superfici e non lascia aloni.

€ iva esclusa

38



### DEKAL

250 ml - DEKAL è un anticalcare studiato per i lavelli Plados che **elimina il calcare senza danneggiare la lucentezza del materiale composito**. Sugeriamo di effettuare la decalcificazione una volta a settimana. In caso di macchie ostinate, dopo aver eliminato il calcare con DEKAL, si può utilizzare lo smacchiatore EXTRACARE.

€ iva esclusa

50



### ECOSPONGE

Due spugne doppia azione in cellulosa di origine vegetale e **100% biodegradabile**. Il lato in cellulosa di origine vegetale è super assorbente, ideale **per pulire con delicatezza**, mentre il lato in fibra **pulisce le superfici incrostate senza graffiare**. I lati rinforzati garantiscono lunga durata e l'alto spessore un'efficace protezione delle dita. Multiuso, ideale per tutti i prodotti Plados in cucina.

€ iva esclusa

28

## ALTRI ACCESSORI



CODICE	MISURA	DESCRIZIONE	€ iva esclusa
PILAV1	ø 90 mm	Scarico automatico 1 via	45
PILAV2	ø 90 mm	Scarico automatico 2 vie	75



CODICE	MISURA	DESCRIZIONE	€ iva esclusa
GANCIST06		Kit 6 ganci per il montaggio sotto-top.	30



KITFRESA

FRESA

CODICE	MISURA	DESCRIZIONE	€ iva esclusa
KITFRESA		Kit per foratura del lavello, composto da codolo + fresa diamantata ø 35-37mm	175
FRESA		Fresa diamantata ø 35-37mm	125

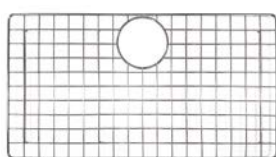

CODICE	MISURA	DESCRIZIONE	€ iva esclusa
GRID76	630X340	Griglia fondo vasca per ON7610.	135
GRID84	680X360	Griglia fondo vasca per ON8410.	155

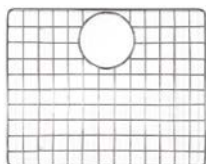

CODICE	MISURA	DESCRIZIONE	€ iva esclusa
GRID60	425X340	Griglia fondo vasca per ON6010, ON5610.	105

## CORRETTA PROCEDURA PER LA FORATURA DEI LAVELLI

Tutti i lavelli Plados sono provvisti di prefiori per il montaggio della rubinetteria. In alcuni modelli sono presenti più prefiori (**fig. A**) per cui l'installatore può decidere dove posizionare il rubinetto. **ATTENZIONE:** Per evitare rotture del lavello, il completamento del foro va effettuato solo ed esclusivamente con una fresa Ø35-37 mm, seguendo le indicazioni mostrate nelle figure B e C. Plados può fornire sia il **kit completo** per la foratura del lavello composto da **Codolo + Fresa (code KITFRESA)**, sia la **fresa diamantata di ricambio (code FRESA)**, vedi accessori nella pagina.



VIDEO TUTORIAL



**A** - Prefiori presenti nei lavelli Plados



**B** - Posizionare la fresa in corrispondenza del prefioro



**C** - Procedere con il completamento del foro



# MISCELATORI



<b>3 e 4 VIE</b>	<b>186</b>
<b>SISTEMA FILTRANTE</b>	<b>189</b>
<b>POLYTECH</b>	<b>190</b>
<b>PROFESSIONAL</b>	<b>192</b>
<b>ELEGANT</b>	<b>196</b>
<b>DESIGN</b>	<b>202</b>
<b>BASIC</b>	<b>212</b>
<b>SOTTO-FINESTRA</b>	<b>216</b>
<b>ANTICATI</b>	<b>218</b>

I miscelatori Plados hanno un funzionamento ottimale se sono soddisfatte le seguenti condizioni:

- Pressione di esercizio: 1,5-5 bar
- Temperatura max: 80° C

Qualora si riscontrasse una pressione superiore a 5 bar, è consigliabile installare un riduttore di pressione. Granelli di sabbia o altre impurità, sempre presenti nell'acqua, possono danneggiare la cartuccia miscelatrice o le guarnizioni di tenuta, provocando perdite nel miscelatore. L'installazione, a monte dello stesso, di una coppia di rubinetti di arresto con filtro ispezionabile nei due flessibili di adduzione dell'acqua calda e dell'acqua fredda, preserva il miscelatore da detti inconvenienti.



ITALIAN  
TECHNOLOGY

# ROTAZIONE LEVA A 90°



Il risparmio passa anche dai piccoli dettagli: Le nuove cartucce dei miscelatori Plados hanno una rotazione di 90°. La leva ruota solo in avanti e ciò, oltre a consentire l'installazione del miscelatore in spazi limitati o in prossimità della parete posteriore, permette di evitare inutili accensioni della caldaia contribuendo così ad un notevole risparmio energetico.





GREENPEACE STIMA CHE, MEDIAMENTE, OGNI ITALIANO CONSUMA  
QUATTORDICI BOTTIGLIE DI PLASTICA AL MESE.

MOLTIPLICATE PER IL NUMERO DI ABITANTI E PER DODICI MESI, FANNO

**10.000.000.000**  
DI BOTTIGLIE DI PLASTICA ALL'ANNO.

Fonte: articolo del 1/07/2021,  
"L'insostenibile peso delle bottiglie di plastica"  
[www.greenpeace.org](http://www.greenpeace.org)

**Scegliere un sistema per l'acqua filtrata significa:**

- Salvaguardare l'ambiente riducendo il consumo di plastica;
- Risparmiare fatica, tempo e denaro sull'acquisto e il trasporto di pesanti bottiglie, che andranno poi smaltite;
- Benefici per la salute grazie a una migliore qualità dell'acqua.

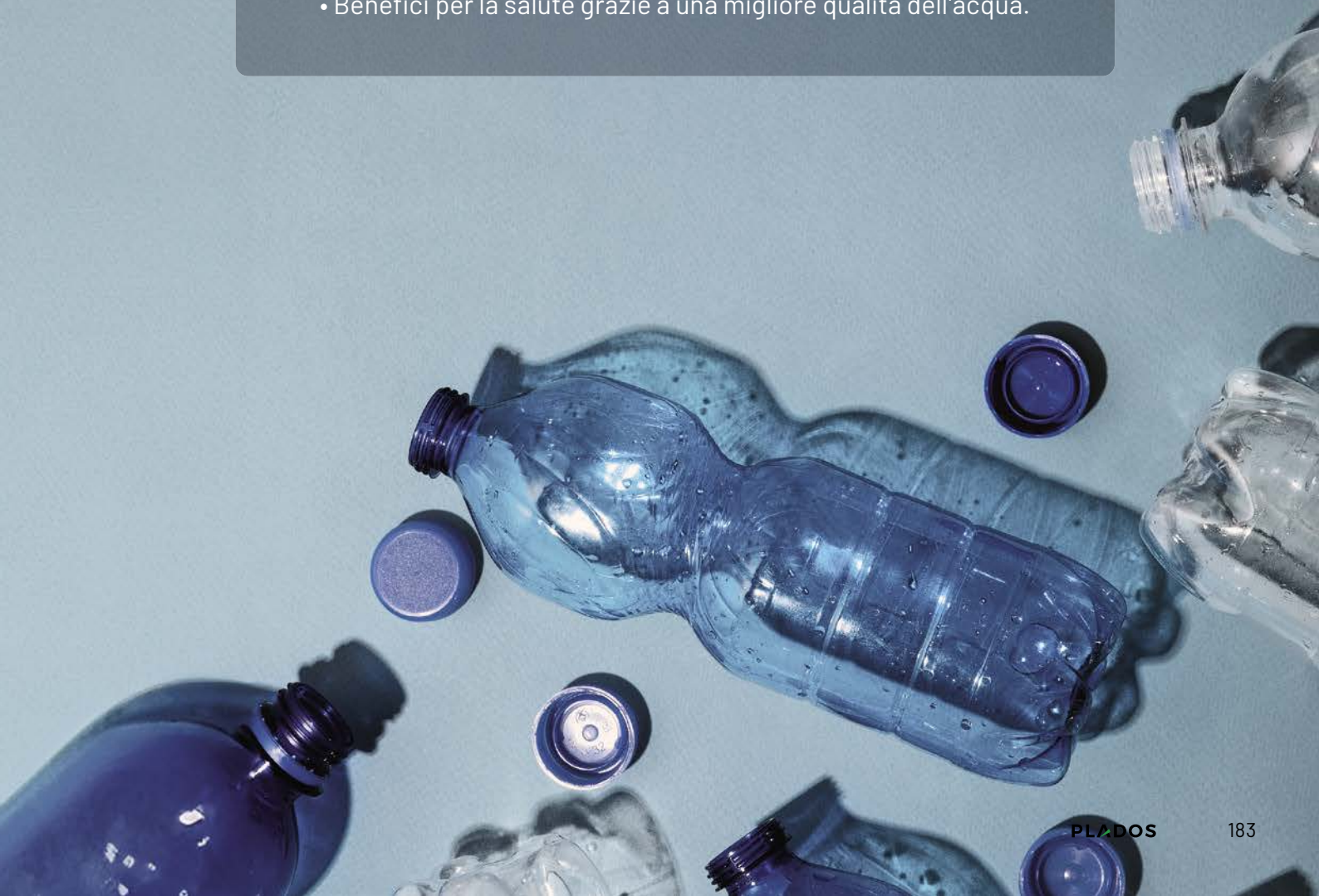

# MISCELATORI/TRIFLOW

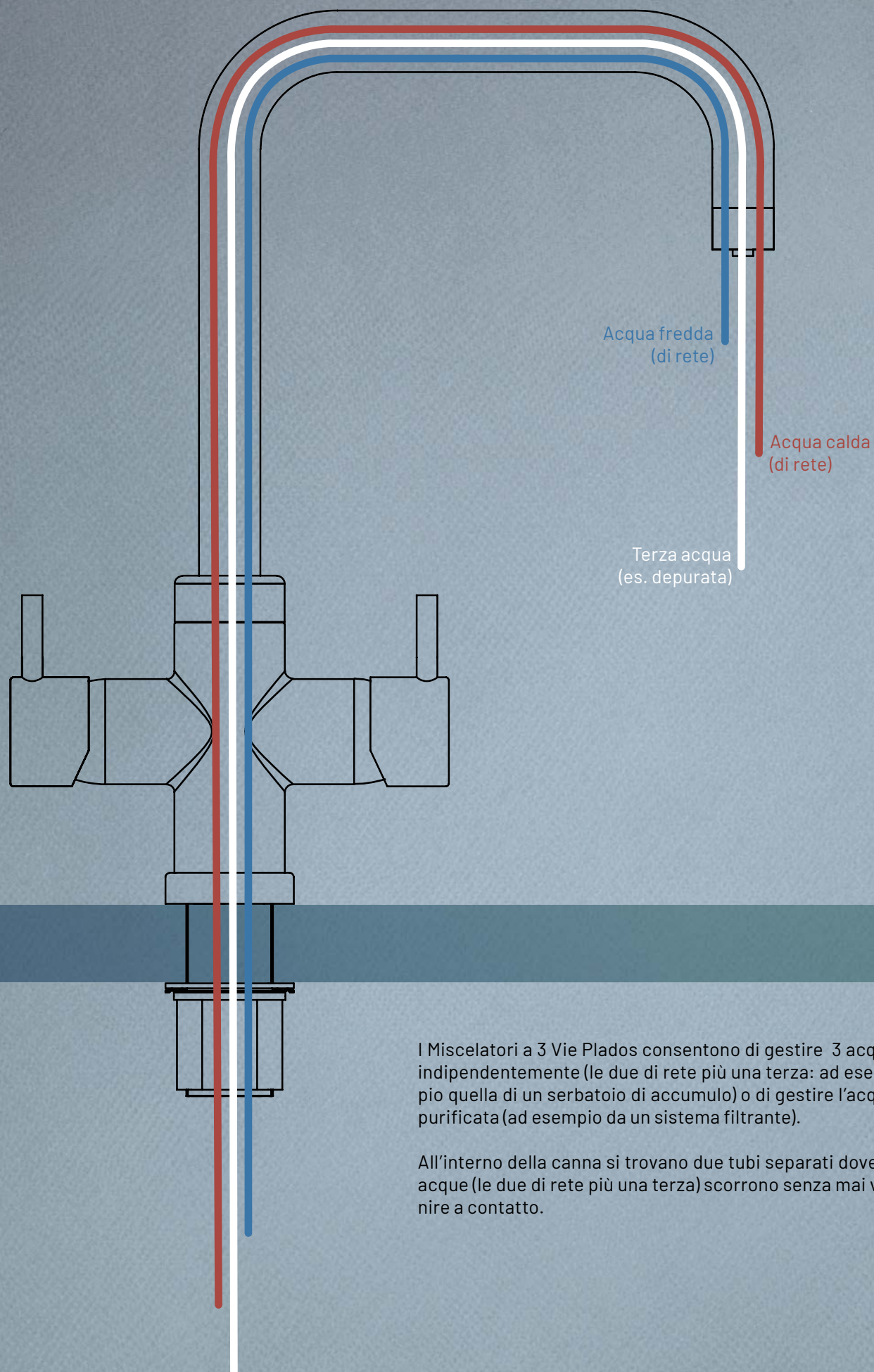

I Miscelatori a 3 Vie Plados consentono di gestire 3 acque indipendentemente (le due di rete più una terza: ad esempio quella di un serbatoio di accumulo) o di gestire l'acqua purificata (ad esempio da un sistema filtrante).

All'interno della canna si trovano due tubi separati dove le acque (le due di rete più una terza) scorrono senza mai venire a contatto.

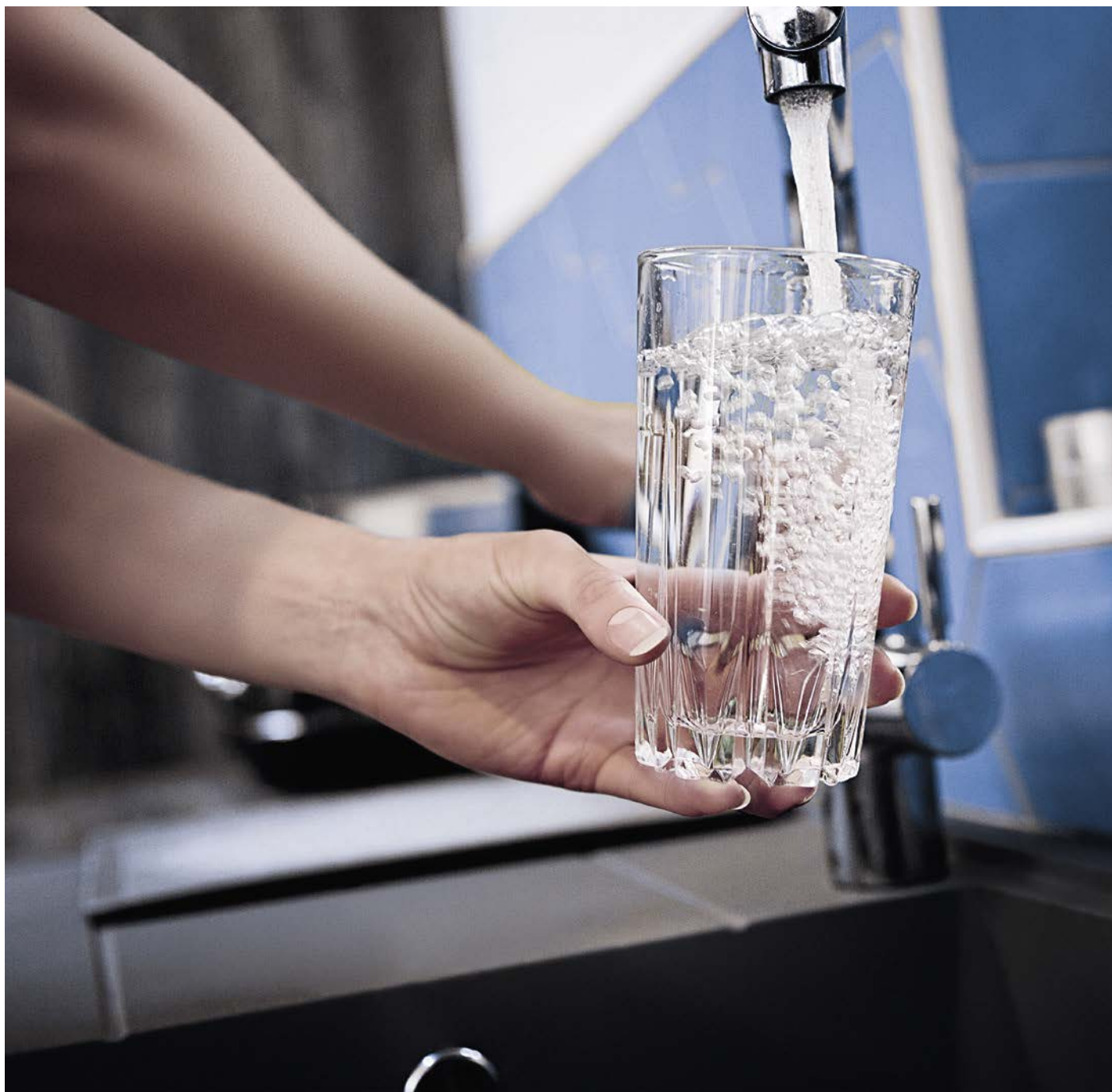

A differenza dei miscelatori di altri fabbricanti, il corpo interno dei miscelatori a tre vie Plados è realizzato in **tecnopolimeri** certificati per il contatto con alimenti, mentre il tubo di erogazione dell'acqua depurata è in **acciaio inox o in polietilene**, anziché in ottone: per la salute dei consumatori ciò rappresenta un enorme salto di qualità perché è noto a tutti che l'ottone al passaggio dell'acqua corrente rilascia metalli pesanti quali piombo, nickel e rame, tutti elementi molto dannosi per la salute. Oltre a ciò, i miscelatori sono dotati di una sofisticata **guarnizione a doppio labbro** che assicura una maggiore tenuta anche in presenza di acque particolarmente calcaree e aggressive.



# SORGENTE - 4 in 1



**ACQUA PURA, FRIZZANTE O NATURALE, DIRETTAMENTE DAL RUBINETTO.**

**SORGENTE 4 in 1** è un sistema innovativo che permette di avere acqua fresca, pura, gassata o naturale, direttamente dal rubinetto di casa.

Un'alternativa semplice ed economica all'acquisto di acqua in bottiglia. È composto da un filtro che depuratore, una bomboletta di anidride carbonica per produrre acqua gassata, e un chiller per il raffreddamento dell'acqua, sia naturale che gassata.

L'impianto ha dimensioni ridotte per poter essere installato sotto il lavandino della cucina.

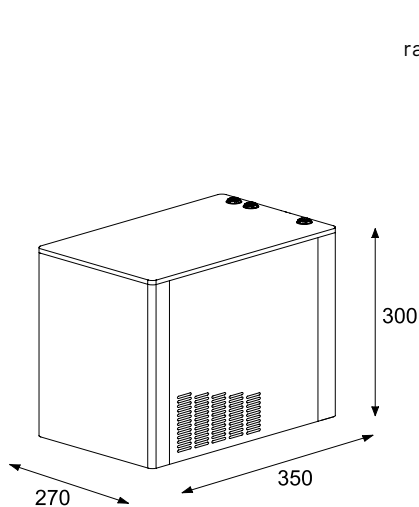
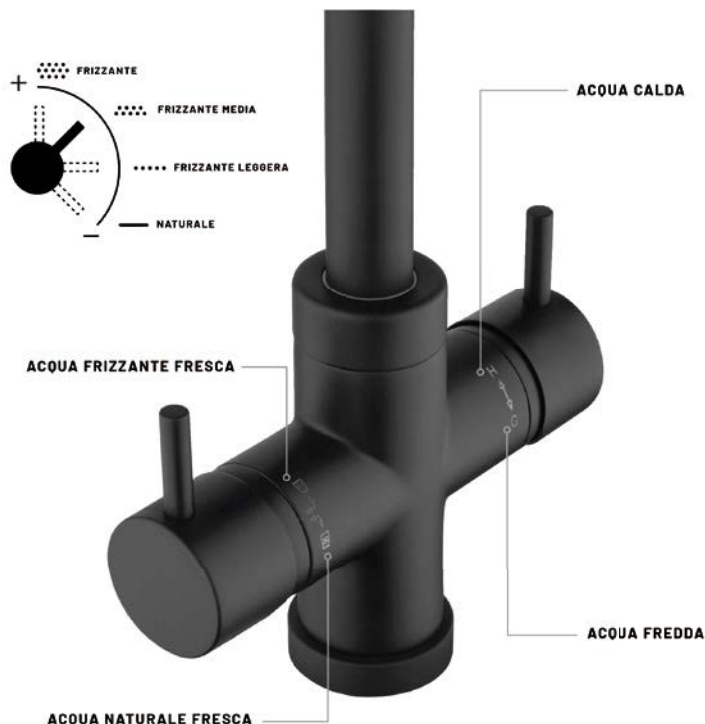

Chiller per il raffreddamento dell'acqua.



Cartuccia CO2 per acqua gassata.

Cartuccia depuratrice

## DATI TECNICI

Telaio	Acciaio al carbonio zincato verniciato a polvere
Alimentazione	220-230 Vac 50-60Hz
Compressore	1/8HP con protezione termica e condensatore di spunto
Capacità refrigerante	180W 155Kcal/h
Gas refrigerante	R134a
Condensazione	Acqua
Acqua prodotta	Acqua Naturale, Refrigerata, Gasata Refrigerata
Capacità di erogazione acqua refrigerata	20Lt/h*
Capacità di erogazione acqua gassata	2Lt/m
Saturatore e refrigeratore	3Lt in AISI304
Gruppo di pressurizzazione	5,6 Lt/m PSI

## FUNZIONI

- Regolazione temperatura refrigeratore regolabile con sonda di temperatura;
- Regolazione fermata minima sistema di refrigerazione;
- Tempo massimo di funzionamento in continuo;
- Tempo stop forzato;
- Time-Out riempimento tank refrigerato;
- Display;
- Erogazione mediate rubinetto esterno;

## SORGENTE1

Miscelatore a 4 vie, con depuratore, refrigeratore e gasatore.



- Cartuccia a dischi ceramici
- Rotazione canna: 180°
- Foro sul lavello: Ø35 mm
- Flessibili di allacciamento in acciaio inox, L=35 cm
- Diametro base: 50 mm

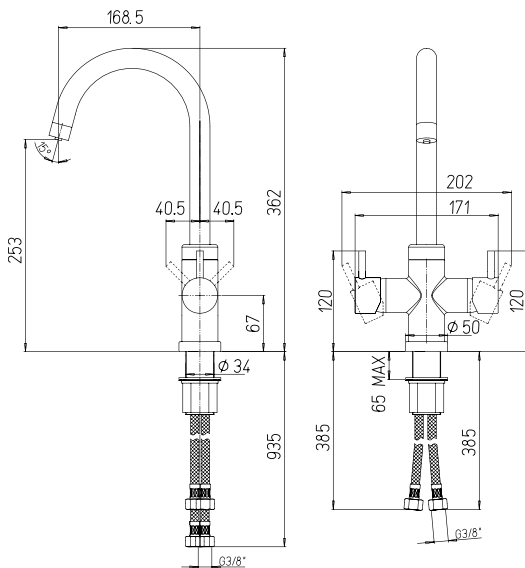

€ IVA esclusa

40 CROMO  
**SORGENTE1 / 40** **4.550**

MICROULTRAGRANIT € IVA esclusa

UG 70 NERO MATT  
**SORGENTE1 / 70** **4.550**

## SORGENTE2

Miscelatore a 4 vie, con depuratore, refrigeratore e gasatore.



- Cartuccia a dischi ceramici
- Rotazione canna: 180°
- Foro sul lavello: Ø35 mm
- Flessibili di allacciamento in acciaio inox, L=35 cm
- Diametro base: 50 mm

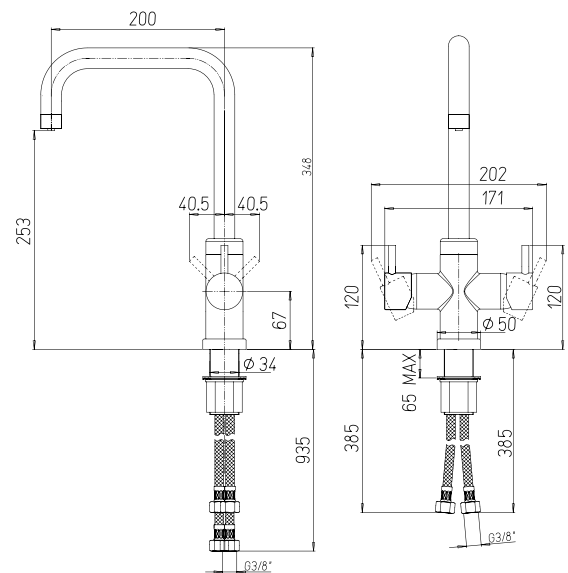

€ IVA esclusa

40 CROMO  
**SORGENTE2 / 40** **4.550**

MICROULTRAGRANIT € IVA esclusa

UG 70 NERO MATT  
**SORGENTE2 / 70** **4.550**

## FL055

Miscelatore monocomando a 3 vie,  
comando terza acqua indipendente.



NEW

- Cartuccia a dischi ceramici speciale per 3 vie, Ø40 mm (bassa)
- Vitone ceramico 90° sinistro
- Rotazione canna: 180°
- Foro sul lavello: Ø35 mm
- Flessibili di allacciamento in acciaio inox, L=35 cm
- Diametro base: 58 mm

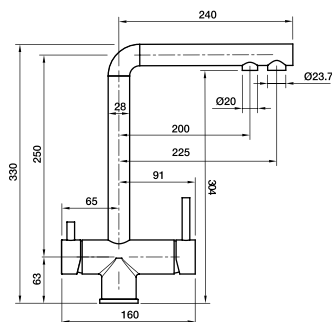

€ IVA esclusa

40 CROMO  
FL055 / 40 **410**

MICROULTRAGRANIT € IVA esclusa

UG 70 NERO MATT  
FL055 / 70

UG 72 TARTUFO  
FL055 / 72

UG 94 AVENA  
FL055 / 94

UG 98 BIANCO  
FL055 / 98

**450**

ULTRAMETAL € IVA esclusa

UM 41 ALLUMINIO  
FL055 / 41

UM 42 TITANIO  
FL055 / 42

UM 44 NERO  
FL055 / 44

**470**

## FL060

Miscelatore monocomando a 3 vie,  
comando terza acqua indipendente.



NEW

- Cartuccia a dischi ceramici speciale per 3 vie, Ø35 mm (bassa)
- Vitone ceramico 90° sinistro
- Rotazione canna: 180°
- Foro sul lavello: Ø35 mm
- Flessibili di allacciamento in acciaio inox, L=35 cm
- Diametro base: 50 mm

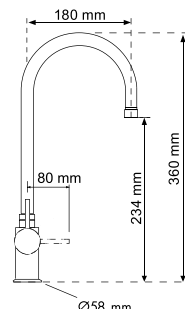

€ IVA esclusa

40 CROMO  
FL060 / 40 **410**

MICROULTRAGRANIT € IVA esclusa

UG 70 NERO MATT  
FL060 / 70

UG 72 TARTUFO  
FL060 / 72

UG 94 AVENA  
FL060 / 94

UG 98 BIANCO  
FL060 / 98

**450**

ULTRAMETAL € IVA esclusa

UM 41 ALLUMINIO  
FL060 / 41

UM 42 TITANIO  
FL060 / 42

UM 44 NERO  
FL060 / 44

**470**

A differenza dei miscelatori di altri fabbricanti, il corpo interno dei miscelatori a tre vie Plados è realizzato in **tecnopolimeri** certificati per il contatto con alimenti, mentre il tubo di erogazione dell'acqua depurata è in **acciaio inox o in polietilene**, anziché in ottone: per la salute dei consumatori ciò rappresenta un enorme salto di qualità perché è noto a tutti che l'ottone al passaggio dell'acqua corrente rilascia metalli pesanti quali piombo, nickel e rame, tutti elementi molto dannosi per la salute. Oltre a ciò, i miscelatori sono dotati di una sofisticata **guarnizione a doppio labbro** che assicura una maggiore tenuta anche in presenza di acque particolarmente calcaree e aggressive.

# SISTEMA FILTRANTE



Il sistema filtrante a carbone attivo vegetale è il complemento ideale per i rubinetti a tre vie in grado di erogare acque separate. Il carbone attivo è in grado di filtrare impurità fino a 5 micron, esercitando anche un'azione batteriostatica. Agenti inquinanti, cloro, odori indesiderati, fibre di amianto, muffe, alghe e cisti protozoarie, vengono trattenuti dal filtro, generando acqua priva di sostanze nocive e pronta da bere.

## VANTAGGI DEL SISTEMA FILTRANTE A CARBONE ATTIVO:

- **Salvaguarda l'ambiente** riducendo il consumo di bottiglie di plastica;
- **Risparmia fatica, tempo e denaro**, eliminando acquisto e trasporto di pesanti bottiglie che andranno poi smaltite;
- Installazione o sostituzione del filtro semplici e veloci, **non richiedono intervento tecnico**;
- Il filtro assicura sempre **acqua di qualità**, riducendo automaticamente il flusso d'acqua quando è saturo.
- **Ingresso minimo** in quanto il sistema occupa pochissimo spazio e può essere installato nel sottolavabo.

€ iva esclusa



## KITFIL - Kit di installazione

- Testata filtro
- Raccordi
- Tubi di installazione
- Rubinetto di arresto

205

€ iva esclusa



## FILCAR - Cartuccia filtrante

- |                                     |                                  |
|-------------------------------------|----------------------------------|
| • Composizione materiale filtrante: | Carbone attivo vegetale di cocco |
| • Composizione materiale filtro:    | Alluminio, 100% riciclabile      |
| • Composizione materiale testata:   | PVC, 100% riciclabile            |
| • Pressione di esercizio:           | Da 0,7 a 8 bar                   |
| • Temperatura di esercizio:         | Da 4 °C a 38°C                   |
| • Tipo di manutenzione:             | A perdere                        |
| • Disponibilità:                    | 10"/20"                          |
| • Grado di filtrazione:             | 5 micron                         |
| • Portata:                          | 1,9 L/min                        |
| • Quantità acqua erogata:           | 11.370 L                         |

180

## Dati acqua in ingresso:

- |               |          |
|---------------|----------|
| • Press. max: | 8 bar    |
| • Press. min: | 0,7 bar  |
| • Cloro max:  | 1,5 mg/L |
| • TDS:        | 2000 ppm |
| • Ferro:      | Assente  |
| • SDI:        | 5.0      |



Conforme al D.M. 25/2012 - Tutti i materiali sono atossici. Certificati di atossicità effettuati presso laboratorio specializzato, disponibili su richiesta. Le prestazioni del prodotto possono variare a seconda della portata e della qualità dell'acqua in ingresso. Si raccomanda di sostituire la cartuccia almeno una volta l'anno. L'apparecchio deve funzionare rigorosamente in posizione verticale.

# POLYTECH

## i rubinetti ecologici

- **Cartuccia + aeratore a risparmio idrico**
- **Installazione rapida SEMPLIFIX**
- **Corpo interno in teflon, senza piombo**
- **Atossici, anallergici, riciclabili**
- **Idonei al contatto con gli alimenti**

Costruiti con materiali ecologici e provvisti di speciali aeratori e cartucce per il risparmio idrico, atossici, riciclabili e idonei per il contatto con gli alimenti. Il corpo interno dei miscelatori POLYTECH è realizzato con innovativi tecnopolimeri che non contengono e non rilasciano nell'acqua metalli pesanti dannosi per la salute, come ad esempio piombo, nichel e rame. Grazie a questi tecnopolimeri, il calcare e le altre impurità presenti nell'acqua scivolano via, evitando progressivi accumuli che potrebbero favorire perdite e creare malfunzionamenti. Sono inoltre provvisti del sistema brevettato SEMPLIFIX® che consente l'installazione rapida dall'alto.



### CARTUCCIA SPECIALE A RISPARMIO IDRICO

La cartuccia a risparmio idrico può ridurre gli sprechi fino al 50%. Come? Aprendo la leva si incontra un blocco che limita la portata di acqua a circa 6 litri al minuto. Aprendo ulteriormente la leva si raggiunge l'erogazione standard di circa 12 litri al minuto, con una pressione media di 3 bar.

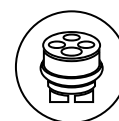
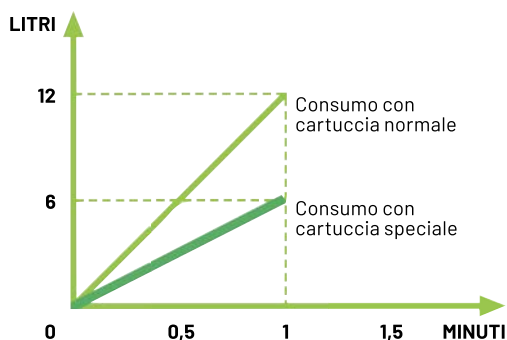
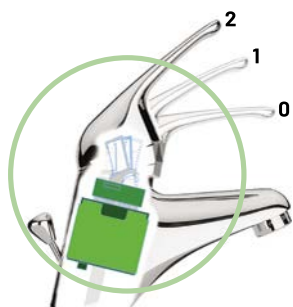

### MONTAGGIO RAPIDO DALL'ALTO

Il sistema brevettato SEMPLIFIX® rende facile e veloce sia l'installazione del rubinetto, sia la sostituzione nel tempo. Come mostrano le immagini, le 3 semplici fasi del montaggio avvengono dall'alto ed in pochi minuti, evitando all'installatore di operare in scomode e difficili posizioni.



Inserire dall'alto la base universale Simplifix nel foro del lavello.



Avvitare il blocco con la chiave in dotazione. La base è ora installata.



Fissare il rubinetto alla base con la seconda chiave in dotazione. **FATTO!**



## POLITEK10

Miscelatore monocomando con canna tubolare a ponte.



- Cartuccia a dischi ceramici Ø35 mm (bassa)
- Risparmio idrico tramite aeratore: 8,3 L/min
- Rotazione canna: 360°
- Foro sul lavello: Ø35 mm
- Flessibili di allacciamento in acciaio inox, L=35 cm
- Diametro base: 55 mm

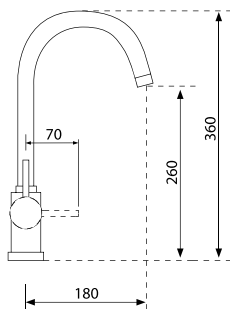

€ IVA esclusa

	40 CROMO POLITEK10 / 40	<b>180</b>
---	----------------------------	------------

**MICROULTRAGRANIT** € IVA esclusa

	UG 70 NERO MATT POLITEK10 / 70	
---	-----------------------------------	--

	UG 94 AVENA POLITEK10 / 94	<b>220</b>
---	-------------------------------	------------

	UG 98 BIANCO POLITEK10 / 98	
---	--------------------------------	--

**ULTRAMETAL** € IVA esclusa

	UM 41 ALLUMINIO POLITEK10 / 41	
---	-----------------------------------	--

	UM 42 TITANIO POLITEK10 / 42	<b>240</b>
---	---------------------------------	------------

	UM 44 NERO POLITEK10 / 44	
---	------------------------------	--



MONTAGGIO RAPIDO



CARTUCCIA SPECIALE RISPARMIO IDRICO

## POLITEK20

Miscelatore monocomando con canna a 90°.



- Cartuccia a dischi ceramici Ø35 mm (bassa)
- Risparmio idrico tramite aeratore: 8,3 L/min
- Rotazione canna: 360°
- Foro sul lavello: Ø35 mm
- Flessibili di allacciamento in acciaio inox, L=35 cm
- Diametro base: 55 mm

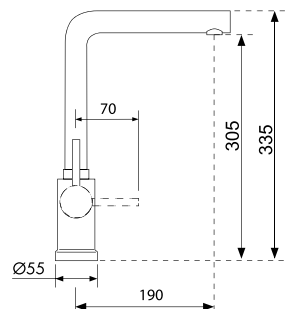

€ IVA esclusa

	40 CROMO POLITEK20 / 40	<b>210</b>
---	----------------------------	------------

**MICROULTRAGRANIT** € IVA esclusa

	UG 70 NERO MATT POLITEK20 / 70	
---	-----------------------------------	--

	UG 98 BIANCO POLITEK20 / 98	<b>250</b>
---	--------------------------------	------------

**ULTRAMETAL** € IVA esclusa

	UM 41 ALLUMINIO POLITEK20 / 41	
---	-----------------------------------	--

	UM 42 TITANIO POLITEK20 / 42	<b>270</b>
---	---------------------------------	------------

	UM 44 NERO POLITEK20 / 44	
---	------------------------------	--



MONTAGGIO RAPIDO



CARTUCCIA SPECIALE RISPARMIO IDRICO

## HEGO

Miscelatore monocomando con doccetta sganciabile a doppio getto, attacco doccia automatico.



- Cartuccia a dischi ceramici Ø25 mm (bassa)
- Rotazione canna: 360°
- Foro sul lavello: Ø35 mm
- Flessibili di allacciamento in acciaio inox, L=35 cm
- Diametro base: 52 mm

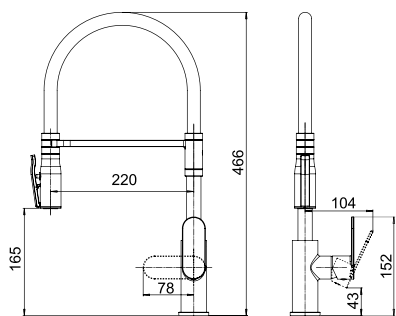

### MICROULTRAGRANIT

€ IVA esclusa



UG 70 NERO MATT  
HEGO / 70

**465**

### NANOSTONE

€ IVA esclusa



NS N6 DEEP BLACK  
HEGO / N6

**505**

## SHOWERMID

Miscelatore monocomando con doccetta sganciabile a doppio getto, attacco doccia automatico.



- Cartuccia a dischi ceramici Ø35 mm (bassa)
- Rotazione canna: 360°
- Foro sul lavello: Ø35 mm
- Flessibili di allacciamento in acciaio inox, L=35 cm
- Diametro base: 50 mm

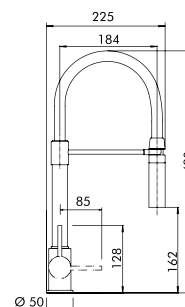

### MICROULTRAGRANIT

€ IVA esclusa



40 CROMO  
SHOWERMID / 40

**370**

### MICROULTRAGRANIT

€ IVA esclusa



UG 70 NERO MATT  
SHOWERMID / 70

**410**



## SPRINGP30

Miscelatore monocomando con doccetta sganciabile a doppio getto, attacco doccia automatico.



- Cartuccia a dischi ceramici Ø35 mm (bassa)
- Rotazione canna: 360°
- Foro sul lavello: Ø35 mm
- Flessibili di allacciamento in acciaio inox, L=35 cm
- Diametro base: 50 mm

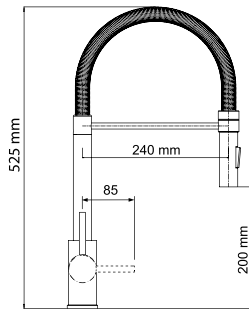

€ IVA esclusa

40 CROMO  
SPRINGP30 / 40 **365**

## SPRINGP40

Miscelatore monocomando con doccetta sganciabile a doppio getto, attacco doccia automatico.



- Cartuccia a dischi ceramici Ø35 mm (bassa)
- Rotazione canna: 360°
- Foro sul lavello: Ø35 mm
- Flessibili di allacciamento in acciaio inox, L=35 cm
- Diametro base: 45 mm

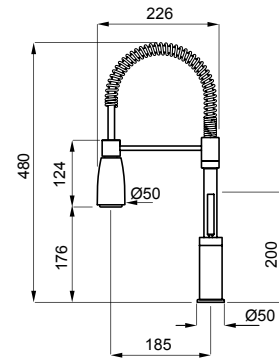

€ IVA esclusa

40 CROMO  
SPRINGP40 / 40 **410**

MICROULTRAGRANIT

€ IVA esclusa

UG 70 NERO MATT  
SPRINGP40 / 70 **450**



## NEWMIX80

Miscelatore monocomando  
con canna tubolare a ponte.



- Cartuccia a dischi ceramici Ø35 mm (bassa)
- Rotazione canna: 360°
- Foro sul lavello: Ø35 mm
- Flessibili di allacciamento in acciaio inox, L=35 cm
- Diametro base: 48 mm

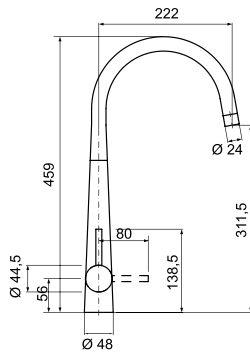

€ IVA esclusa

40 CROMO  
**NEWMIX80 / 40** **380**

MICROULTRAGRANIT € IVA esclusa

UG 70 NERO MATT  
**NEWMIX80 / 70**

UG 72 TARTUFO  
**NEWMIX80 / 72** **420**

UG 98 BIANCO  
**NEWMIX80 / 98**

ULTRAMETAL € IVA esclusa

UM 41 ALLUMINIO  
**NEWMIX80 / 41**

UM 42 TITANIO  
**NEWMIX80 / 42** **440**

UM 44 NERO  
**NEWMIX80 / 44**

NANOSTONE € IVA esclusa

NS N1 BIANCO LATTE  
**NEWMIX80 / N1**

NS N3 ARGAN  
**NEWMIX80 / N3** **460**

NS N4 URBAN GREY  
**NEWMIX80 / N4**

NS N6 DEEP BLACK  
**NEWMIX80 / N6**

## NEWMIX90

Miscelatore monocomando  
con bocchetta estraibile a doppio getto.



- Cartuccia a dischi ceramici Ø35 mm (bassa)
- Rotazione canna: 180°
- Foro sul lavello: Ø35 mm
- Flessibili di allacciamento in acciaio inox, L=35 cm
- Flessibile doccetta in nylon, L=150 cm
- Diametro base: 54 mm

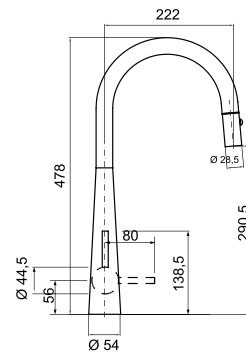

€ IVA esclusa

40 CROMO  
**NEWMIX90 / 40** **455**

MICROULTRAGRANIT € IVA esclusa

UG 70 NERO MATT  
**NEWMIX90 / 70**

UG 72 TARTUFO  
**NEWMIX90 / 72** **495**

UG 98 BIANCO  
**NEWMIX90 / 98**

ULTRAMETAL € IVA esclusa

UM 41 ALLUMINIO  
**NEWMIX90 / 41**

UM 42 TITANIO  
**NEWMIX90 / 42** **515**

UM 44 NERO  
**NEWMIX90 / 44**

NANOSTONE € IVA esclusa

NS N1 BIANCO LATTE  
**NEWMIX90 / N1**

NS N3 ARGAN  
**NEWMIX90 / N3** **535**

NS N4 URBAN GREY  
**NEWMIX90 / N4**

NS N6 DEEP BLACK  
**NEWMIX90 / N6**



PLADOS  
TELMA

PLADOS  
TELMA

## NEWMIX30

Miscelatore monocomando con canna tubolare a due pieghe.



- Cartuccia a dischi ceramici Ø35 mm (alta)
- Rotazione canna: 360°
- Foro sul lavello: Ø35 mm
- Flessibili di allacciamento in acciaio inox, L=35 cm
- Diametro base: 48 mm

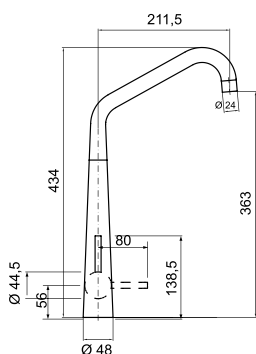

€ IVA esclusa

40 CROMO  
NEWMIX30 / 40 **380**

MICROULTRAGRANIT € IVA esclusa

UG 70 NERO MATT  
NEWMIX30 / 70

UG 72 TARTUFO  
NEWMIX30 / 72 **420**

UG 98 BIANCO  
NEWMIX30 / 98

ULTRAMETAL € IVA esclusa

UM 41 ALLUMINIO  
NEWMIX30 / 41

UM 42 TITANIO  
NEWMIX30 / 42 **440**

UM 44 NERO  
NEWMIX30 / 44

NANOSTONE € IVA esclusa

NS N1 BIANCO LATTE  
NEWMIX30 / N1

NS N3 ARGAN  
NEWMIX30 / N3 **460**

NS N4 URBAN GREY  
NEWMIX30 / N4

NS N6 DEEP BLACK  
NEWMIX30 / N6

## MIG10

Miscelatore monocomando con canna piatta.



- Cartuccia a dischi ceramici Ø28 mm
- Rotazione canna: 130°
- Foro sul lavello: Ø35 mm
- Flessibili di allacciamento in acciaio inox, L=35 cm
- Diametro base: 48 mm

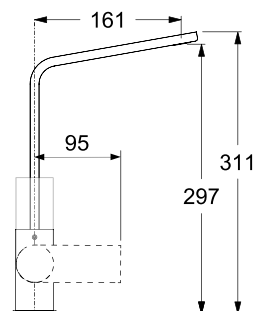

€ IVA esclusa

40 CROMO  
MIG10 / 40 **430**

MICROULTRAGRANIT € IVA esclusa

UG 70 NERO MATT  
MIG10 / 70 **470**

NANOSTONE € IVA esclusa

NS N6 DEEP BLACK  
MIG10 / N6 **510**





## SPIRIT

Miscelatore monocomando con canna piatta.



- Cartuccia a dischi ceramici Ø25 mm
- Rotazione canna: 180°
- Foro sul lavello: Ø35 mm
- Flessibili di allacciamento in acciaio inox, L=35 cm
- Diametro base: 48 mm

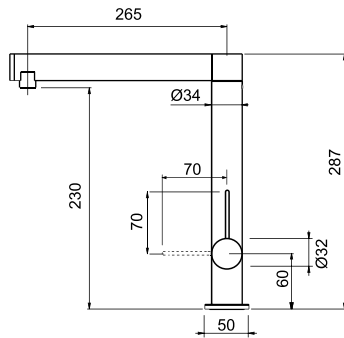

€ IVA esclusa

40 CROMO  
SPIRIT / 40 **490**

MICROULTRAGRANIT € IVA esclusa

UG 70 NERO MATT  
SPIRIT / 70 **530**

NANOSTONE € IVA esclusa

NS N6 DEEP BLACK  
SPIRIT / N6 **570**

## NILO

Miscelatore monocomando con leva frontale.



- Cartuccia a dischi ceramici Ø25 mm (bassa)
- Rotazione canna: 180°
- Foro sul lavello: Ø35 mm
- Flessibili di allacciamento in acciaio inox, L=35 cm
- Diametro base: 50 mm

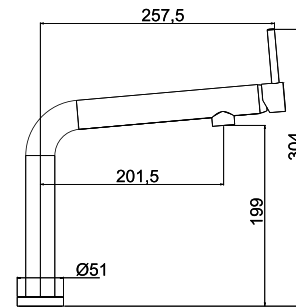

€ IVA esclusa

40 CROMO  
NILO / 40 **360**

MICROULTRAGRANIT € IVA esclusa

UG 70 NERO MATT  
NILO / 70 **400**

NANOSTONE € IVA esclusa

NS N6 DEEP BLACK  
NILO / N6 **420**



PLADOS  
TELMA

# NEMO

Miscelatore monocomando con canna a L e doccetta estraibile.



**NEW**



PVD ORO



PVD RAME



PVD BLACK



39 ACCIAIO SATINATO

- Cartuccia a dischi ceramici Ø35 mm (bassa)
- Rotazione canna: 180°
- Foro sul lavello: Ø35 mm
- Flessibili di allacciamento in acciaio inox, L=35 cm
- Diametro base: 50 mm

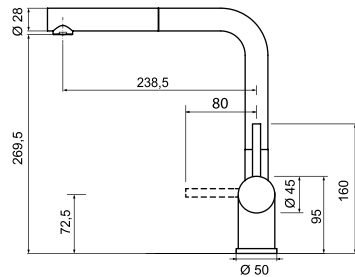

	€ IVA esclusa
 40 CROMO <b>NEMO / 40</b>	<b>350</b>
 39 ACCIAIO SATINATO <b>NEMO / 39</b>	<b>450</b>
 PVD ORO <b>NEMO / OR</b>	<b>450</b>
 PVD RAME <b>NEMO / RA</b>	<b>450</b>
 PVD BLACK <b>NEMO / BL</b>	<b>450</b>
<b>MICROULTRAGRANIT</b>	
 UG 70 NERO MATT <b>NEMO / 70</b>	<b>390</b>
<b>NANOSTONE</b>	
 NS N6 DEEP BLACK <b>NEMO / N6</b>	<b>430</b>



PLADOS

# COLONNA

Miscelatore monocomando con canna a L.



- Cartuccia a dischi ceramici Ø35 mm (bassa)
- Rotazione canna: 360°
- Foro sul lavello: Ø35 mm
- Flessibili di allacciamento in acciaio inox, L=35 cm
- Diametro base: 50 mm

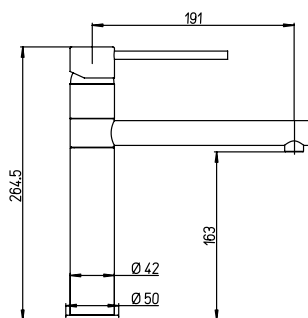

€ IVA esclusa



40 CROMO  
COLONNA / 40

265

## MICROULTRAGRANIT

€ IVA esclusa



UG 70 NERO MATT  
COLONNA / 70



UG 72 TARTUFO  
COLONNA / 72

305



UG 98 BIANCO  
COLONNA / 98

## ULTRAMETAL

€ IVA esclusa



UM 41 ALLUMINIO  
COLONNA / 41



UM 42 TITANIO  
COLONNA / 42

325



UM 44 NERO  
COLONNA / 44



## HYDRA

Miscelatore monocomando con doccia estraibile a doppio getto.



- Cartuccia a dischi ceramici Ø35 mm (alta)
- Rotazione canna: 180°
- Foro sul lavello: Ø35 mm
- Flessibili di allacciamento in acciaio inox, L=35 cm
- Flessibile doccia in nylon, L=150 cm
- Diametro base: 50 mm

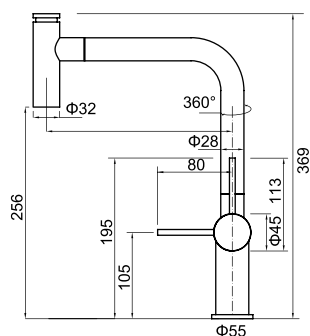

€ IVA esclusa

40 CROMO  
HYDRA / 40 **315**

MICROULTRAGRANIT € IVA esclusa

UG 70 NERO MATT  
HYDRA / 70 **355**

NANOSTONE € IVA esclusa

NS N6 DEEP BLACK  
HYDRA / N6 **395**

## DEMIXEXTL

Miscelatore monocomando con canna a 90° e doccia estraibile.



- Cartuccia a dischi ceramici Ø35 mm (alta)
- Rotazione canna: 180°
- Foro sul lavello: Ø35 mm
- Flessibili di allacciamento in acciaio inox, L=35 cm
- Flessibile doccia in nylon, L=150 cm
- Diametro base: 50 mm

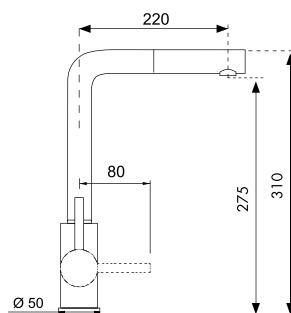

€ IVA esclusa

40 CROMO  
DEMIXEXTL / 40 **275**

MICROULTRAGRANIT € IVA esclusa

UG 56 JASMINE  
DEMIXEXTL / 56

UG 70 NERO MATT  
DEMIXEXTL / 70

UG 72 TARTUFO  
DEMIXEXTL / 72

UG 90 BIANCO OPALE  
DEMIXEXTL / 90 **315**

UG 94 AVENA  
DEMIXEXTL / 94

UG 95 NERO EBONY  
DEMIXEXTL / 95

UG 98 BIANCO  
DEMIXEXTL / 98

ULTRAMETAL

€ IVA esclusa

UM 41 ALLUMINIO  
DEMIXEXTL / 41

UM 42 TITANIO  
DEMIXEXTL / 42 **335**

UM 14 CONCRETE  
DEMIXEXTL / 14

UM 44 NERO  
DEMIXEXTL / 44

NANOSTONE € IVA esclusa

NS N1 BIANCO LATTE  
DEMIXEXTL / N1

NS N3 ARGAN  
DEMIXEXTL / N3 **355**

NS N4 URBAN GREY  
DEMIXEXTL / N4

NS N6 DEEP BLACK  
DEMIXEXTL / N6





## PARMIXEXT

Miscelatore monocomando con bocchetta estraibile e leva joystick.



- Cartuccia a dischi ceramici Ø25 mm
- Rotazione canna: 170°
- Foro sul lavello: Ø35 mm
- Flessibili di allacciamento in acciaio inox, L=35 cm
- Flessibile doccetta in nylon, L=150 cm
- Diametro base: 55 mm

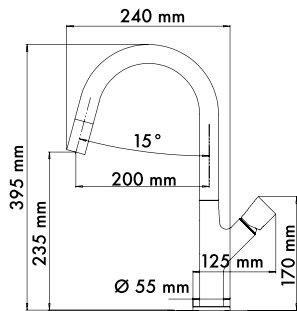

€ IVA esclusa



### MICROULTRAGRANIT

€ IVA esclusa



### ULTRAMETAL

€ IVA esclusa



### NANOSTONE

€ IVA esclusa



## PUNTOBPEX

Miscelatore monocomando con canna tubolare e bocchetta estraibile.



- Cartuccia a dischi ceramici Ø35 mm (alta)
- Rotazione canna: 180°
- Foro sul lavello: Ø35 mm
- Flessibili di allacciamento in acciaio inox, L=35 cm
- Flessibile doccetta in nylon, L=150 cm
- Diametro base: 50 mm

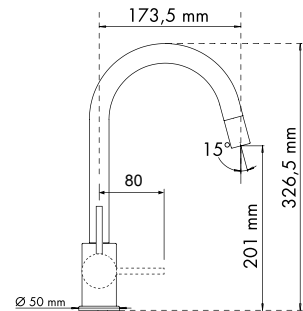

€ IVA esclusa



### MICROULTRAGRANIT

€ IVA esclusa



### ULTRAMETAL

€ IVA esclusa





PLADOS  
TELMA

## VENMIXEXT

Miscelatore monocomando con doccetta estraibile.



- Cartuccia a dischi ceramici Ø35 mm (bassa)
- Rotazione canna: 180°
- Foro sul lavello: Ø35 mm
- Flessibili di allacciamento in acciaio inox, L=35 cm
- Flessibile doccetta in nylon, L=150 cm
- Diametro base: 50 mm

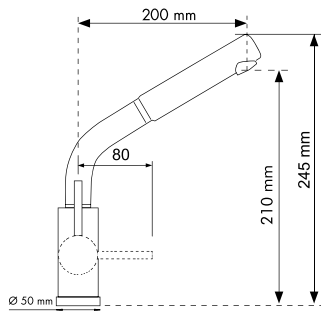

€ IVA esclusa

40 CROMO  
VENMIXEXT / 40 **275**

MICROULTRAGRANIT € IVA esclusa

UG 70 NERO MATT  
VENMIXEXT / 70

UG 72 TARTUFO  
VENMIXEXT / 72 **315**

UG 98 BIANCO  
VENMIXEXT / 98

ULTRAMETAL € IVA esclusa

UM 41 ALLUMINIO  
VENMIXEXT / 41

UM 42 TITANIO  
VENMIXEXT / 42 **335**

UM 44 NERO  
VENMIXEXT / 44

## TIZMIXEXT

Miscelatore monocomando con doccetta estraibile a doppio getto.



- Cartuccia a dischi ceramici Ø35 mm (alta)
- Rotazione canna: 120°
- Foro sul lavello: Ø35 mm
- Flessibili di allacciamento in acciaio inox, L=50 cm
- Flessibile doccetta in nylon, L=150 cm
- Diametro base: 50 mm

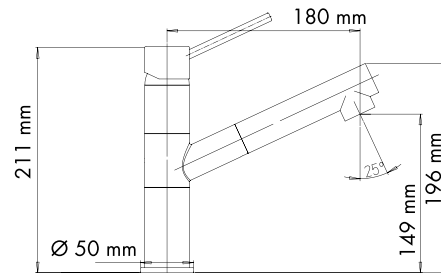

€ IVA esclusa

40 CROMO  
TIZMIXEXT / 40 **300**

MICROULTRAGRANIT € IVA esclusa

UG 70 NERO MATT  
TIZMIXEXT / 70

UG 94 AVENA  
TIZMIXEXT / 94 **340**

UG 98 BIANCO  
TIZMIXEXT / 98

ULTRAMETAL € IVA esclusa

UM 41 ALLUMINIO  
TIZMIXEXT / 41

UM 42 TITANIO  
TIZMIXEXT / 42 **360**

UM 44 NERO  
TIZMIXEXT / 44

## SLIMFIX

Miscelatore monocomando con corpo "slim" e canna a ponte.



- Cartuccia a dischi ceramici Ø25 mm
- Rotazione canna: 360°
- Foro sul lavello: Ø35 mm
- Flessibili di allacciamento in acciaio inox, L=35 cm
- Diametro base: 45 mm

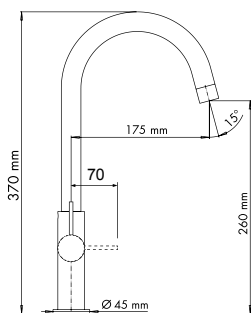

€ IVA esclusa

40 CROMO  
SLIMFIX / 40 **230**

### MICROULTRAGRANIT

€ IVA esclusa

UG 70 NERO MATT  
SLIMFIX / 70

UG 72 TARTUFO  
SLIMFIX / 72 **270**

UG 98 BIANCO  
SLIMFIX / 98

### ULTRAMETAL

€ IVA esclusa

UM 41 ALLUMINIO  
SLIMFIX / 41

UM 42 TITANIO  
SLIMFIX / 42 **290**

UM 44 NERO  
SLIMFIX / 44

## VENMIXL

Miscelatore monocomando canna a 90°.



- Cartuccia a dischi ceramici Ø25 mm (bassa)
- Rotazione canna: 360°
- Foro sul lavello: Ø35 mm
- Flessibili di allacciamento in acciaio inox, L=35 cm
- Diametro base: 45 mm

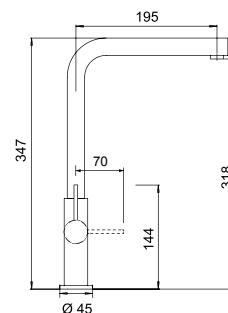

€ IVA esclusa

40 CROMO  
VENMIXL / 40 **235**

### MICROULTRAGRANIT

€ IVA esclusa

UG 56 JASMINE  
VENMIXL / 56

UG 70 NERO MATT  
VENMIXL / 70

UG 72 TARTUFO  
VENMIXL / 72

UG 90 BIANCO OPALE  
VENMIXL / 90 **275**

UG 94 AVENA  
VENMIXL / 94

UG 95 NERO EBONY  
VENMIXL / 95

UG 98 BIANCO  
VENMIXL / 98

### ULTRAMETAL

€ IVA esclusa

UM 41 ALLUMINIO  
VENMIXL / 41

UM 42 TITANIO  
VENMIXL / 42 **295**

UM 14 CONCRETE  
VENMIXL / 14

UM 44 NERO  
VENMIXL / 44

### NANOSTONE

€ IVA esclusa

NS N1 BIANCO LATTE  
VENMIXL / N1

NS N3 ARGAN  
VENMIXL / N3 **315**

NS N4 URBAN GREY  
VENMIXL / N4

NS N6 DEEP BLACK  
VENMIXL / N6

## TIZEK

Miscelatore monocomando con canna girevole.



- Cartuccia a dischi ceramici Ø35 mm (bassa)
- Rotazione canna: 360°
- Foro sul lavello: Ø35 mm
- Flessibili di allacciamento in acciaio inox, L=35 cm
- Diametro base: 50 mm

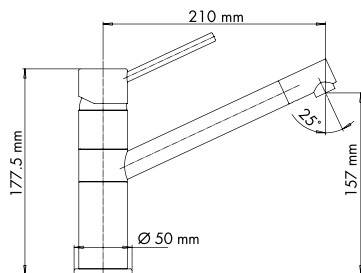

€ IVA esclusa

40 CROMO  
TIZEK / 40 **240**

### MICROULTRAGRANIT

€ IVA esclusa

UG 70 NERO MATT  
TIZEK / 70

UG 94 AVENA  
TIZEK / 94 **280**

UG 98 BIANCO  
TIZEK / 98

### ULTRAMETAL

€ IVA esclusa

UM 41 ALLUMINIO  
TIZEK / 41

UM 42 TITANIO  
TIZEK / 42 **300**

UM 44 NERO  
TIZEK / 44

## EASY

Miscelatore monocomando con canna girevole a L.



- Cartuccia a dischi ceramici Ø35 mm (bassa)
- Rotazione canna: 360°
- Foro sul lavello: Ø35 mm
- Flessibili di allacciamento in acciaio inox, L=35 cm
- Diametro base: 50 mm

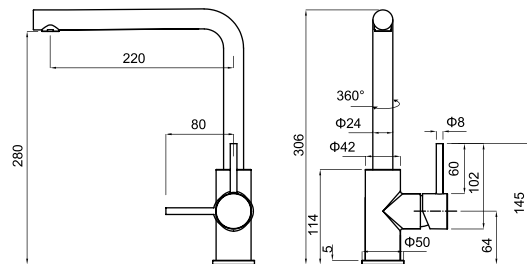

€ IVA esclusa

40 CROMO  
EASY / 40 **210**

### MICROULTRAGRANIT

€ IVA esclusa

UG 70 NERO MATT  
EASY / 70

UG 72 TARTUFO  
EASY / 72 **250**

UG 94 AVENA  
EASY / 94

UG 98 BIANCO  
EASY / 98

### ULTRAMETAL

€ IVA esclusa

UM 41 ALLUMINIO  
EASY / 41

UM 42 TITANIO  
EASY / 42 **270**

UM 44 NERO  
EASY / 44

## PETRAMIX

Miscelatore monocomando con canna tubolare.



- Cartuccia a dischi ceramici Ø35 mm (alta)
- Rotazione canna: 360°
- Foro sul lavello: Ø35 mm
- Flessibili di allacciamento in acciaio inox, L=35 cm
- Diametro base: 50 mm

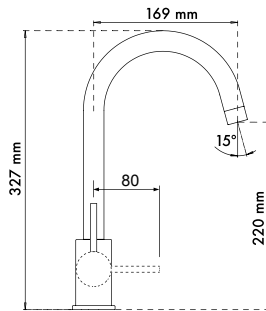

€ IVA esclusa

40 CROMO  
**PETRAMIX / 40** **180**

**ULTRAQUARTZ** € IVA esclusa

UG 66 TERRA DI FRANCIA  
**PETRAMIX / 66** **220**

**MICROULTRAGRANIT** € IVA esclusa

UG 56 JASMINE  
**PETRAMIX / 56**

UG 70 NERO MATT  
**PETRAMIX / 70**

UG 90 BIANCO OPALE  
**PETRAMIX / 90** **220**

UG 94 AVENA  
**PETRAMIX / 94**

UG 95 NERO EBONY  
**PETRAMIX / 95**

UG 98 BIANCO  
**PETRAMIX / 98**

**ULTRAMETAL** € IVA esclusa

UM 41 ALLUMINIO  
**PETRAMIX / 41**

UM 42 TITANIO  
**PETRAMIX / 42** **240**

UM 44 NERO  
**PETRAMIX / 44**

## VENMIX20

Miscelatore monocomando con canna tubolare.



- Cartuccia a dischi ceramici Ø35 mm (bassa)
- Rotazione canna: 360°
- Foro sul lavello: Ø35 mm
- Flessibili di allacciamento in acciaio inox, L=35 cm
- Diametro base: 50 mm

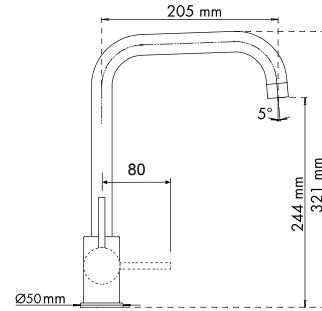

€ IVA esclusa

40 CROMO  
**VENMIX20 / 40** **180**

**MICROULTRAGRANIT** € IVA esclusa

UG 56 JASMINE  
**VENMIX20 / 56**

UG 70 NERO MATT  
**VENMIX20 / 70**

UG 90 BIANCO OPALE  
**VENMIX20 / 90** **220**

UG 94 AVENA  
**VENMIX20 / 94**

UG 95 NERO EBONY  
**VENMIX20 / 95**

UG 98 BIANCO  
**VENMIX20 / 98**

**ULTRAMETAL** € IVA esclusa

UM 41 ALLUMINIO  
**VENMIX20 / 41**

UM 42 TITANIO  
**VENMIX20 / 42** **240**

UM 44 NERO  
**VENMIX20 / 44**

## EUROMIX

Miscelatore monocomando con canna fusa.



- Cartuccia a dischi ceramici Ø35 mm (alta)
- Rotazione canna: 360°
- Foro sul lavello: Ø35 mm
- Flessibili di allacciamento in acciaio inox, L=35 cm
- Diametro base: 50 mm

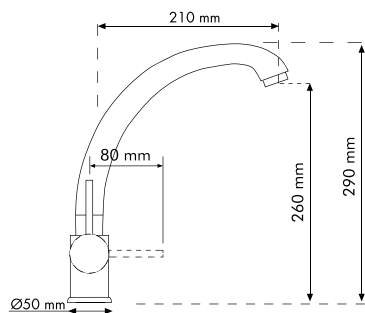

€ IVA esclusa

	40 CROMO EUROMIX / 40	170
---	--------------------------	-----

### MICROULTRAGRANIT

€ IVA esclusa

	UG 70 NERO MATT EUROMIX / 70	
	UG 94 AVENA EUROMIX / 94	210
	UG 98 BIANCO EUROMIX / 98	

## NEOMIX

Miscelatore monocomando con bocca orientabile e leva laterale.



- Cartuccia a dischi ceramici Ø40 mm (alta)
- Rotazione canna: 360°
- Foro sul lavello: Ø35 mm
- Flessibili di allacciamento in acciaio inox, L=35 cm
- Diametro base: 50 mm

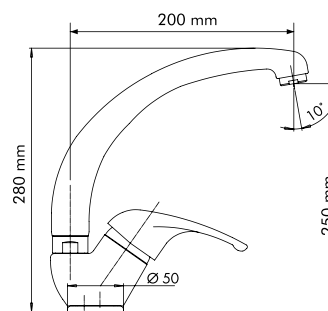



€ IVA esclusa

	40 CROMO NEOMIX / 40	150
--	-------------------------	-----

### MICROULTRAGRANIT

€ IVA esclusa

	UG 70 NERO MATT NEOMIX / 70	
	UG 94 AVENA NEOMIX / 94	190
	UG 98 BIANCO NEOMIX / 98	



## PLUSMIX

Miscelatore monocomando con canna a tubo.



- Cartuccia a dischi ceramici Ø40 mm (alta)
- Rotazione canna: 360°
- Foro sul lavello: Ø35 mm
- Flessibili di allacciamento in acciaio inox, L=35 cm
- Diametro base: 53 mm

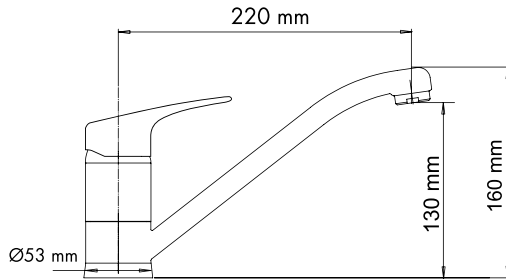

€ IVA esclusa

40 CROMO  
PLUSMIX / 40 **130**

### MICROULTRAGRANIT

€ IVA esclusa

UG 56 JASMINE  
PLUSMIX / 56

UG 70 NERO MATT  
PLUSMIX / 70

UG 90 BIANCO OPALE  
PLUSMIX / 90 **170**

UG 94 AVENA  
PLUSMIX / 94

UG 95 NERO EBONY  
PLUSMIX / 95

UG 98 BIANCO  
PLUSMIX / 98

### ULTRAMETAL

€ IVA esclusa

UM 41 ALLUMINIO  
PLUSMIX / 41

UM 42 TITANIO  
PLUSMIX / 42 **190**

UM 44 NERO  
PLUSMIX / 44

## PLUSMIXEXT

Miscelatore monocomando con doccetta estraibile a doppio getto.



- Cartuccia a dischi ceramici Ø40 mm (alta)
- Rotazione canna: 120°
- Foro sul lavello: Ø35 mm
- Flessibili di allacciamento in acciaio inox, L=35 cm
- Flessibile doccetta in nylon, L=150 cm
- Diametro base: 53 mm

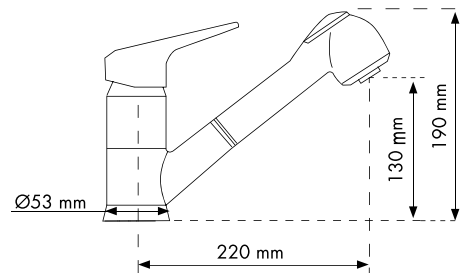

€ IVA esclusa

40 CROMO  
PLUSMIXEXT / 40 **210**

### MICROULTRAGRANIT

€ IVA esclusa

UG 56 JASMINE  
PLUSMIXEXT / 56

UG 70 NERO MATT  
PLUSMIXEXT / 70

UG 90 BIANCO OPALE  
PLUSMIXEXT / 90 **250**

UG 94 AVENA  
PLUSMIXEXT / 94

UG 95 NERO EBONY  
PLUSMIXEXT / 95

UG 98 BIANCO  
PLUSMIXEXT / 98

### ULTRAMETAL

€ IVA esclusa

UM 41 ALLUMINIO  
PLUSMIXEXT / 41

UM 42 TITANIO  
PLUSMIXEXT / 42 **270**

UM 44 NERO  
PLUSMIXEXT / 44

## WINMIX

Miscelatore monocomando con canna abbattibile per sottofinestra.



- Cartuccia a dischi ceramici Ø25 mm
- Rotazione canna: 360°
- Foro sul lavello: Ø35 mm
- Flessibili di allacciamento in acciaio inox, L=35 cm
- Diametro base: 55 mm

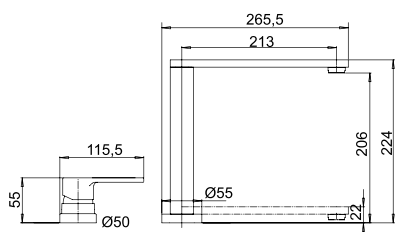

**SOTTOFINESTRA**  
altezza minima 55 mm

	€ IVA esclusa
 40 CROMO <b>WINMIX / 40</b>	<b>590</b>

## NOVOMIX

Miscelatore monocomando con canna pieghevole per sottofinestra.





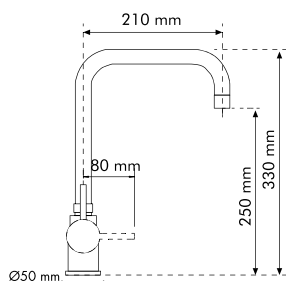



- Cartuccia a dischi ceramici Ø40 mm (alta)
- Rotazione canna: 180°
- Foro sul lavello: Ø35 mm
- Flessibili di allacciamento in acciaio inox, L=35 cm
- Diametro base: 50 mm





**SOTTOFINESTRA**  
altezza minima 80 mm

	€ IVA esclusa
 40 CROMO <b>NOVOMIX / 40</b>	<b>340</b>

### MICROULTRAGRANIT

	€ IVA esclusa
 UG 56 JASMINE <b>NOVOMIX / 56</b>	
 UG 70 NERO MATT <b>NOVOMIX / 70</b>	
 UG 72 TARTUFO <b>NOVOMIX / 72</b>	
 UG 90 BIANCO OPALE <b>NOVOMIX / 90</b>	<b>380</b>
 UG 94 AVENA <b>NOVOMIX / 94</b>	
 UG 95 NERO EBONY <b>NOVOMIX / 95</b>	
 UG 98 BIANCO <b>NOVOMIX / 98</b>	

### ULTRAMETAL

	€ IVA esclusa
 UM 41 ALLUMINIO <b>NOVOMIX / 41</b>	
 UM 42 TITANIO <b>NOVOMIX / 42</b>	<b>400</b>
 UM 44 NERO <b>NOVOMIX / 44</b>	

## MIXOLDST



Miscelatore monocomando "Old Fashion" con canna pieghevole per sottofinestra.

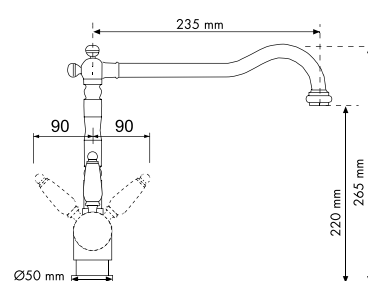

- Cartuccia a dischi ceramici Ø40 mm (alta)
- Rotazione canna: 180°
- Foro sul lavello: Ø35 mm
- Flessibili di allacciamento in acciaio inox, L=35 cm
- Diametro base: 50 mm



**SOTTOFINESTRA**  
altezza minima 80 mm

	€ IVA esclusa
 40 CROMO <b>MIXOLDST / 40</b>	<b>420</b>
 17 RAME ANTICATO <b>MIXOLDST / 17</b>	<b>460</b>
 18 BRONZO ANTICATO <b>MIXOLDST / 18</b>	<b>460</b>



PLADOS  
TELMA





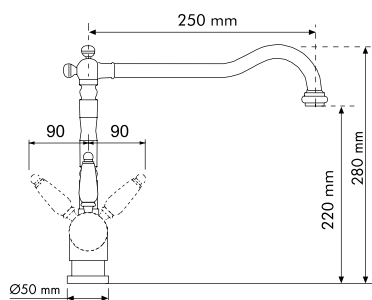

## MIXOLD

Miscelatore monocomando "Old Fashion" con canna girevole e leva laterale.



- Cartuccia a dischi ceramici Ø40 mm (alta)
- Rotazione canna: 360°
- Foro sul lavello: Ø35 mm
- Flessibili di allacciamento in acciaio inox, L=35 cm
- Diametro base: 50 mm



		€ IVA esclusa
	40 CROMO <b>MIXOLD / 40</b>	<b>300</b>
	17 RAME ANTICATO <b>MIXOLD / 17</b>	<b>340</b>
	18 BRONZO ANTICATO <b>MIXOLD / 18</b>	<b>340</b>
<b>MICROULTRAGRANIT</b>		
	UG 56 JASMINE <b>MIXOLD / 56</b>	<b>320</b>
	UG 70 NERO MATT <b>MIXOLD / 70</b>	
	UG 94 AVENA <b>MIXOLD / 94</b>	
	UG 98 BIANCO <b>MIXOLD / 98</b>	

## IDEAOLD

Gruppo monoforo con canna "Old Fashion" e maniglie a croce.



- Vitoni a bagno olio
- Rotazione canna: 360°
- Foro sul lavello: Ø35 mm
- Flessibili di allacciamento in acciaio inox, L=35 cm
- Diametro base: 45 mm

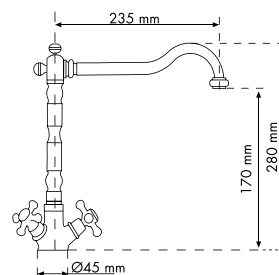

		€ IVA esclusa
	40 CROMO <b>IDEAOLD / 40</b>	<b>250</b>
	17 RAME ANTICATO <b>IDEAOLD / 17</b>	<b>290</b>
	18 BRONZO ANTICATO <b>IDEAOLD / 18</b>	<b>290</b>



FORNI





Dal design moderno a quello classico,  
i forni multifunzione Plados sono elettrodomestici  
di **CLASSE A** rigorosamente **Made in Italy** e garantiscono  
la massima qualità e attenzione ai dettagli.





# FORNI

## CARATTERISTICHE DI PRODOTTO

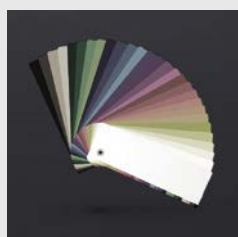

### COLORI TRENDY

I forni Plados sono disponibili nelle finiture più in voga nelle cucine contemporanee.

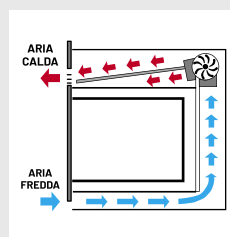

### RAFFREDDAMENTO TANGENZIALE

Una ventola esterna al forno evita il surriscaldamento dei mobili adiacenti, la formazione di condensa e di umidità.

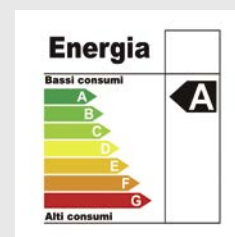

### CLASSE A

Scegliere un elettrodomestico ad elevata efficienza energetica **ripaga in termini di costi energetici**.

### FINITURE



### PLUS



ITALIAN  
TECHNOLOGY

### CORREDO

- Griglia
- Leccarda

### INSTALLAZIONE

- Incasso

# FIDIG / FORNO



UG Nero Matt 70



UG Bianco 98



UG Nero Matt 70



UG Tartufo 72



UM Alluminio 41



UM Titanio 42

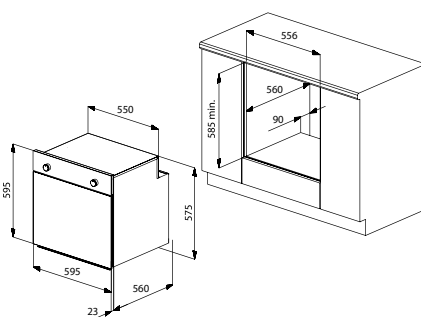

## COLORI DISPONIBILI

€ IVA esclusa



UG 98  
BIANCO  
FIDIG / 98



UG 70  
NERO MATT  
FIDIG / 70



UG 72  
TARTUFO  
FIDIG / 72

1.040

## COLORI DISPONIBILI

€ IVA esclusa



UM 41  
ALLUMINIO  
FIDIG / 41



UM 42  
TITANIO  
FIDIG / 42

1.040

## DOTAZIONE

- 1 griglia
- 1 vassoio standard

## CARATTERISTICHE

- Forno termo ventilato
- Classe di efficienza energetica A
- 9 funzioni
- Cavità extralarge 64 lt netti
- Ventilazione tangenziale di raffreddamento
- 5 livelli di cottura
- Porta fredda in triplo vetro temperato
- Vetro interno removibile
- Programmatore elettronico touch nuova generazione
- Interno con smalto titanium easy-to-clean, più facile da pulire
- Luce interna
- Maniglia nera e manopole milleluci nere



grill



grill ventilato



cottura ventilata



cottura tradizionale ventilata



cottura inferiore ventilata



resistenza superiore + inferiore



resistenza superiore



resistenza inferiore



scongelamento



luce interna



64 L capacità



raffreddamento tangenziale

# FIMOD / FORNO



UG Tartufo 72



UG Bianco 98



UG Nero Matt 70



UG Tartufo 72



UM Alluminio 41



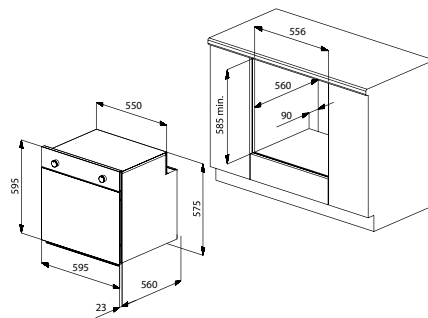

UM Titanio 42



## COLORI DISPONIBILI

€ IVA esclusa

-  UG 98  
BIANCO  
**FIMOD / 98**
-  UG 70  
NERO MATT  
**FIMOD / 70**
-  UG 72  
TARTUFO  
**FIMOD / 72**

**895**

## COLORI DISPONIBILI

€ IVA esclusa

-  UM 41  
ALLUMINIO  
**FIMOD / 41**
-  UM 42  
TITANIO  
**FIMOD / 42**

**895**

### DOTAZIONE

- 1 griglia
- 1 vassoio standard

### CARATTERISTICHE

- Forno ventilato
- Classe di efficienza energetica A
- 7 funzioni
- Cavità extralarge 64 lt netti
- Ventilazione tangenziale di raffreddamento
- 5 livelli di cottura
- Porta fredda in triplo vetro temperato
- Vetro interno removibile
- Programmatore meccanico con fine cottura
- Interno con smalto titanium easy-to-clean, più facile da pulire
- Luce interna
- Maniglia nera e manopole milleluci nere



grill



cottura tradizionale ventilata



resistenza superiore + inferiore



resistenza superiore



resistenza inferiore



scongelamento



luce interna



**64 L** capacità



raffreddamento tangenziale

# FITER / FORNO

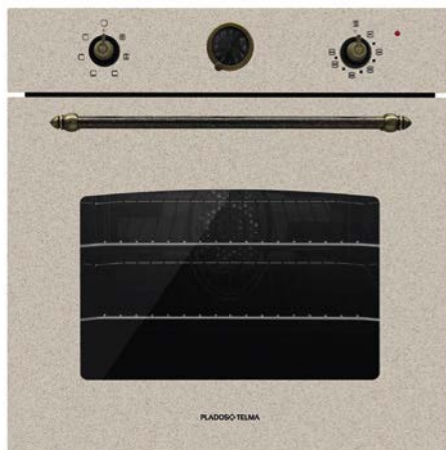

UG Avena 94

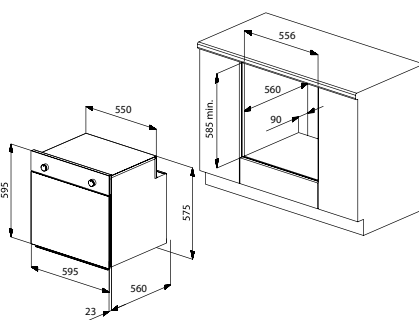

## COLORI DISPONIBILI

€ IVA esclusa



UG 94  
AVENA  
FITER / 94

**970**

## DOTAZIONE

- 1 griglia
- 1 vassoio standard

## CARATTERISTICHE

- Forno ventilato
- Classe di efficienza energetica A
- 6 funzioni
- Cavità extralarge 64 lt netti
- Ventilazione tangenziale di raffreddamento
- 5 livelli di cottura
- Porta fredda in triplo vetro temperato
- Vetro interno removibile
- Programmatore meccanico con fine cottura
- Interno con smalto titanium easy-to-clean, più facile da pulire
- Luce interna
- Maniglia e manopole finitura bronzo anticato



grill



cottura tradizionale ventilata



resistenza superiore + inferiore



resistenza superiore



resistenza inferiore



scongelamento



luce interna



**64 L** capacità



raffreddamento tangenziale

# LEGENDA SIMBOLI E RELATIVE FUNZIONI

## SIMBOLOGIA FORNI:



### COTTURA VENTILATA

La combinazione tra la ventola e la resistenza circolare permette la cottura di cibi diversi su più piani senza mescolanza di odori o sapori. Questa funzione è particolarmente indicata per cibi che devono essere ben cotti all'esterno e morbidi o rosei all'interno.



### GRILL VENTILATO

Il funzionamento della ventola in combinazione con il grill esalta e velocizza le operazioni di gratinatura e grigliatura, con una maggiore distribuzione del calore, impedendo la bruciatura superficiale degli alimenti.



### GRILL

Ideale per gratinare e grigliare le pietanze che necessitano di un'elevata temperatura superficiale come bistecche di vitello o manzo, filetto, hamburger e tutti i contorni di verdure alla griglia.



### COTTURA TRADIZIONALE VENTILATA

Il funzionamento della ventola abbinato alla cottura tradizionale, diffonde il calore in modo uniforme all'interno del forno e risulta particolarmente indicata per cibi che richiedono lo stesso grado di cottura interno ed esterno quali arrostiti arrotondati, cosciotti, pesci interi, anche cotti simultaneamente su più livelli.



### COTTURA INFERIORE VENTILATA

Il funzionamento della ventola abbinato alla cottura inferiore è ideale per dolci, torte e biscotti.



### RESISTENZA SUPERIORE + INFERIORE (COTTURA TRADIZIONALE)

Il calore proveniente contemporaneamente dall'alto e dal basso, rende questa funzione ideale per pizze, torte, arrostiti di qualsiasi tipo e per carni grasse come anatra od oca.



### RESISTENZA SUPERIORE (DORATURA)

Il calore proveniente solo dall'alto consente di completare le cotture di quei piatti che richiedono una leggera doratura superficiale. Ideale per rifinire la cottura di arrostiti e verdure.



### RESISTENZA INFERIORE (COTTURA FINALE)

Il calore proveniente solo dal basso consente di rifinire le cotture che necessitano di una maggiore temperatura alla base. Indicata per completare la cottura di torte dolci o salate, pizze e crostate.



### SCONGELAMENTO

Scongela delicatamente grazie all'azione della ventola interna.



### LUCE FORNO

Permette di illuminare l'interno del forno per poter controllare la cottura dei cibi.



### CAPACITÀ

È il volume interno del forno, cioè lo spazio utilizzabile per la cottura.



### RAFFREDDAMENTO TANGENZIALE

Una ventola posta all'esterno del vano forno crea una corrente d'aria che evita il surriscaldamento dei mobili adiacenti, la formazione di condensa e di umidità.

## CLASSI ENERGETICHE

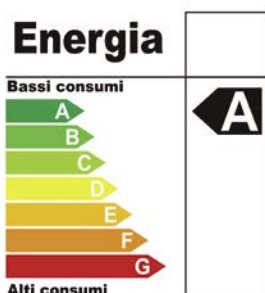

Le Direttive Europee stabiliscono la necessità di applicare un'etichetta energetica su tutti gli elettrodomestici. L'etichetta energetica classifica gli apparecchi in base al consumo di energia e di altre risorse, consentendo al consumatore di effettuare una **sceita consapevole** nel rispetto dell'ambiente e dell'economia. La lettera A indica consumi minori, le lettere dalla B in poi indicano consumi via via crescenti. Scegliere un elettrodomestico ad elevata efficienza energetica **ripaga in termini di costi sulla bolletta**. Gli elettrodomestici di CLASSE A sono progettati per funzionare con alti rendimenti, ottimizzando il consumo di energia e quindi riducendo l'inquinamento atmosferico.

**Ridurre le spese in bolletta e contribuire ad un ambiente più pulito significa pensare al futuro del nostro pianeta ed è un dovere di tutti.**



# PIANI COTTURA A INDUZIONE

La superficie liscia dei piani a induzione rende la pulizia facile e veloce! A differenza dei piani cottura a gas con griglie e bruciatori che devono essere rimossi e riposizionati di volta in volta, il piano ad induzione torna a brillare con un semplice colpo di spugna.

PLADOS TELMA  
INDUCTION





# PIANI COTTURA A INDUZIONE CARATTERISTICHE DI PRODOTTO



## PASSARE ALL'INDUZIONE È PIÙ SEMPLICE DI QUANTO PENSI.

Che si tratti della sostituzione di un vecchio piano cottura o di una prima installazione, il foro per l'incasso dei piani induzione Plados è compatibile con l'apertura standard dei piani cottura a gas. La profondità è sempre 48 cm.



ITALIAN  
TECHNOLOGY

### POWER MANAGEMENT SYSTEM:

Consente di regolare la potenza massima assorbita: il piano gestisce automaticamente la potenza in modo da non superare il limite impostato. La soglia può essere regolata scegliendo tra 4 diversi livelli (1 kW - 2,8 kW - 3,6 kW - 5,2 kW) a seconda del modello;

### BOOSTER:

Nei piani dotati di funzione Booster, l'utente può incrementare la potenza di una zona cottura per velocizzare ulteriormente i processi di cottura;

### OVERFLOW SAFETY:

In caso di fuoriuscita di un liquido da una pentola il piano si disattiva automaticamente;

### BLOCCO DI SICUREZZA DEI COMANDI:

Una funzione di sicurezza per bloccare il piano, evitando accensioni accidentali o il cambio dei parametri precedentemente impostati.

### POT DIAMETER DETECTION:

Il piano riconosce le dimensioni della pentola che viene appoggiata, attivando solo la porzione necessaria allo specifico diametro.

## EFFICIENZA E RISPARMIO ENERGETICO

Il 90% dell'energia assorbita viene trasformata in calore. Appena la pentola viene rimossa dalla zona cottura, il trasferimento di energia viene interrotto evitando sprechi.

CONSUMI IN WATT: - 42%

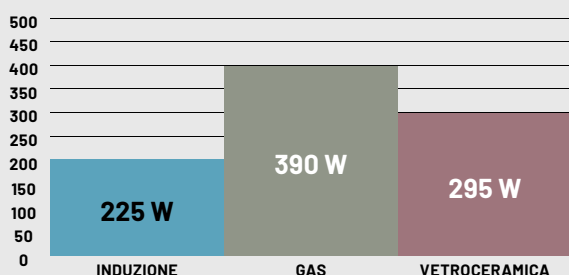

## VELOCITÀ + 68%

Nei piani provvisti della funzione **Booster** l'utente può incrementare la potenza per abbattere drasticamente i processi di cottura.

MINUTI PER PORTARE 2 LITRI D'ACQUA DA 15 A 90 °C

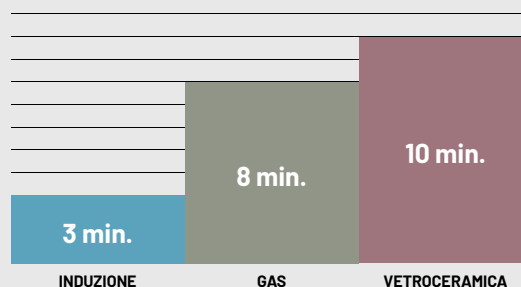

## PBIL320C / INDUZIONE

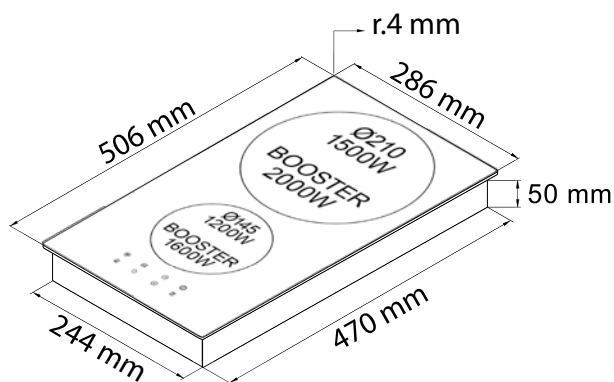
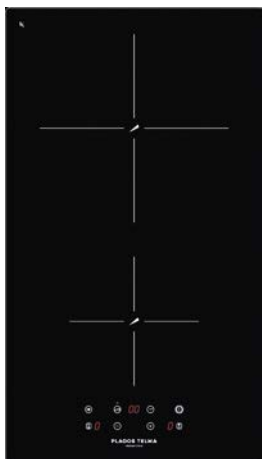

Foro per l'incasso:  
270 x 480 mm

€ IVA  
esclusa



CRISTALLO NERO  
PBIL320C / K2

585

## PBIM430 / INDUZIONE

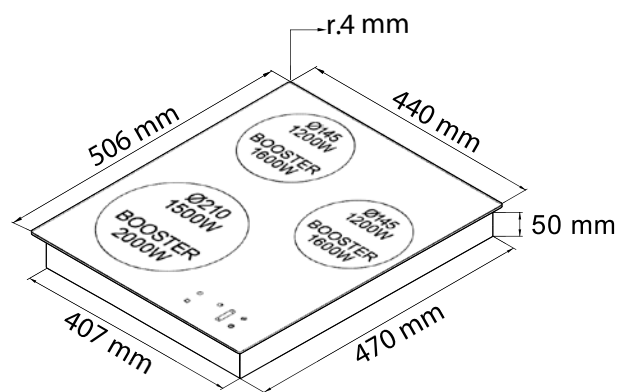
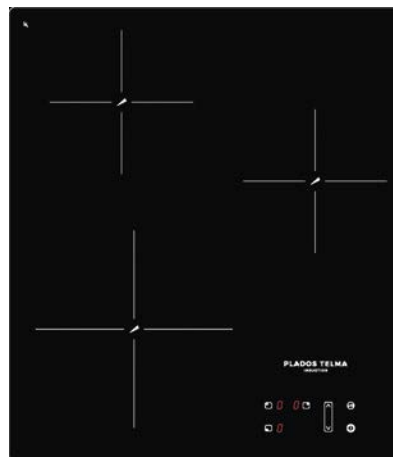

Foro per l'incasso:  
420 x 480 mm

€ IVA  
esclusa



CRISTALLO NERO  
PBIM430 / K2

820

### CARATTERISTICHE

<b>Assorbimento massimo:</b>	3,6 kW
<b>Dimensioni:</b>	29x51x5 cm
<b>Versione standard:</b>	Senza cornice
<b>Comandi:</b>	Controlli touch - 9 livelli di potenza
<b>Zone cottura</b>	2
<b>Indicatore di potenza:</b>	Si
<b>Indicatore di calore residuo per zona:</b>	Si
<b>Blocco sicurezza comandi:</b>	Si
<b>Timer</b>	Si
<b>PMS</b>	Si (Limitatore di consumo)
<b>Booster</b>	Si (Potenza supplementare)
<b>Pot Diameter Detection</b>	Si (Sensore diametro pentola)
<b>Overflow Safety</b>	Si (Sensore fuoriuscita liquidi)

### CARATTERISTICHE

<b>Assorbimento massimo:</b>	5,2 kW
<b>Dimensioni:</b>	44x51x5 cm
<b>Versione standard:</b>	Senza cornice
<b>Comandi:</b>	Controlli touch - 9 livelli di potenza
<b>Zone cottura</b>	3
<b>Indicatore di potenza:</b>	Si
<b>Indicatore di calore residuo per zona:</b>	Si
<b>Blocco sicurezza comandi:</b>	Si
<b>Timer</b>	Si
<b>PMS</b>	Si (Limitatore di consumo)
<b>Booster</b>	Si (Potenza supplementare)
<b>Pot Diameter Detection</b>	Si (Sensore diametro pentola)
<b>Overflow Safety</b>	Si (Sensore fuoriuscita liquidi)

# PBIM640C / INDUZIONE

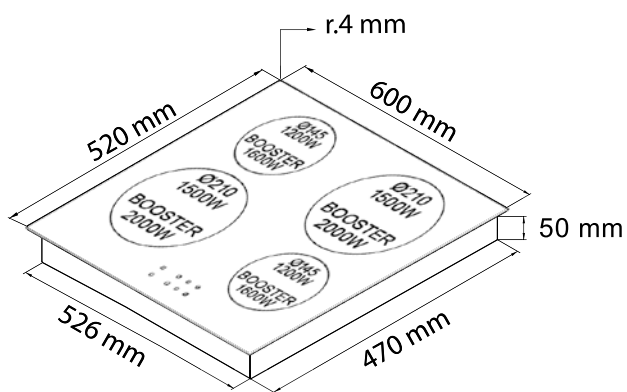
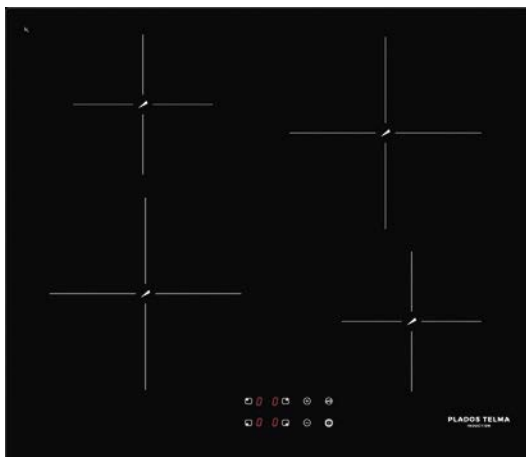

Foro per l'incasso:  
560 x 480 mm

€ IVA  
esclusa



CRISTALLO NERO  
PBIM640C / K2

850

## CARATTERISTICHE

<b>Assorbimento massimo:</b>	7,2 kW
<b>Dimensioni:</b>	60x52x5 cm
<b>Versione standard:</b>	Senza cornice
<b>Comandi:</b>	Controlli touch - 9 livelli di potenza
<b>Zone cottura</b>	4
<b>Indicatore di potenza:</b>	Si
<b>Indicatore di calore residuo per zona:</b>	Si
<b>Blocco sicurezza comandi:</b>	Si
<b>Timer</b>	Si
<b>Booster</b>	Si (Potenza supplementare)
<b>Pot Diameter Detection</b>	Si (Sensore diametro pentola)
<b>Overflow Safety</b>	Si (Sensore fuoriuscita liquidi)



# PIANI COTTURA A GAS





# PIANI COTTURA A GAS CARATTERISTICHE DI PRODOTTO

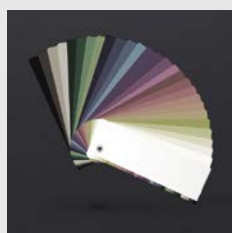

## COLORI TRENDY

I piani cottura Plados sono disponibili nelle finiture più in voga nelle cucine contemporanee.



## AMPIA GAMMA

10 modelli per coprire ogni necessità dal classico al moderno.



## TRIPLA CORONA

3 potenti cerchi di fuoco per una cottura rapida e omogenea.

## FINITURE



## PLUS



ITALIAN  
TECHNOLOGY

## CORREDO

- Griglie in ghisa
- Griglie smaltate (serie STAR)

## ACCESSORI

- Griglie in ghisa (serie STAR)
- manopole anticate
- manopole moderne

# GLASS75 / PIANO COTTURA



Cristallo Nero

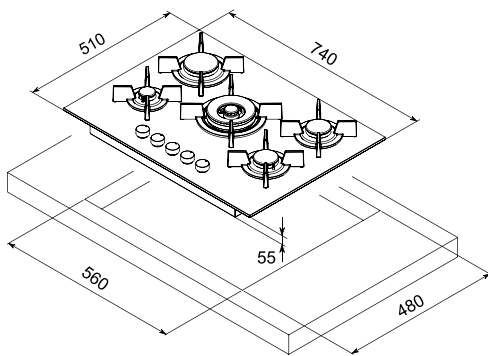

€ IVA esclusa



CRISTALLO NERO  
GLASS75 / K2 **795**

# GLASS60 / PIANO COTTURA



Cristallo Nero

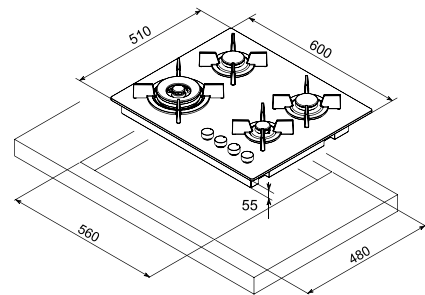

€ IVA esclusa



CRISTALLO NERO  
GLASS60 / K2 **645**

## DOTAZIONE

- Griglie in ghisa

## CARATTERISTICHE

- Piano cottura in cristallo nero da 75 cm
- 5 fuochi gas di cui 1 tripla corona
- Comandi frontali
- Accensione elettronica sottomanopola
- Valvola di sicurezza
- Coprispartifiamma e griglie in ghisa
- Manopole color nero ghisa.
- Entrata GAS posteriore sinistra
- Foro per l'incasso: 560 x 480 mm

## DOTAZIONE

- Griglie in ghisa

## CARATTERISTICHE

- Piano cottura in cristallo nero da 60 cm
- 4 fuochi gas di cui 1 tripla corona
- Comandi frontali
- Accensione elettronica sottomanopola
- Valvola di sicurezza
- Coprispartifiamma e griglie in ghisa
- Manopole color nero ghisa.
- Entrata GAS posteriore sinistra
- Foro per l'incasso: 560 x 480 mm

## ACCESSORI DISPONIBILI



Kit 5 manopole finitura  
cromo satinato  
MAMOD75 **35**



Kit 4 manopole finitura  
cromo satinato  
MAMOD60 **28**



# SLIM75 / PIANO COTTURA



UG Tartufo 72



UG Nero Matt 70

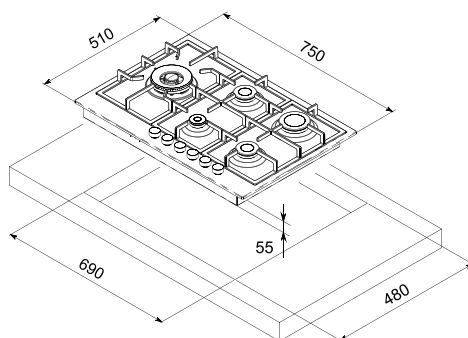

## COLORI DISPONIBILI

€ IVA  
esclusa



UG 70  
NERO MATT  
SLIM75 / 70

**790**



UG 72  
TARTUFO  
SLIM75 / 72

## DOTAZIONE

- Griglie in ghisa

## CARATTERISTICHE

- Piano cottura da 75 cm
- 5 fuochi gas di cui 1 tripla corona
- Comandi frontali
- Accensione elettronica sottomanopola
- Valvola di sicurezza
- Coprispartifiamma e griglie in ghisa
- Manopole color nero ghisa.
- Entrata GAS posteriore sinistra
- Foro per l'incasso: 690 x 480 mm

## ACCESSORI DISPONIBILI



Kit 5 manopole finitura  
cromo satinato  
**MAMOD75**

**35**

# FLAT75 / PIANO COTTURA



UM Alluminio 41



UG Bianco 98



UG Nero Matt 70



UG Tartufo 72



UM Alluminio 41



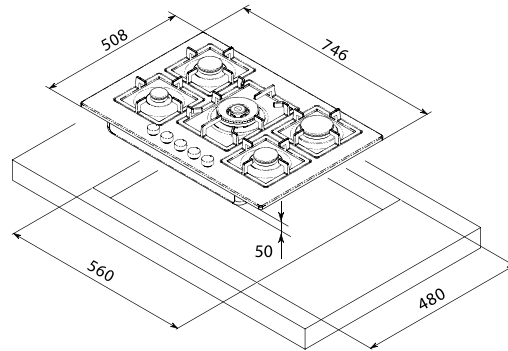

UM Titanio 42



## COLORI DISPONIBILI

€ IVA esclusa

-  UG 98  
BIANCO  
**FLAT75 / 98**
-  UG 70  
NERO MATT  
**FLAT75 / 70**
-  UG 72  
TARTUFO  
**FLAT75 / 72**

**710**

## COLORI DISPONIBILI

€ IVA esclusa

-  UM 41  
ALLUMINIO  
**FLAT75 / 41**
-  UM 42  
TITANIO  
**FLAT75 / 42**

**730**

## DOTAZIONE

- Griglie in ghisa

## CARATTERISTICHE

- Piano cottura da 75 cm
- 5 fuochi gas di cui 1 tripla corona
- Comandi frontali
- Accensione elettronica sottomanopola
- Valvola di sicurezza
- Coprispartifiamma e griglie in ghisa
- Manopole color nero ghisa.
- Entrata GAS posteriore sinistra
- Foro per l'incasso: 560 x 480 mm

## ACCESSORI DISPONIBILI



Kit 5 manopole finitura cromo satinato  
**MAMOD75**

**35**

# FLAT60 / PIANO COTTURA



UM Titano 42



UG Bianco 98



UG Nero Matt 70



UG Tartufo 72



UM Alluminio 41



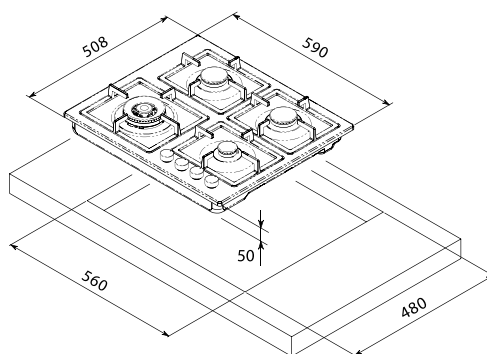

UM Titano 42



## COLORI DISPONIBILI

€ IVA esclusa

-  UG 98  
BIANCO  
**FLAT60 / 98**
-  UG 70  
NERO MATT  
**FLAT60 / 70**
-  UG 72  
TARTUFO  
**FLAT60 / 72**

**595**

## COLORI DISPONIBILI

€ IVA esclusa

-  UM 41  
ALLUMINIO  
**FLAT60 / 41**
-  UM 42  
TITANIO  
**FLAT60 / 42**

**615**

## DOTAZIONE

- Griglie in ghisa

## CARATTERISTICHE

- Piano cottura da 60 cm
- 4 fuochi gas di cui 1 tripla corona
- Comandi frontali
- Accensione elettronica sottomanopola
- Valvola di sicurezza
- Coprispartifiamma e griglie in ghisa
- Manopole color nero ghisa.
- Entrata GAS posteriore sinistra
- Foro per l'incasso: 560 x 480 mm

## ACCESSORI DISPONIBILI



Kit 4 manopole finitura cromo satinato  
**MAMOD60**

**28**

# STAR75 / PIANO COTTURA



## CONFIGURAZIONE CLASSICA:

**STAR75** Colore **UG Avena 94**  
con griglie in ghisa **GRGH175**  
e manopole anticate **MABR075**



UG 94 Avena



UG 70 Nero Matt

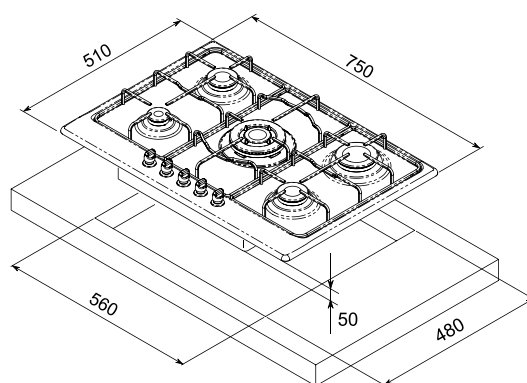

## COLORI DISPONIBILI

€ IVA  
esclusa



UG 70  
NERO MATT  
STAR75 / 70

**630**



UG 94  
AVENA  
STAR75 / 94

## DOTAZIONE

- Griglie smaltate

## CARATTERISTICHE

- Piano cottura da 75 cm
- 5 fuochi gas di cui 1 tripla corona
- Comandi frontali
- Accensione elettronica sottomanopola
- Valvola di sicurezza
- Coprispartifiamma e griglie in finitura smaltata
- Manopole nere
- Entrata GAS posteriore sinistra
- Foro per l'incasso: 560 x 480 mm

## ACCESSORI DISPONIBILI



Copri-spartifiamma  
e griglie in ghisa  
**GRGH175**

**165**



Kit 5 manopole finitura  
bronzo anticato  
**MABR075**

**63**



Kit 5 manopole finitura  
cromo satinato  
**MAM075**

**35**

# STAR60 / PIANO COTTURA



## CONFIGURAZIONE CLASSICA:

**STAR60** Colore **UG Avena 94**  
con griglie in ghisa **GRGH162**  
e manopole anticate **MABR060**



UG 94 Avena



UG 70 Nero Matt

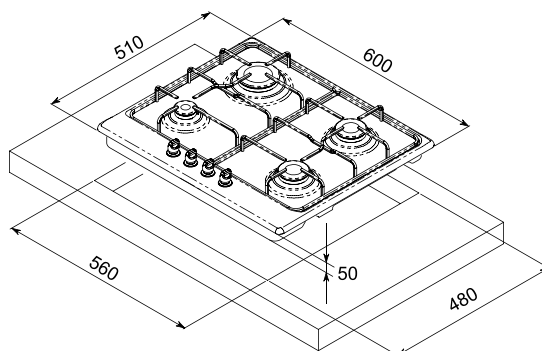

## COLORI DISPONIBILI

€ IVA  
esclusa

UG 70  
NERO MATT  
STAR60 / 70

490

UG 94  
AVENA  
STAR60 / 94

## DOTAZIONE

• Griglie smaltate

## CARATTERISTICHE

- Piano cottura da 60 cm
- 4 fuochi gas
- Comandi frontali
- Accensione elettronica sottomanopola
- Valvola di sicurezza
- Coprispartifiamma e griglie in finitura smaltata
- Manopole nere
- Entrata GAS posteriore sinistra
- Foro per l'incasso: 560 x 480 mm

## ACCESSORI DISPONIBILI

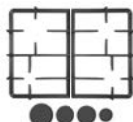

Copri-spartifiamma  
e griglie in ghisa  
**GRGH162**

125



Kit 4 manopole finitura  
bronzo anticato  
**MABR060**

53



Kit 4 manopole finitura  
cromo satinato  
**MAMOD60**

28

# ACCESSORI OPTIONAL PER PIANI COTTURA A GAS



## MAMOD75

Kit 5 manopole finitura cromo satinato.  
Compatibili con: GLASS75, SLIM75, FLAT75, STAR75.

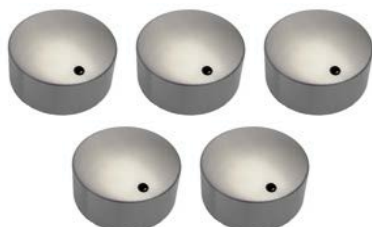

€ IVA  
esclusa

**35**

## MAMOD60

Kit 4 manopole finitura cromo satinato.  
Compatibili con: GLASS60, SLIM60, FLAT60, STAR60.



€ IVA  
esclusa

**28**

## MABR075

Kit 5 manopole finitura bronzo anticato per piano cottura STAR75.



€ IVA  
esclusa

**63**

## MABR060

Kit 4 manopole finitura bronzo anticato per piano cottura STAR60.



€ IVA  
esclusa

**53**

## GRGHI75

Kit copri-spartifiamma e griglie in ghisa per piano cottura STAR75.

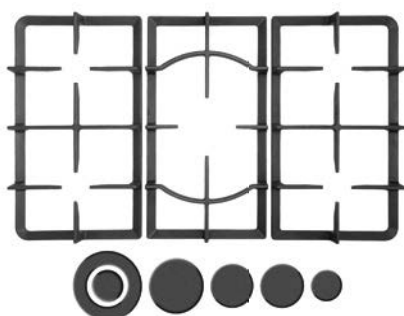

€ IVA  
esclusa

**165**

## GRGHI62

Kit copri-spartifiamma e griglie in ghisa per piano cottura STAR60.

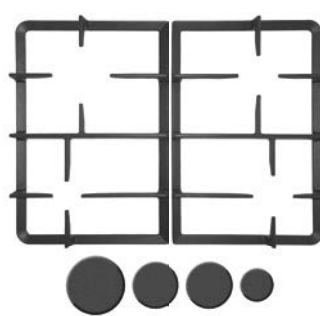

€ IVA  
esclusa

**125**

# GAMMA COLORI



È proprio nei colori che le proposte Plados trovano la massima espressione!

La nostra inimitabile gamma colori viene studiata e perfezionata di anno in anno al fine di garantire sempre un'offerta di colori aggiornata e di tendenza, migliorando di volta in volta le performances produttive e quindi i tempi di consegna dei lavelli.

# GAMMA COLORI



rinnova .....

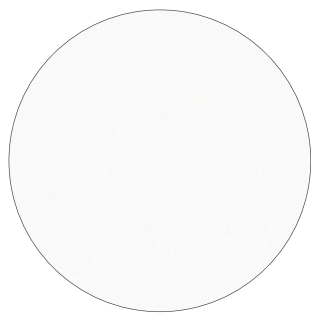

**R1 - ARCTIC WHITE**

Abbinabile con tutti i fabbricanti di elettrodomestici.



**R2 - DUNE BEIGE**

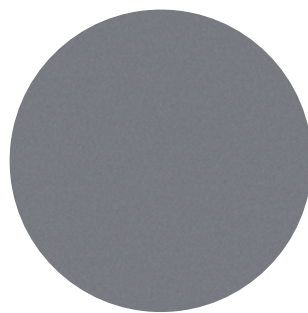

**R3 - ALP STONE**

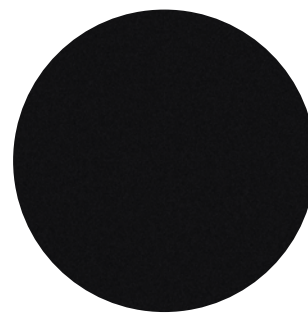

**R4 - VOLCANO BLACK**

Abbinabile con tutti i fabbricanti di elettrodomestici.



nanostone .....

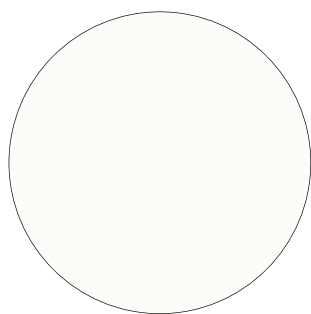

**N1 - BIANCO LATTE**

Abbinabile con tutti i fabbricanti di elettrodomestici.

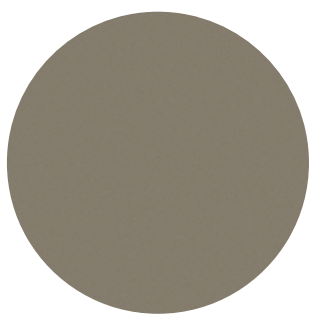

**N3 - ARGAN**

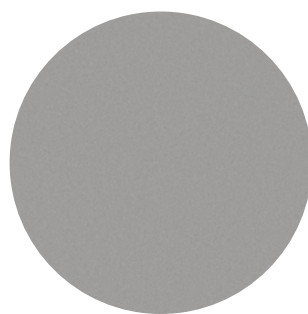

**N4 - URBAN GREY**

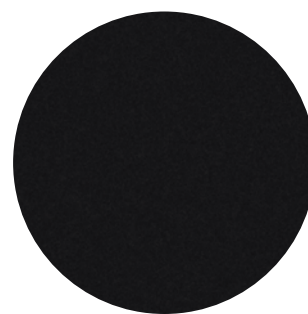

**N6 - DEEP BLACK**

Abbinabile con tutti i fabbricanti di elettrodomestici.



ultrametal .....



**41 - ALLUMINIO**

Abbinabile con: HOTPOINT-ARISTON (Argento SL), PLADOS, TELMA, SMEG, FRANKE, JOLLYNOX, SIEMENS, BOSCH.



**42 - TITANIO**

Abbinabile con: HOTPOINT-ARISTON, INDESIT, PLADOS, TELMA, JOLLYNOX, BOSCH, SIEMENS.



**14 - CONCRETE**



**44 - NERO**

Abbinabile con: HOTPOINT-ARISTON (Mirror MR), CANDY (Cristallo Nero), FRANKE, SIEMENS, BOSCH.



# GAMMA COLORI



## microultragranit



**56 - JASMINE**

Abbinabile con: HOTPOINT-ARISTON, REX/ELECTROLUX, CANDY, WHIRLPOOL, SMEG, NARDI, PLADOS, TELMA, FOSTER.

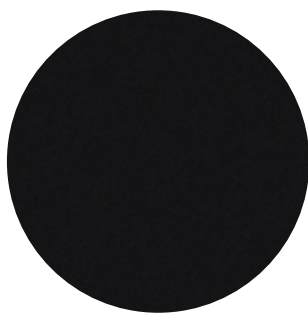

**70 - NERO MATT**

Abbinabile con tutti i fabbricanti di elettrodomestici.

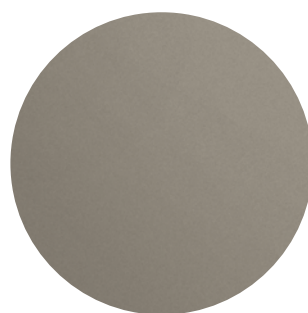

**72 - TARTUFO**

Abbinabile con: INDESIT, WHIRLPOOL, IGNIS, PLADOS, TELMA.



**90 - BIANCO OPALE**

Abbinabile con: HOTPOINT-ARISTON, REX/ELECTROLUX, CANDY, SMEG, NARDI, PLADOS, TELMA, FRANKE, JOLLYNOX.



**94 - AVENA**

Abbinabile con tutti i fabbricanti di elettrodomestici.



**95 - NERO EBONY**

Abbinabile con: REX/ELECTROLUX, CANDY, SMEG, NARDI, PLADOS, TELMA, FRANKE, JOLLYNOX.



**98 - BIANCO**

Abbinabile con tutti i fabbricanti di elettrodomestici.



## ultraquartz

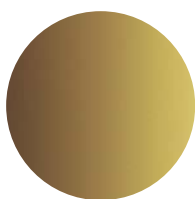

**66 - TERRA DI FRANCIA**

Abbinabile con tutti i fabbricanti di elettrodomestici.

## altre finiture

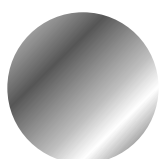

**40 - CROMO**

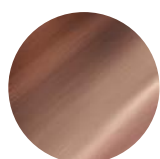

**17 - RAME ANTICATO**

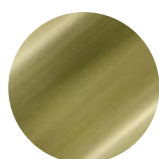

**18 - BRONZO ANTICATO**

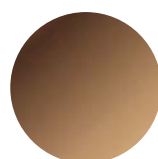

**PVD - RAME**



**PVD - ORO**



**PVD - GUN METAL**

# SERVIZI E ASSISTENZA

PLADOS È COSTANTEMENTE AL TUO FIANCO

## GARANZIA PLADOS

La durata della garanzia Plados varia a seconda dei materiali e della categoria del prodotto. Di seguito sono elencate le categorie e la rispettiva durata della garanzia.



lavelli  
**RINNOVA** e  
**nanoSTONE**



lavelli  
**ULTRAMETAL** e  
**microULTRAGRANIT**



lavelli  
**INOX**



miscelatori



elettrodomestici

**PER POTER USUFRUIRE DELLA GARANZIA SI RACCOMANDA DI CONSERVARE IL DOCUMENTO DI ACQUISTO.**

## ASSISTENZA PRE- VENDITA

I social network rappresentano per Plados un importante canale di interazione con i propri clienti. L'azienda è infatti contattabile attraverso le pagine Facebook, Instagram e LinkedIn, oltre che telefonicamente e via e-mail:



pladostelma



@pladostelma



pladostelma



Plados & Telma



[info@pladostelma.com](mailto:info@pladostelma.com)

## ASSISTENZA TECNICA **POST-VENDITA**

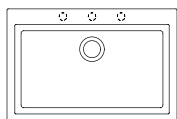

lavelli in composito

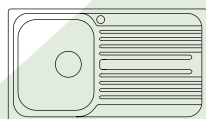

lavelli in acciaio inox

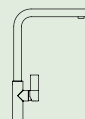

miscelatori

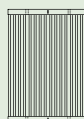

accessori

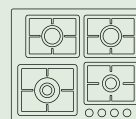

piani cottura a gas

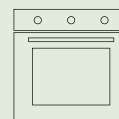

forni

PER RICHIEDERE ASSISTENZA SU LAVELLI IN MATERIALE COMPOSITO, IN ACCIAIO INOX, MISCELATORI, ACCESSORI, PIANI COTTURA A GAS, FORNI, PLADOS METTE A DISPOSIZIONE 3 MODALITÀ:



Chiama il nostro numero verde  
**dal lunedì al venerdì,  
dalle 9,30 alle 12,30  
e dalle 14 alle 17.**



Compila il modulo che trovi alla  
pagina **assistenza** del nostro  
sito **www.pladostelma.com**  
Rispondiamo entro 24 ore.



Scrivi un'e-mail a:  
**assistenza@pladostelma.com**  
Rispondiamo entro 24 ore.

IMPORTANTE! Per assistenza relativa ai LAVELLI, allegare all'e-mail la seguente documentazione:

- foto del prodotto con dettaglio del difetto/danneggiamento;
- foto dell'etichetta qualità posta sotto al lavello;
- codici del prodotto e del colore;
- documento fiscale.

PER RICHIEDERE ASSISTENZA SU CAPPE ASPIRANTI, PIANI COTTURA A INDUZIONE, DISSIPATORI, O PER LA RICHIESTA DI RICAMBI DIGITARE I NUMERI:

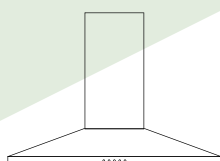

cappe aspiranti

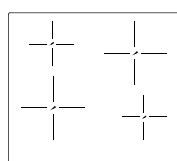

piani induzione

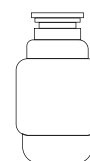

dissipatori



PER MAGGIORI INFORMAZIONI È POSSIBILE CONSULTARE LE F.A.Q. E LA SEZIONE ASSISTENZA SUL NOSTRO SITO **WWW.PLADOSTELMA.COM**



# CERTIFICAZIONI

PERCHÈ LA QUALITÀ DEI PRODOTTI  
NASCE DALLA QUALITÀ DEI  
PROCESSI PRODUTTIVI



ITALIAN  
TECHNOLOGY



GARANZIA  
FINO A 20  
ANNI



30 ANNI  
1991-2021



100% ECO  
COMPATIBILE



### **Marchio CE**

La certificazione di prodotto attesta che i prodotti sono conformi alle norme, direttive o disciplinari di settore e mette in evidenza la qualità, gli elementi di eccellenza e le peculiarità che li contraddistinguono. Tale processo di certificazione prevede lo svolgimento di prove iniziali di tipo sul prodotto, la valutazione iniziale, la successiva sorveglianza del processo produttivo ed infine, mediante test di laboratorio su campioni prelevati in fabbrica o sul mercato, la garanzia delle effettive prestazioni del prodotto rispetto alle norme di riferimento.

### **La Tracciabilità**

Al fine di assicurare la massima garanzia al consumatore, Plados ha attivato una procedura interna che consente all'azienda di risalire in qualsiasi momento al lotto di produzione dell'articolo e dei componenti utilizzati.



### **Azienda con sistema di gestione qualità certificato ISO 9001**

Le certificazioni definiscono i requisiti per l'implementazione di sistemi di gestione volti a condurre i vari processi aziendali in modo tale da migliorarne l'efficacia e l'efficienza, sia nelle fasi di realizzazione del prodotto che in quelle di erogazione del servizio, ottenendo ed incrementando la soddisfazione del cliente.



### **Imballaggi certificati**



### **Lavelli destinati al mercato U.S.A. certificati**



### **Elettrodomestici certificati**

Art Direction, Fotografia, Fotoritocco, Impaginazione:  
Reparto Grafica Plados S.p.A.

Immagini virtuali 3D: Zeen Visual

Altre immagini: freepik.com | vecteezy.com | pexels.com

Stampa: Tecnostampa S.r.l.

## **Condizioni generali di vendita**

La merce viaggia a rischio e pericolo del committente, anche se venduta franco destino.  
Trascorsi 5 giorni dal ricevimento della merce non si accettano reclami, né resi.

### **Imballo:**

In scatole di cartone comprese nel prezzo.

È stato fatto ogni sforzo per riprodurre colori e materiali accuratamente, tuttavia a causa dei processi di fotografia e stampa, potrebbero verificarsi delle alterazioni di colore. Ogni dato contenuto all'interno del catalogo generale Plados è da ritenersi esatto, salvo errori ed omissioni, per i quali la Plados S.p.A. non è in alcun modo responsabile. La Plados S.p.A. si riserva il diritto di modificare, in qualsiasi momento e senza preavviso, le caratteristiche tecniche, i colori ed i materiali di ogni prodotto presente nel catalogo. La disponibilità di tutti i modelli è soggetta a verifica da parte dell'azienda costruttrice. Il colore di tutti i prodotti presenti deve ritenersi puramente indicativo.













# INCASSO

INCASSO S.r.l.  
Via Cavalier Brunetto, 88 - Fraz. Ceretta - 10077 S. Maurizio C.se (TO)  
Tel. 011 9279570 r.a. - Fax 011 9279424  
E-mail: [incasso@incasso.it](mailto:incasso@incasso.it)  
[www.incasso.it](http://www.incasso.it)

DISTRIBUTORE AUTORIZZATO

# PLADOS

KITCHEN EXPERIENCE

PLADOS S.p.A.  
Via Grazia Deledda, 3 - 62010 Montecassiano (MC) ITALY  
Tel. +39 0733 290592 - Fax +39 0733 298070  
[info@pladostelma.com](mailto:info@pladostelma.com) - [www.pladostelma.com](http://www.pladostelma.com)