

# LISTINO 2024

PREZZI IVA ESCLUSA



**NOBILI**







## CONTENUTO

	FINITURE
26	BAGNO
284	CORPI INCASSO
336	DOCCIA
424	CUCINA
482	ARTICOLI VARI
534	PARTI DI RICAMBIO
548	INDICE ALFABETICO
586	CONDIZIONI GENERALI DI VENDITA
	ORGANIZZAZIONE COMMERCIALE

## ICONE

-  NOVITÀ
-  MODIFICATO\*
-  CARTUCCIA GARANTITA 20 ANNI

## RICAMBI PRINCIPALI

-  CARTUCCIA
-  CARTUCCIA TERMOSTATICA
-  CARTUCCIA DEVIATRICE
-  VITONE
-  DISPOSITIVO ANTIREFLUSSO
-  AERATORE (Finitura Cromo lucido)
-  PROLUNGA (Finitura Cromo lucido)
-  CIUFFO SCOPINO

## RICAMBI COMPLETI

-  [NOBILI.IT / AREA CLIENTI / B2B](#)

\*Articolo soggetto a modifiche, di dettaglio o sostanziali, nel corso dell'anno. Prima della stesura dell'ordine consigliamo di consultare la nostra rete vendita o l'assistenza clienti.





## BUON LAVORO!

Conoscere i nostri modelli permette di apprezzarne al meglio l'avanguardia: inquadra con il tuo dispositivo (tablet o smartphone) i QR Code riportati di seguito, sarai trasportato nell'universo digitale del nostro brand e accederai in modo semplice ed immediato ad approfondimenti esclusivi sulle nostre linee di prodotto.



### BAGNO

La nostra gamma per la sala da bagno è caratterizzata da una forte identità stilistica, da un altissimo livello di qualità progettuale e produttiva, e da una marcata focalizzazione sui temi dell'ergonomia e dell'efficienza funzionale, quali il risparmio idrico ed energetico.



### ACCESSORI

Perfettamente coordinati allo stile e alle finiture della rubinetteria bagno, disponiamo di svariate linee di accessori dalla gamma ampia e completa, in grado di aiutare la progettazione dello spazio architettonico curandone con armonia ed eleganza l'intero aspetto.



### DOCCIA

Sinonimo di benessere psicofisico, dedichiamo continue risorse per individuare soluzioni in grado di migliorare la qualità della vita. Ci impegniamo a velocizzare le procedure di installazione, pensando a sistemi pratici ed universali, utili laddove il fattore tempo costituisce un valore rilevante.



### CUCINA

Dedichiamo a questo settore un grande impegno, sia per quanto concerne le valenze estetiche che per la definizione degli aspetti funzionali, e mettiamo a disposizione della clientela, produttori di cucine, architetti e interior designer, una gamma pressochè infinita di soluzioni.



### CATALOGHI

Una letteratura informativa più curata e distintiva, dedicata alle collezioni dallo stile più iconico e ricercato, è affiancata da una depliantistica più snella e immediata, riservata alle collezioni caratterizzate da linee più semplici e adatte alla quotidianità.













### Q CERCA UN PRODOTTO O UN RICAMBIO

Individua con estrema velocità il modello che stai cercando, filtrando l'intera gamma per categoria oppure inserendo direttamente il codice articolo o una descrizione testuale: accederai all'esplosione del prodotto con l'elenco di tutte le parti di ricambio disponibili.

# FINITURE

Personalità differenti delineate dal sodalizio perfetto tra forma e sfumatura. Svariate tonalità per accrescere il carattere delle singole collezioni: attraverso gli abbinamenti proposti, il Cliente è accompagnato verso la soluzione stilistica più idonea in grado di valorizzare al meglio l'intero ambiente.

	 <b>CR</b> CROMO LUCIDO	 <b>IX</b> INOX SPAZZOLATO	 <b>GUP</b> GRAFITE SPAZZOLATO <small>PVD</small>	 <b>BM</b> MORA OPACO	 <b>WM</b> NEVE OPACO	 <b>CGP</b> MIELE SPAZZOLATO <small>PVD</small>	 <b>GTP</b> AMBRA SPAZZOLATO <small>PVD</small>	 <b>SB</b> CAFFÈ SPAZZOLATO	 <b>RCP</b> TRAMONTO LUCIDO <small>PVD</small>	 <b>RTP</b> ARGILLA SPAZZOLATO <small>PVD</small>
<b>RUBINETTERIA BAGNO</b>										
SOLE	•	•	•					•		•
VELIS	•	•	•			•		•		•
DRESS	•	•								
LIKID	•									
LIVE	•	•	•	•	•	•				•
ACQUERELLI	•	•		•						•
UNO	•			•						
YOYO	•			•						
SEVEN	•	•		•						•
ACQUAVIVA	•			•						
LOOP	•									
UP	•			•						
RAY	•									
MIA	•	•		•						
SOFI	•						•			
LIRA	•		•	•						
CARLOS PRIMERO	•					•	•			
GRAZIA	•					•				
BLUES	•									
ABC	•			•						
NOBI	•									
SAND	•									
SKY	•									
NEW ROAD	•									
<b>RUBINETTERIA CUCINA</b>										
SORGENTE	•	•	•	•			•			•
LEVANTE	•	•		•						
MOVE	•	•		•						
HERON	•	•								
LAMP	•	•		•						
YPSILON	•	•								
FLAT	•									
MASTER	•	•								
MANIA	•		•	•			•			•
FLAG	•	•		•						
GIORNO	•		•				•			•
VELIS	•	•								
LIVE	•	•		•	•					
ACQUERELLI	•	•	•				•			
MIA	•	•								
CHARLIE	•						•			•
GRAZIA	•									
ANTICA	•						•			•
MATCH	•	•		•						
SNOW	•	•		•						
DISPENSER SAPONE	•	•	•	•			•			•



## BUON LAVORO!

Conoscere i nostri modelli permette di apprezzarne al meglio l'avanguardia: inquadra con il tuo dispositivo (tablet o smartphone) i QR Code riportati di seguito, sarai trasportato nell'universo digitale del nostro brand e accederai in modo semplice ed immediato ad approfondimenti esclusivi sulle nostre linee di prodotto.



### BAGNO

La nostra gamma per la sala da bagno è caratterizzata da una forte identità stilistica, da un altissimo livello di qualità progettuale e produttiva, e da una marcata focalizzazione sui temi dell'ergonomia e dell'efficienza funzionale, quali il risparmio idrico ed energetico.



### ACCESSORI

Perfettamente coordinati allo stile e alle finiture della rubinetteria bagno, disponiamo di svariate linee di accessori dalla gamma ampia e completa, in grado di aiutare la progettazione dello spazio architettonico curandone con armonia ed eleganza l'intero aspetto.



### DOCCIA

Sinonimo di benessere psicofisico, dedichiamo continue risorse per individuare soluzioni in grado di migliorare la qualità della vita. Ci impegniamo a velocizzare le procedure di installazione, pensando a sistemi pratici ed universali, utili laddove il fattore tempo costituisce un valore rilevante.



### CUCINA

Dedichiamo a questo settore un grande impegno, sia per quanto concerne le valenze estetiche che per la definizione degli aspetti funzionali, e mettiamo a disposizione della clientela, produttori di cucine, architetti e interior designer, una gamma pressochè infinita di soluzioni.



### CATALOGHI

Una letteratura informativa più curata e distintiva, dedicata alle collezioni dallo stile più iconico e ricercato, è affiancata da una depliantistica più snella e immediata, riservata alle collezioni caratterizzate da linee più semplici e adatte alla quotidianità.



### Q CERCA UN PRODOTTO O UN RICAMBIO

Individua con estrema velocità il modello che stai cercando, filtrando l'intera gamma per categoria oppure inserendo direttamente il codice articolo o una descrizione testuale: accederai all'esplosione del prodotto con l'elenco di tutte le parti di ricambio disponibili.

## LA NOSTRA CASA

Il NIT (Nobili Industria Tecnologica), in provincia di Novara, è il complesso più razionale ed efficiente dell'intero settore, progettato sulla base di un layout pensato per supportare un processo di crescita costante e per offrire al mercato uno standard qualitativo estremamente elevato e con un impatto ambientale ridottissimo.







## REALTÀ UNICA

Siamo l'unica azienda europea del settore con il ciclo produttivo totalmente integrato, leader per ricerca e, soprattutto, per il livello di evoluzione tecnologica degli apparati produttivi: 452 centri di lavoro dislocati su un'area di 88.000 mq, per un totale di 2,8 milioni di articoli venduti all'anno.



### FONDERIA

Una delle aree che, insieme alla torneria, rappresenta il momento dove tutto prende forma: il reparto Fonderia robotizzato a bassa pressione, dove al suo interno 20 centri di lavoro realizzano ogni anno oltre 780.000 componenti, riducendo a zero lo scarto di materiale e nel più totale rispetto ambientale.



### LAVORAZIONI MECCANICHE

120 impianti realizzano oltre 28 milioni di componenti all'anno partendo da una barra d'ottone, senza sprechi e nel pieno rispetto ambientale: tutte le fasi sono controllate da un sistema elettronico che garantisce la precisione assoluta, elemento imprescindibile per arredare le abitazioni e gli hotel più prestigiosi del mondo.

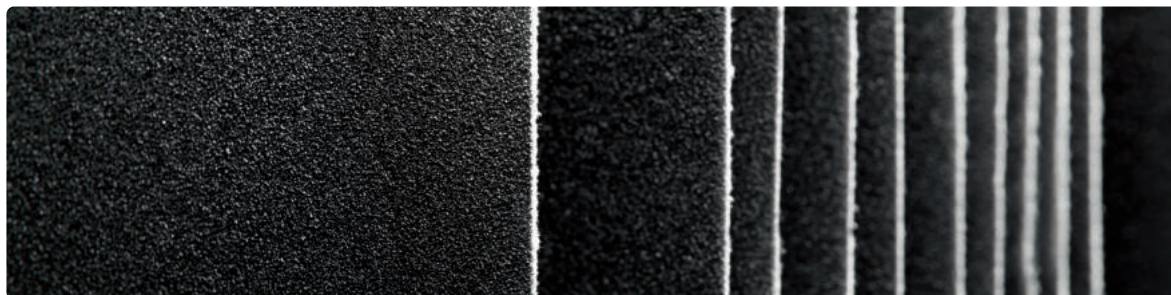

### PULITURA

Successivamente, i componenti passano ad un accurato lavaggio e successivamente al reparto Pulitura: in quest'area 110 postazioni totalmente automatizzate lavorano oltre 6 milioni di componenti all'anno, coordinando l'automazione dei robot alla grande esperienza degli operatori dedicati.





#### STAMPAGGIO MATERIALI TERMOPLASTICI

Le componenti plastiche svolgono un ruolo fondamentale: in particolare la cartuccia, realizzata utilizzando plastiche a miscela alimentare prive di componenti tossiche. Un reparto d'eccellenza che si avvale di 18 presse, e lavora oltre 15 milioni di componenti all'anno, senza sosta (24 ore su 24) e senza sprechi.



#### TRATTAMENTI SUPERFICIALI

Le migliori attrezzature e le più avanzate risorse tecnologiche disponibili, al fine di realizzare una finitura lucida e brillante, e per garantire la più ampia sostenibilità, grazie ad un totale controllo nella gestione delle sostanze impiegate: il modo migliore per tutelare l'ambiente e la salute degli operatori.



#### ASSEMBLAGGIO

L'assemblaggio inizia dal cuore del miscelatore, dove ogni giorno sono confezionate una media di 10.000 cartucce. 2.600.000 articoli all'anno vengono assemblati sulle 23 linee di montaggio, affiancate da 20 postazioni laser per la marcatura, che intervengono dopo che il prodotto ha superato tutti i test di qualità.

## SUNO DOMANI

L'architetto Maria Grazia Nobili e l'interior designer Alice Cristina stanno definendo gli ultimi dettagli del progetto di una palazzina di grande qualità architettonica: la struttura sarà dotata di un'area ristoro, sale meeting di varie metrature, uno splendido showroom e un nuovo e moderno laboratorio prove e controllo qualità.

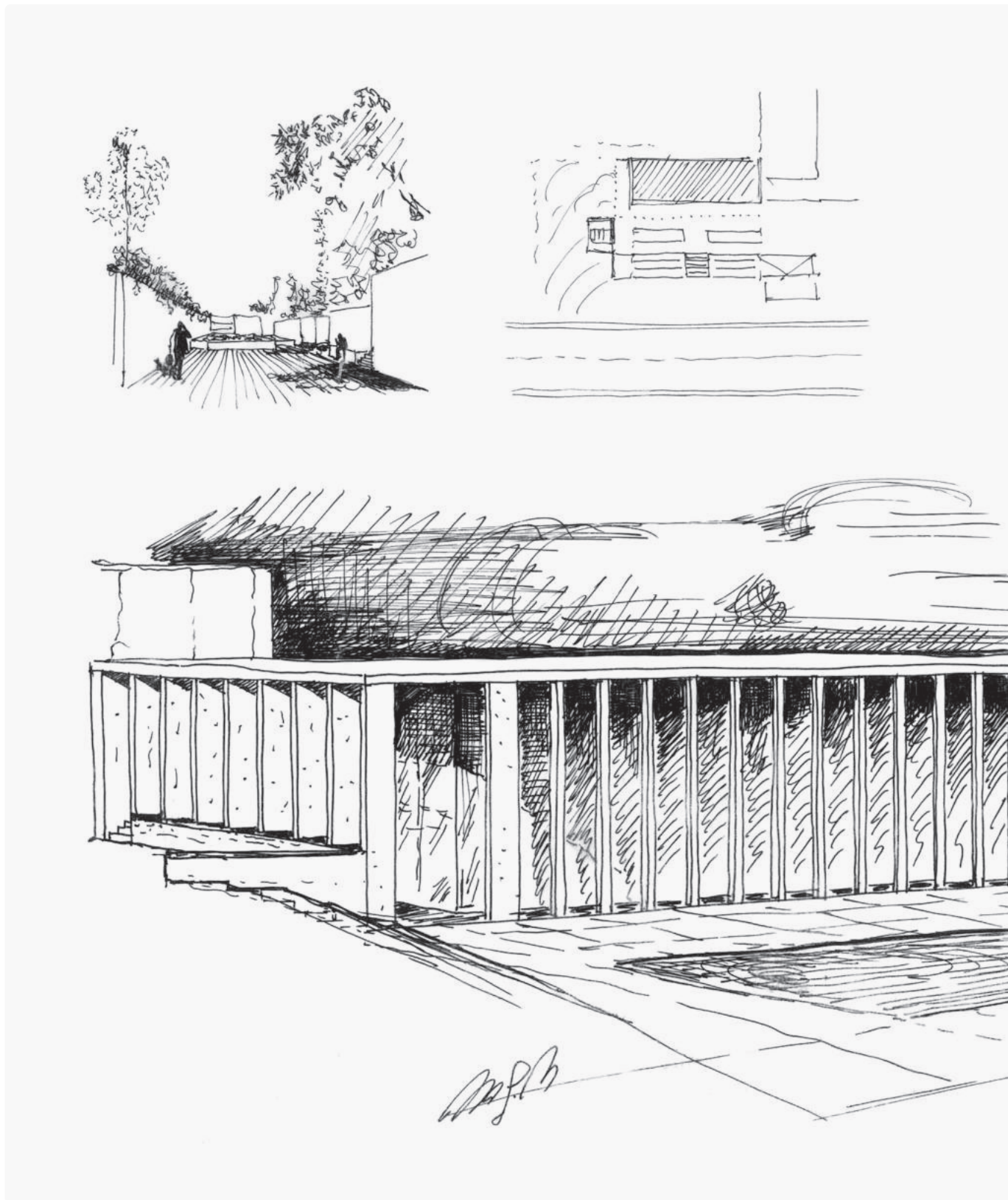



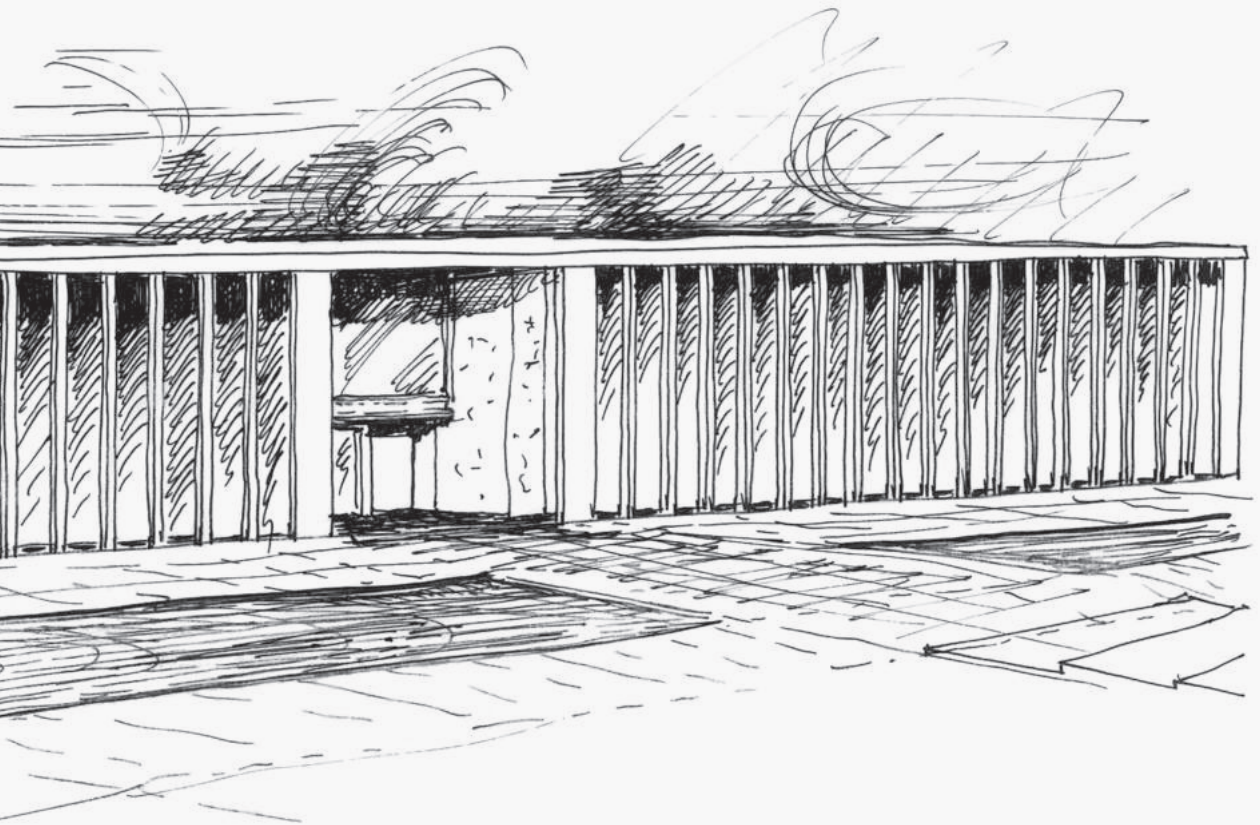
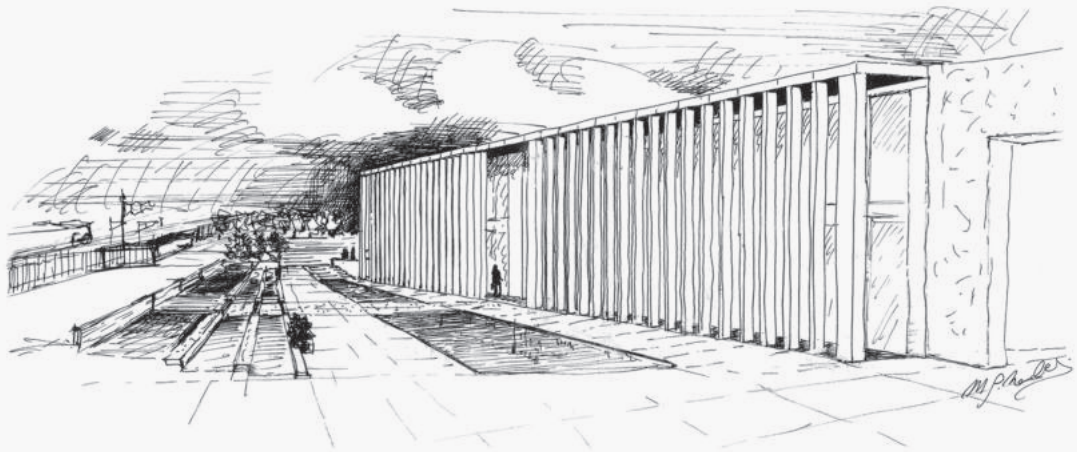

## CERTIFICAZIONI INTERNAZIONALI

Ogni miscelatore Nobili è progettato e realizzato all'interno dei nostri reparti: dovrà rispondere alle più severe normative internazionali, garantendo massima qualità, sicurezza e rispetto ambientale. Per maggiori informazioni invitiamo a consultare i siti ufficiali delle varie certificazioni o a scrivere all'indirizzo mail: [qualita@nobili.it](mailto:qualita@nobili.it)



NF

Rilasciata dal laboratorio CSTB, certificazione francese leader in Europa, attesta la conformità di prodotti e servizi alle normative internazionali.



ACS

Sviluppato dalle autorità sanitarie francesi, valuta l'idoneità di un prodotto in contatto con acqua destinata al consumo umano.



WATERMARK

Per l'Australia e la Nuova Zelanda, la certificazione WaterMark Sai Global prevede test sugli elementi dei sistemi di conduzione.



DVGW

Si rivolge alle aziende che realizzano prodotti a contatto con acqua potabile, per supportarli nell'immissione nel mercato tedesco.



SINTEF

Contribuisce a garantire la qualità, i valori e la tutela dell'ambiente attraverso schemi di approvazione e certificazione basati su norme internazionali.



ETA

ETA Danmark rilascia approvazioni MK per materiali e costruzioni e approvazioni VA per attrezzature idriche e di drenaggio.

The logo for KIWA, featuring the word "kiwa" in a bold, lowercase, blue sans-serif font.

KIWA

Ente di Qualità internazionale che supporta le aziende nella loro crescita: la certificazione è dedicata ad alcuni modelli di cartucce di miscelazione.



BELGAQUA

Associazione professionale che raggruppa le tre associazioni regionali che rappresentano il settore idrico in Belgio.



SVGW

Dal 1873 la società Svizzera SSIGA contribuisce all'approvvigionamento sicuro e sostenibile di gas, calore e acqua potabile.



PZH

Nata come base scientifica, l'Istituto nazionale di sanità pubblica PZH - PIB è la più antica istituzione sanitaria pubblica in Polonia.



CSA GROUP

CSA Group è un'organizzazione globale dedicata al miglioramento della vita attraverso il progresso degli standard nei settori pubblico e privato.



UNIFIED WATER LABEL

Identifica i prodotti che utilizzano acqua attraverso un'etichetta chiara, concisa e di facile comprensione, rivolta al consumo di acqua ed energia.

## AFFIDABILITÀ TOTALE

Il nostro prodotto esprime la massima innovazione tecnologica al servizio della qualità della vita e del rispetto ambientale. Racconta l'utilizzo di materiali di prim'ordine lavorati attraverso processi all'avanguardia: per questo siamo orgogliosi di garantire le nostre cartucce Nobili Widd® da 28 e 35 millimetri per un periodo di ben 20 anni.







#### ASTINA IN OTTONE

L'astina di movimentazione è realizzata in ottone, anziché in materiale plastico, e garantisce la migliore robustezza e affidabilità nel tempo.



#### LIMITATORE DI PORTATA

L'inserto posizionato sulla parte superiore dell'astina permette di ridurre il consumo d'acqua frenando l'apertura a metà corsa.



#### LIMITATORE DI TEMPERATURA

Una ghiera ruotabile permette di scegliere la temperatura massima erogata dal miscelatore, diminuendo il consumo di acqua calda.



#### PIASTRINE IN CERAMICA

Le piastrelle in pura ceramica migliorano l'affidabilità e consentono una morbidezza dei movimenti della leva senza uguali.



#### ULTEM™ 2200

Utilizziamo Ultem™ 2200, un polimero plastico caricato con fibra di vetro al 20% che dona una maggiore rigidità, elasticità e resistenza.



#### RIDUTTORE DI PORTATA

Disponibile su richiesta, permette di scegliere la portata massima del miscelatore, indipendentemente dall'aeratore e dalla pressione d'arrivo dell'acqua.

## RICERCATA SEMPLICITÀ

Ricerca semplicità, inedite proporzioni in grado di stravolgere le logiche più tradizionali. Sole rappresenta la perfetta sintesi tra tecnologia e stile, un connubio in grado di dare vita ad un miscelatore unico, che non annoia mai grazie alla sua estrema essenzialità: complesso da costruire, semplice da vivere.





CARTUCCIA NOBILI WIDD® 2020

Rivoluziona la struttura dei miscelatori tradizionali eliminando il blocco cartuccia laterale e dando vita ad una linea estremamente pulita e filante.



APERTURA IN ACQUA FREDDA

L'apertura dell'erogazione in acqua fredda evita l'accensione involontaria della caldaia e l'immissione di anidride carbonica nell'atmosfera.



AERATORE NEOPERL® CON PORTATA 5 L/MIN

Sole monta di serie l'aeratore Neoperl® con portata ridotta a 5 litri al minuto: garantisce un flusso corposo e al contempo risparmio idrico.



GAMMA COMPLETA

La gamma Sole copre tutte le aree della sala bagno: lavabo, vasca e zona doccia, tra cui diversi componenti dal design dedicato.



FINITURE SPAZZOLATE

Oltre alla più classica finitura Inox, l'intera gamma Sole è disponibile in altre tre tonalità spazzolate: Grafite PVD, Caffè, Argilla PVD.



ACCESSORI COORDINATI

Disponibili in tutte le finiture di Sole, gli accessori Zen mantengono ordine nella sala da bagno, dando vita ad atmosfere moderne ed eleganti.

## PURO MINIMALISMO

Puro minimalismo, pura tecnologia, pura libertà. Velis elimina il superfluo e torna all'essenziale, attraverso una linea moderna e senza tempo: la cartuccia a immersione totale Nobili Widd® nella sua versione più recente con miscelazione assiale permette un inedito e straordinario equilibrio tra stile e avanguardia.







CARTUCCIA NOBILI WIDD® 2020

Rivoluziona la struttura dei miscelatori tradizionali eliminando il blocco cartuccia laterale e dando vita ad una linea estremamente pulita e filante.



APERTURA IN ACQUA FREDDA

L'apertura dell'erogazione in acqua fredda evita l'accensione involontaria della caldaia e l'immissione di anidride carbonica nell'atmosfera.



AERATORE NEOPERL® CON PORTATA 5 L/MIN

Velis monta di serie l'aeratore Neoperl® con portata ridotta a 5 litri al minuto: garantisce un flusso corposo e al contempo risparmio idrico.

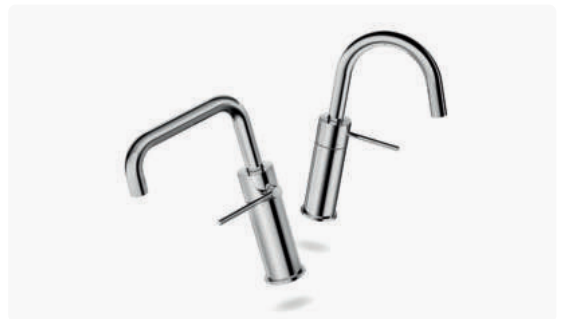

DOPPIA PERSONALITÀ

Velis è disponibile con due varianti di bocca di erogazione, entrambe declinate in tutte le finiture della collezione.

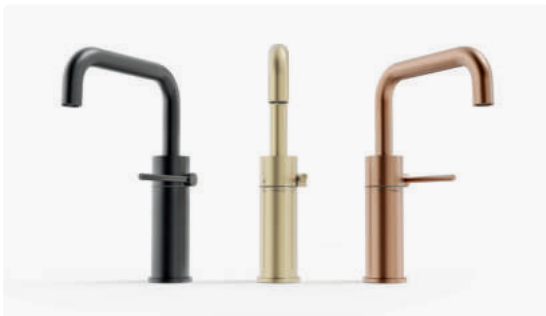

FINITURE PVD SPAZZOLATO

Velis è disponibile in tre finiture PVD spazzolato, antigraffio e antiusura, in grado di accentuare la sua marcata personalità: Grafite, Miele e Argilla.



ACCESSORI COORDINATI

Disponibili in tutte le finiture di Velis, gli accessori Zen mantengono ordine nella sala da bagno, dando vita ad atmosfere moderne ed eleganti.

## SOSTENIBILITÀ QUOTIDIANA

Sand, così come tutte le linee Living, promuove una filosofia a impatto zero per l'ambiente, nel segno del massimo risparmio idrico ed energetico: l'aeratore con portata limitata a 5 litri al minuto è abbinato all'apertura in acqua fredda, in grado di evitare l'accensione della caldaia e l'immissione di fumi di combustione nell'atmosfera.





CARTUCCIA GARANTITA 20 ANNI

La cartuccia a immersione Nobili Widd® permette livelli di affidabilità inimmaginabili: rottura in torsione 18 Nm, resistenza alta pressione oltre 70 Bar.



APERTURA IN ACQUA FREDDA

L'apertura dell'erogazione in acqua fredda azzerava le emissioni di anidride carbonica derivate dall'accensione involontaria della caldaia.



AERATORE CON PORTATA 5 L/MIN

L'aeratore Neoperl® Cascade® con portata limitata a 5 litri al minuto, il modo più semplice e veloce per contribuire alla salvaguardia del Pianeta.



SCARICO LAVABO SNAP

Altamente performante, permette un bloccaggio anti svitamento, è regolabile senza l'utilizzo di utensili, anti vandalo e anti inclinazione.



FLESSIBILI NPI ITALIA PARINOX® SOFTPEX®

Approvato in tutto il mondo grazie alle proprietà igieniche interne, alla resistenza a temperatura e pressione e alla maggiore flessibilità.



ANELLO DI GUIDA

Un anello di guida garantisce un perfetto centraggio del rubinetto nel foro della ceramica, semplificandone e velocizzandone il montaggio.

## UNIVERSALE, INTELLIGENTE E VERSATILE

Il termostatico incasso Wellbox è sinonimo di avanguardia tecnologica: il blocco di sicurezza interrompe l'erogazione in caso di improvvisa mancanza di acqua fredda, può essere installato su cartongesso sia in verticale che orizzontale, ed è predisposto per il collegamento delle tubature sul lato sinistro o destro.

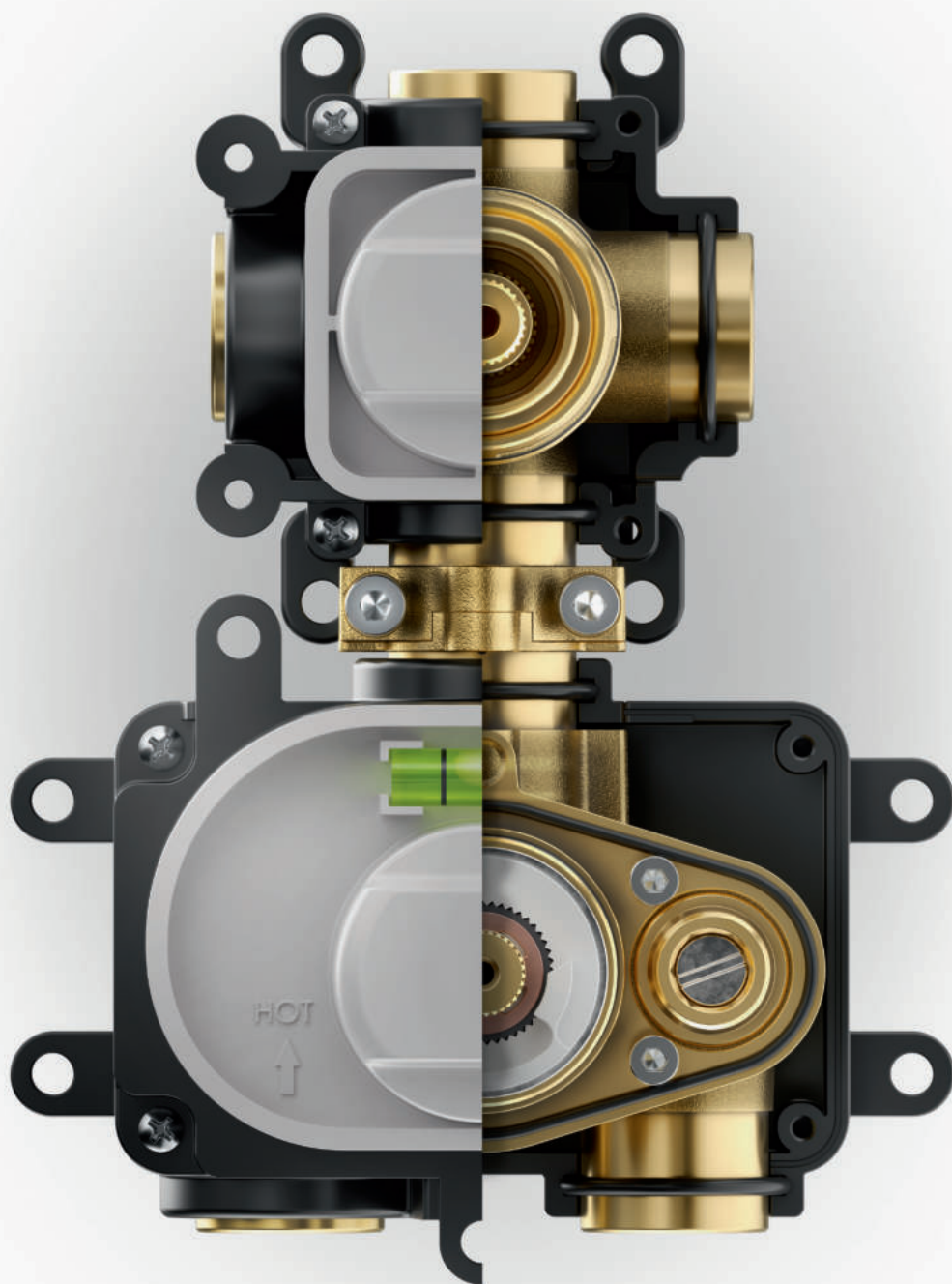





CARTUCCIA NOBILI THERMOTECH®

Aumenta la velocità di miscelazione dell'acqua e riduce nettamente il tempo di risposta al cambiamento improvviso di temperatura.



TAPPI DI PROTEZIONE CON BOLLA INTEGRATA

Proteggono le parti meccaniche interne, mentre la bolla integrata consente una rapida e precisa installazione del corpo incasso.



SCATOLA PLURIFUNZIONE

Fornisce una sigillatura perfetta e insonorizzata, è dotata di asole per l'installazione su cartongesso e in caso di errore di montaggio può essere tagliata.



RUBINETTI DI ARRESTO INTEGRATI

Due valvole di arresto dotate di filtro permettono di eseguire la manutenzione ordinaria senza dover chiudere il rubinetto centrale del bagno.

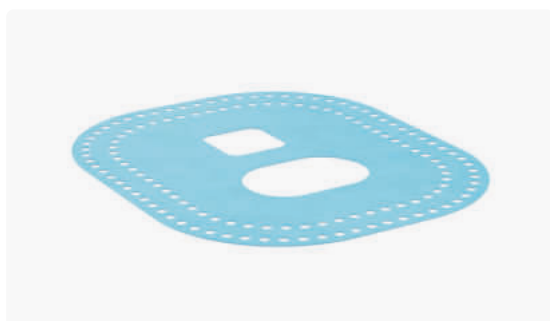

GUARNIZIONE DI TENUTA

Una membrana impermeabilizzante a tre strati, da posizionare tra la colla e la piastrellatura, aumenta le performance tecniche del prodotto.



LIBERTÀ DI SCELTA

Totale libertà di scelta, sia per quanto riguarda il design che per la finitura della parte estetica, anche dopo che l'impianto è stato terminato.

## ZEN HARMONY

Plain, una scelta estetica dedicata alla più pura esperienza benessere: il grande piano d'appoggio in vetro, assoluto protagonista della scena, permette di mantenere ordine ed eleganza all'interno dello spazio doccia. La totale aderenza alla parete sottolinea l'attenzione al dettaglio, nascosta in un design estremo e ricercato.





#### SEMPLICITÀ FUNZIONALE

Il grande piano d'appoggio (300 x 130 mm) permette di tenere a portata di mano tutti gli accessori dedicati al benessere, mantenendo ordine nella doccia.



#### RIFLESSI DI STILE

La lastra in vetro temperato antigraffio accentua il gioco di riflessi della superficie cromata: è disponibile in due colorazioni, bianco oppure nero.



#### EFFICIENZA TERMOSTATICA

La manopola di sinistra nasconde il pulsante di sicurezza della cartuccia termostatica Nobili Thermotech® con blocco della temperatura a 38°C.

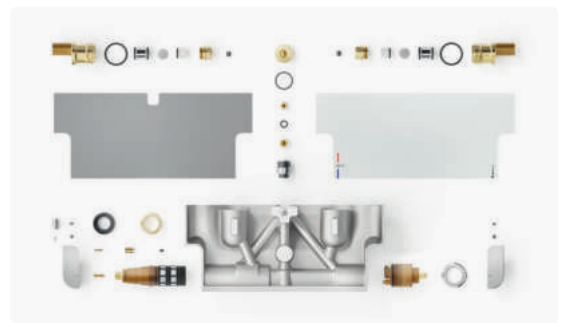

#### AVANGUARDIA COSTRUTTIVA

Il corpo di Plain è lavorato dal pieno all'interno del Nobili Technology Centre, il complesso produttivo più avanzato ed efficiente dell'intero settore.



#### COMPLETEZZA DI GAMMA

Il soffione XL (400 x 270 mm) della colonna doccia termostatica Plain riprende i canoni stilistici del miscelatore ed assicura un comfort immediato.



#### COMFORT ELEVATO

La doccetta a 3 getti di grandi dimensioni (diametro 120 mm) è dotata di comando a pulsante integrato nella parte superiore dell'impugnatura.

## MERAVIGLIA IN OGNI GOCCIA

Trasforma l'acqua della tua rete idrica! A seconda dei modelli, i sistemi Nobili Sorgente (Filtra, Frizza e Frizza & Bolle) permettono di disporre istantaneamente di acqua corrente miscelata, acqua bollente a 99 °C e tre tipologie di acqua filtrata: temperatura ambiente, refrigerata, refrigerata frizzante.







### SORGENTE BOLLE

Il boiler in acciaio è abbinato al filtro Gioia: migliora la qualità dell'acqua mantenendo un corretto equilibrio minerale e riduce la presenza di metalli pesanti.



### ACQUA BOLLENTE Istantanea

Acqua corrente miscelata e acqua bollente istantanea a 99 °C, risparmiando tempo in tutte le attività di cucina che richiedono acqua a questa temperatura.



### SORGENTE FRIZZA

Il dispositivo sottolavello riunisce tutto il necessario mantenendo ingombri contenuti e permettendo di lasciare spazio libero all'interno del cabinet.



### L'ACQUA CHE HAI SEMPRE DESIDERATO

Acqua corrente miscelata e tre tipologie di acqua filtrata: temperatura ambiente, refrigerata, refrigerata frizzante.



### SORGENTE FRIZZA & BOLLE

Il segreto di un miscelatore così performante è tutto all'interno di un solo dispositivo dagli ingombri contenuti e dalle prestazioni di altissimo livello.



### SONO IL TUO SOUS CHEF!

Acqua corrente miscelata, acqua bollente a 99 °C e tre tipologie di acqua filtrata: temperatura ambiente, refrigerata, refrigerata frizzante.

## LIGURIAN FLAVOUR

L'indole intuitiva di Levante evoca comfort e semplicità di utilizzo. L'ampio raggio d'azione della doccetta, collocata in posizione opposta rispetto ai miscelatori tradizionali, unito alla facilità di prelevarla con una sola mano in virtù dell'ancoraggio magnetico, permettono la più totale libertà di movimento sul piano lavello.





#### CARTUCCIA GARANTITA 20 ANNI

La cartuccia a immersione Nobili Widd® dal diametro di appena 28 millimetri, garantita 20 anni, aiuta ogni giorno a risparmiare acqua ed energia.



#### APERTURA IN ACQUA FREDDA

L'apertura dell'erogazione in acqua fredda evita l'accensione involontaria della caldaia e l'immissione di anidride carbonica nell'atmosfera.



#### ROTAZIONE ANTERIORE

L'inedita posizione anteriore del centro di rotazione della doccetta permette di raddoppiare il raggio d'azione del miscelatore.



#### AGGANCIO MAGNETICO

L'appoggio e la tenuta della doccetta a due getti sono regolate da un potente magnete, consentendo di prelevarla e utilizzarla con una sola mano.



#### MANOPOLA ERGONOMICA

La manopola di Levante riprende lo stile del corpo lavello: la forma allungata migliora l'ergonomia e la leggerezza dei movimenti.







































#### TAMPOGRAFIE ESCLUSIVE

Dettagli curati ed esclusivi: la manopola è impreziosita dal logo del miscelatore e dalle indicazioni acqua calda e fredda di nuovo design.

# BAGNO

I prodotti dedicati alla sala da bagno comprendono rubinetteria "Nobili", dedicata all'architetto e caratterizzata da una forte identità stilistica, e rubinetteria "Enne di Nobili", contraddistinta da una marcata focalizzazione sui temi dell'efficienza funzionale. Diverse linee di accessori completano la progettazione dello spazio architettonico.

## RUBINETTERIA NOBILI

	<b>SOLE</b> <span style="background-color: green; color: white; padding: 2px;">NEW</span> 29			<b>ACQUAVIVA</b> 135	
	<b>VELIS</b> 43			<b>LOOP</b> 141	
	<b>DRESS</b> 65			<b>UP</b> 155	
	<b>LIKID</b> 75			<b>RAY</b> 165	
	<b>LIVE</b> 81			<b>MIA</b> 175	
	<b>ACQUERELLI</b> 97			<b>SOFI</b> 187	
	<b>UNO</b> 103			<b>LIRA</b> 197	
	<b>YOYO</b> 113			<b>CARLOS PRIMERO</b> 207	
	<b>SEVEN</b> 123			<b>GRAZIA</b> 215	



RUBINETTERIA ENNE DI NOBILI

**BLUES**  
223



**ABC**  
229



**NOBI**  
239



**SAND**  
243



**SKY**  
247



**NEW ROAD**  
255





ACCESSORI

**ZEN**  
265



**TODAY**  
273



**NEOCLASSIC**  
279



RUBINETTERIA NOBILI

# SOLE

Centro Stile Nobili

Linee dirompenti, ispirate all'archetipo del tubo e al mondo delle chiusure idrauliche industriali, originale sintesi di design e innovazione tecnologica: in Sole, la miscelazione assiale nella sua forma più evoluta permette di posizionare la manopola di comando all'estremità della bocca di erogazione. Un progetto reso possibile dalla cartuccia più innovativa di sempre, Nobili Widd® 2020, in grado di pulire le linee del miscelatore e migliorarne l'efficienza.



Inox spazzolato



Grafite spazzolato PVD



Caffè spazzolato



Argilla spazzolato PVD

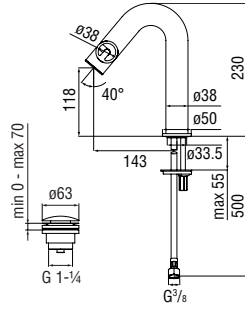

Cromo lucido

**Monocomando**

- Limitatore di energia con apertura in acqua fredda
- Aeratore anticalcare M 18,5 x 1, portata 5 l/min
- Scarico 1 1/4" push
- Flessibili inox ø 3/8"

Inox spazzolato	SOI30118/2IX	<b>NEW</b>	582,00 €
Grafite spazzolato PVD	SOI30118/2GUP	<b>NEW</b>	621,00 €
Caffè spazzolato	SOI30118/2SB	<b>NEW</b>	621,00 €
Argilla spazzolato PVD	SOI30118/2RTP	<b>NEW</b>	621,00 €
Cromo lucido	SOI30118/2CR	<b>NEW</b>	388,00 €



RCR2020  
41,00 €

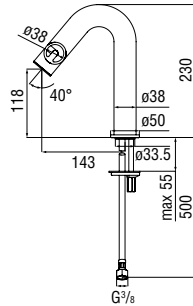

RAEK222/44  
61,00 € - 10 pz.

**Monocomando**

- Limitatore di energia con apertura in acqua fredda
- Aeratore anticalcare M 18,5 x 1, portata 5 l/min
- Senza scarico
- Flessibili inox ø 3/8"

Inox spazzolato	SOI30118/3IX	<b>NEW</b>	558,00 €
Grafite spazzolato PVD	SOI30118/3GUP	<b>NEW</b>	595,00 €
Caffè spazzolato	SOI30118/3SB	<b>NEW</b>	595,00 €
Argilla spazzolato PVD	SOI30118/3RTP	<b>NEW</b>	595,00 €
Cromo lucido	SOI30118/3CR	<b>NEW</b>	372,00 €



RCR2020  
41,00 €

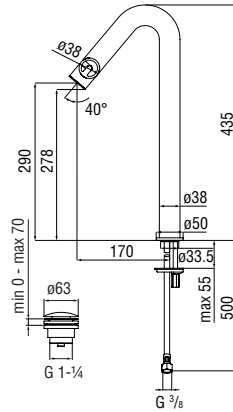

RAEK222/44  
61,00 € - 10 pz.

**Monocomando a bacinella**

- Limitatore di energia con apertura in acqua fredda
- Aeratore anticalcare M 18,5 x 1, portata 5 l/min
- Scarico 1 1/4" push
- Flessibili inox ø 3/8"

Inox spazzolato	SOI30128/2IX	<b>NEW</b>	722,00 €
Grafite spazzolato PVD	SOI30128/2GUP	<b>NEW</b>	770,00 €
Caffè spazzolato	SOI30128/2SB	<b>NEW</b>	770,00 €
Argilla spazzolato PVD	SOI30128/2RTP	<b>NEW</b>	770,00 €
Cromo lucido	SOI30128/2CR	<b>NEW</b>	481,00 €



RCR2020  
41,00 €

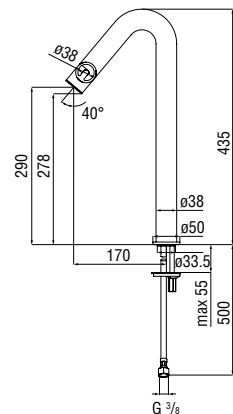

RAEK222/44  
61,00 € - 10 pz.

**Monocomando a bacinella**

- Limitatore di energia con apertura in acqua fredda
- Aeratore anticalcare M 18,5 x 1, portata 5 l/min
- Senza scarico
- Flessibili inox ø 3/8"

Inox spazzolato	SOI30128/3IX	<b>NEW</b>	698,00 €
Grafite spazzolato PVD	SOI30128/3GUP	<b>NEW</b>	744,00 €
Caffè spazzolato	SOI30128/3SB	<b>NEW</b>	744,00 €
Argilla spazzolato PVD	SOI30128/3RTP	<b>NEW</b>	744,00 €
Cromo lucido	SOI30128/3CR	<b>NEW</b>	465,00 €



RCR2020  
41,00 €

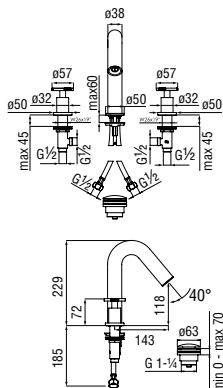

RAEK222/44  
61,00 € - 10 pz.

**Batteria 3 fori**

- Aeratore anticalcare M 18,5 x 1, portata 5 l/min
- Scarico 1 1/4" push

Inox spazzolato	SO130211/2IX	<b>NEW</b>	780,00 €
Grafite spazzolato PVD	SO130211/2GUP	<b>NEW</b>	832,00 €
Caffè spazzolato	SO130211/2SB	<b>NEW</b>	832,00 €
Argilla spazzolato PVD	SO130211/2RTP	<b>NEW</b>	832,00 €
Cromo lucido	SO130211/2CR	<b>NEW</b>	520,00 €



RVT200/5S  
18,00 €



RVT200/5D  
18,00 €

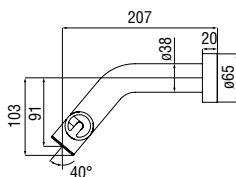

RAEK222/44  
61,00 € - 10 pz.

**Parte esterna monocomando a parete**

- Limitatore di energia con apertura in acqua fredda
- Aeratore anticalcare M 18,5 x 1, portata 5 l/min
- Lunghezza bocca 200 mm
- Senza scarico

Inox spazzolato	SO130198IX	<b>NEW</b>	495,00 €
Grafite spazzolato PVD	SO130198GUP	<b>NEW</b>	528,00 €
Caffè spazzolato	SO130198SB	<b>NEW</b>	528,00 €
Argilla spazzolato PVD	SO130198RTP	<b>NEW</b>	528,00 €
Cromo lucido	SO130198CR	<b>NEW</b>	330,00 €



RCR2020  
41,00 €



RAEK222/44  
61,00 € - 10 pz.

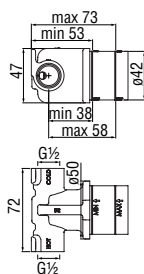

NR00212/25  
43,00 €

**Allbox, parte incasso necessaria**

- Ingresso acqua calda e acqua fredda ø 1/2"

-	WE00600	<b>MOD</b>	104,00 €
---	---------	------------	----------



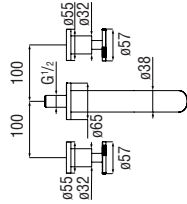
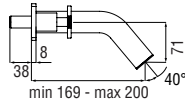

**Parte esterna batteria 3 fori a parete**

- Aeratore anticalcare M 18,5 x 1, portata 5 l/min
- Lunghezza bocca 200 mm
- Senza scarico

Inox spazzolato	SOI30298/EIX	<b>NEW</b>	558,00 €
Grafite spazzolato PVD	SOI30298/EGUP	<b>NEW</b>	595,00 €
Caffè spazzolato	SOI30298/ESB	<b>NEW</b>	595,00 €
Argilla spazzolato PVD	SOI30298/ERTP	<b>NEW</b>	595,00 €
Cromo lucido	SOI30298/ECR	<b>NEW</b>	372,00 €

RVT200/5S  
18,00 €

RVT200/5D  
18,00 €

RAEK222/44  
61,00 € - 10 pz.

NR00212/28  
41,00 €

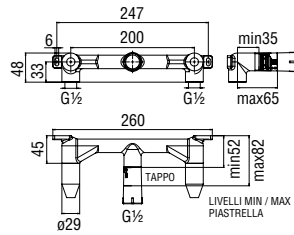

**Allbox, parte incasso necessaria**

- Ingresso acqua calda e acqua fredda ø 1/2"
- Uscita ø 1/2"

- WE00298 130,00 €

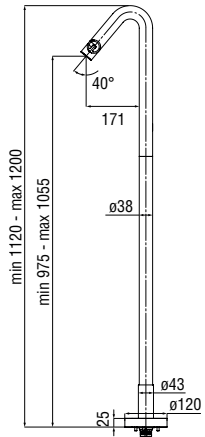

**Monocomando**

- Limitatore di energia con apertura in acqua fredda
- Aeratore anticalcare M 18,5 x 1, portata 5 l/min
- Senza scarico

Inox spazzolato	SOI30188/3IX	<b>NEW</b>	1.358,00 €
Grafite spazzolato PVD	SOI30188/3GUP	<b>NEW</b>	1.448,00 €
Caffè spazzolato	SOI30188/3SB	<b>NEW</b>	1.448,00 €
Argilla spazzolato PVD	SOI30188/3RTP	<b>NEW</b>	1.448,00 €
Cromo lucido	SOI30188/3CR	<b>NEW</b>	905,00 €

RCR2020  
41,00 €

RAEK222/44  
61,00 € - 10 pz.

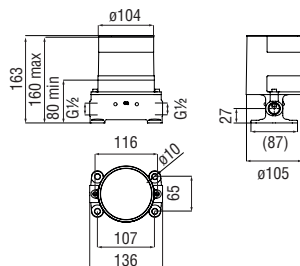

**Parte incasso necessaria**

- Ingresso acqua calda e acqua fredda ø 1/2"

- WE77250 **MOD** 291,00 €

## LAVABO A SOFFITTO

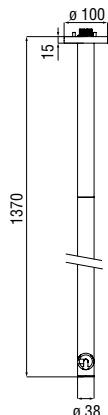

### Monocomando

- Limitatore di energia con apertura in acqua fredda
- Aeratore anticalcare M 18,5 x 1, portata 5 l/min
- Senza scarico

Nota: prolunga disponibile su richiesta

Inox spazzolato	SO130318/3EIX	NEW	1.293,00 €
Grafite spazzolato PVD	SO130318/3EGUP	NEW	1.379,00 €
Caffè spazzolato	SO130318/3ESB	NEW	1.379,00 €
Argilla spazzolato PVD	SO130318/3ERTP	NEW	1.379,00 €
Cromo lucido	SO130318/3ECR	NEW	862,00 €



RCR2020  
41,00 €



RAEK222/44  
61,00 € - 10 pz.

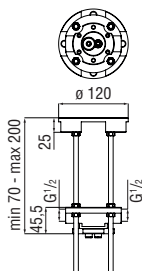

### Parte incasso necessaria

- Ingresso acqua calda e acqua fredda  $\varnothing$  1/2"

-	WE00318	NEW	320,00 €
---	---------	-----	----------

## BIDET

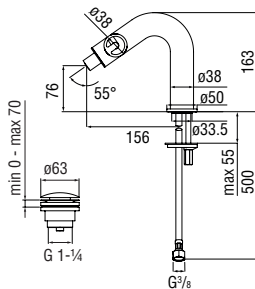

### Monocomando

- Limitatore di energia con apertura in acqua fredda
- Aeratore anticalcare M 18,5 x 1, portata 5 l/min
- Getto orientabile
- Scarico 1 1/4" push
- Flessibili inox  $\varnothing$  3/8"

Inox spazzolato	SO130119/2IX	NEW	582,00 €
Grafite spazzolato PVD	SO130119/2GUP	NEW	621,00 €
Caffè spazzolato	SO130119/2SB	NEW	621,00 €
Argilla spazzolato PVD	SO130119/2RTP	NEW	621,00 €
Cromo lucido	SO130119/2CR	NEW	388,00 €



RCR2020  
41,00 €



RAE222/44IX  
32,00 € - 10 pz.

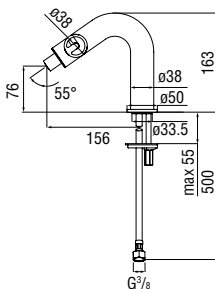

### Monocomando

- Limitatore di energia con apertura in acqua fredda
- Aeratore anticalcare M 18,5 x 1, portata 5 l/min
- Getto orientabile
- Senza scarico
- Flessibili inox  $\varnothing$  3/8"

Inox spazzolato	SO130119/3IX	NEW	558,00 €
Grafite spazzolato PVD	SO130119/3GUP	NEW	595,00 €
Caffè spazzolato	SO130119/3SB	NEW	595,00 €
Argilla spazzolato PVD	SO130119/3RTP	NEW	595,00 €
Cromo lucido	SO130119/3CR	NEW	372,00 €



RCR2020  
41,00 €



RAE222/44IX  
32,00 € - 10 pz.

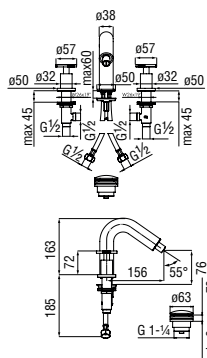

**Batteria 3 fori**

- Aeratore anticalcare M 18,5 x 1, portata 5 l/min
- Getto orientabile
- Scarico 1 1/4" push

Inox spazzolato	SO130215/2IX	<b>NEW</b>	780,00 €
Grafite spazzolato PVD	SO130215/2GUP	<b>NEW</b>	832,00 €
Caffè spazzolato	SO130215/2SB	<b>NEW</b>	832,00 €
Argilla spazzolato PVD	SO130215/2RTP	<b>NEW</b>	832,00 €
Cromo lucido	SO130215/2CR	<b>NEW</b>	520,00 €

- RVT200/5D 18,00 €
- RVT200/5S 18,00 €
- RAE222/44IX 32,00 € - 10 pz.

**BORDO VASCA**

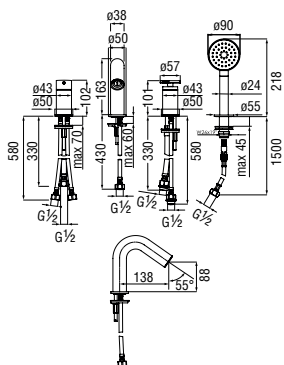

**Monocomando bordo vasca**

- Limitatore di portata con freno al 50%
- Aeratore anticalcare M 24 x 1
- Deviatore a 2 vie
- Doccetta monogetto estraibile

Inox spazzolato	WEBK110/9SOIX	<b>NEW</b>	1.455,00 €
Grafite spazzolato PVD	WEBK110/9SOGUP	<b>NEW</b>	1.552,00 €
Caffè spazzolato	WEBK110/9SOSB	<b>NEW</b>	1.552,00 €
Argilla spazzolato PVD	WEBK110/9SORTP	<b>NEW</b>	1.552,00 €
Cromo lucido	WEBK110/9SOCR	<b>NEW</b>	970,00 €

- CARTRIDGE WARRANTY
- RCR350 39,00 €
- RCR201/35FSC 39,00 €
- RAEK222/22 45,00 € - 10 pz.

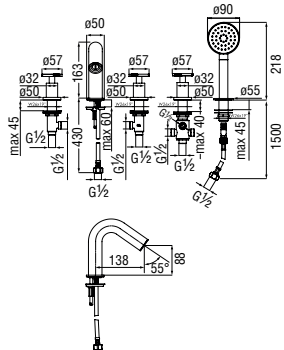

**Batteria 5 fori bordo vasca**

- Aeratore anticalcare M 24 x 1
- Deviatore a 2 vie
- Doccetta monogetto estraibile

Inox spazzolato	WEBK204/SOIX	<b>NEW</b>	1.773,00 €
Grafite spazzolato PVD	WEBK204/SOGUP	<b>NEW</b>	1.891,00 €
Caffè spazzolato	WEBK204/SOSB	<b>NEW</b>	1.891,00 €
Argilla spazzolato PVD	WEBK204/SORTP	<b>NEW</b>	1.891,00 €
Cromo lucido	WEBK204/SOCR	<b>NEW</b>	1.182,00 €

- RVT200/5S 18,00 €
- RVT200/5D 18,00 €
- RAEK222/22 45,00 € - 10 pz.

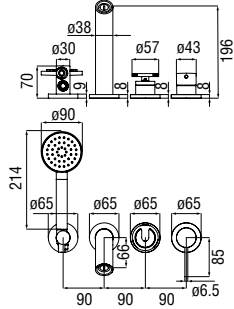

**Parte esterna monocomando incasso a 2 vie**

- Limitatore di portata con freno al 50%
- Deviatore a 2 vie
- Aeratore anticalcare M 24 x 1
- Doccetta monogetto e flessibile 150 cm

Inox spazzolato	WEBK110/91SOIX	NEW	915,00 €
Grafite spazzolato PVD	WEBK110/91SOGUP	NEW	976,00 €
Caffè spazzolato	WEBK110/91SOSB	NEW	976,00 €
Argilla spazzolato PVD	WEBK110/91SORTP	NEW	976,00 €
Cromo lucido	WEBK110/91SOCR	NEW	610,00 €



RAEK222/22  
45,00 € - 10 pz.



NR00212/22IX  
142,00 €

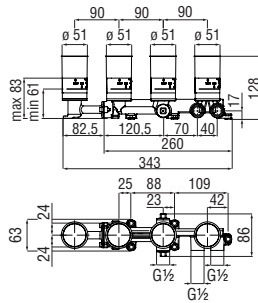

**Parte incasso necessaria**

- Ingresso e uscita acqua ø 1/2"

-	WE81201/T	NEW	390,00 €
---	-----------	-----	----------



CARTRIDGE  
WARRANTY



RCR350  
39,00 €



RCR201/35FSC  
39,00 €

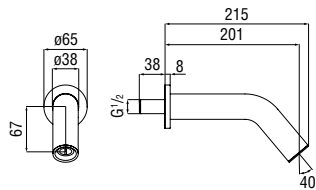

**Bocca a parete**

- Aeratore anticalcare M 24 x 1
- Lunghezza 200 mm

Inox spazzolato	AV00158/54DIX	NEW	291,00 €
Grafite spazzolato PVD	AV00158/54DGUP	NEW	310,00 €
Caffè spazzolato	AV00158/54DSB	NEW	310,00 €
Argilla spazzolato PVD	AV00158/54DRTP	NEW	310,00 €
Cromo lucido	AV00158/54DCR	NEW	194,00 €

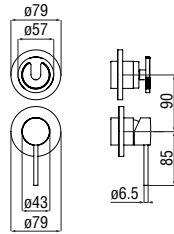

RAEK222/22  
45,00 € - 10 pz.

**Parte esterna monocomando incasso a 2-3 vie**

- Limitatore di portata con freno al 50%
- Tenuta o-ring invisibile, fissaggio a parete impermeabile

Inox spazzolato	WE81102/ISOIX	<b>NEW</b>	615,00 €
Grafite spazzolato PVD	WE81102/ISOGUP	<b>NEW</b>	656,00 €
Caffè spazzolato	WE81102/ISOSB	<b>NEW</b>	656,00 €
Argilla spazzolato PVD	WE81102/ISORTP	<b>NEW</b>	656,00 €
Cromo lucido	WE81102/ISO CR	<b>NEW</b>	410,00 €

**Techbox 2 vie, parte incasso necessaria**

- Deviatore a 2 vie ceramico
- Ingresso e uscita acqua  $\varnothing 1/2''$
- Adatta anche a montaggio su cartongesso

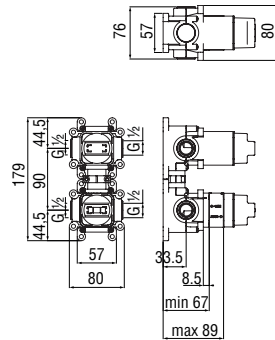

- WE81102 160,00 €



CARTRIDGE  
WARRANTY



RCR350  
39,00 €



RCR201/35FSC  
39,00 €



NR00212/30  
85,00 €

**Parte esterna monocomando incasso a 2-3 vie**

- Limitatore di portata con freno al 50%
- Tenuta o-ring invisibile, fissaggio a parete impermeabile

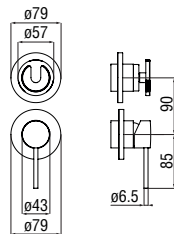

Inox spazzolato	WE81102/ISOIX	<b>NEW</b>	615,00 €
Grafite spazzolato PVD	WE81102/ISOGUP	<b>NEW</b>	656,00 €
Caffè spazzolato	WE81102/ISOSB	<b>NEW</b>	656,00 €
Argilla spazzolato PVD	WE81102/ISORTP	<b>NEW</b>	656,00 €
Cromo lucido	WE81102/ISO CR	<b>NEW</b>	410,00 €

**Techbox 3 vie, parte incasso necessaria**

- Deviatore a 3 vie ceramico
- Ingresso e uscita acqua  $\varnothing 1/2''$
- Adatta anche a montaggio su cartongesso

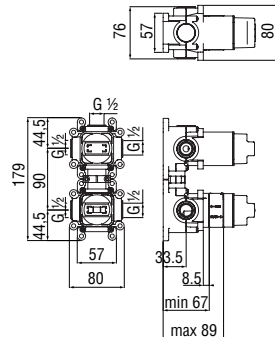

- WE81103 184,00 €



CARTRIDGE  
WARRANTY



RCR350  
39,00 €



RCR201/35C  
39,00 €

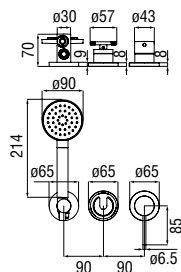

NR00212/32  
85,00 €

**Parte esterna monocomando incasso a 2 vie**

- Limitatore di portata con freno al 50%
- Doccetta monogetto e flessibile 150 cm
- Deviatore a 2 vie
- Abbinamento libero per la seconda via

Inox spazzolato	WESK100/ISOIX	NEW	719,00 €
Grafite spazzolato PVD	WESK100/ISOGUP	NEW	766,00 €
Caffè spazzolato	WESK100/ISOSB	NEW	766,00 €
Argilla spazzolato PVD	WESK100/ISORTP	NEW	766,00 €
Cromo lucido	WESK100/ISO CR	NEW	479,00 €



NR00212/22IX  
142,00 €

**Parte incasso necessaria**

- Ingresso e uscita acqua  $\varnothing 1/2"$

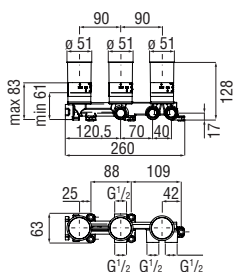

-	WE81200/T	NEW	334,00 €
---	-----------	-----	----------



CARTRIDGE  
WARRANTY



RCR350  
39,00 €



RCR201/35FSC  
39,00 €

**Coppia di rubinetti d'arresto a incasso**

- Ingresso a 2 vie
- Uscite  $\varnothing 1/2"$

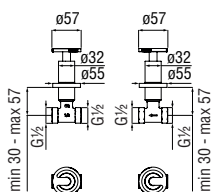

Inox spazzolato	SOK130208IX	NEW	398,00 €
Grafite spazzolato PVD	SOK130208GUP	NEW	424,00 €
Caffè spazzolato	SOK130208SB	NEW	424,00 €
Argilla spazzolato PVD	SOK130208RTP	NEW	424,00 €
Cromo lucido	SOK130208CR	NEW	265,00 €



RVT200/5D  
18,00 €



RVT200/5S  
18,00 €



NR00212/26  
38,00 €

**Deviatore 2 vie**

- Ingresso a 2 vie
- Uscite  $\varnothing 1/2"$

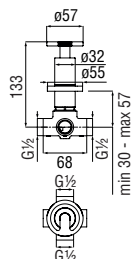

Inox spazzolato	SO130160IX	NEW	384,00 €
Grafite spazzolato PVD	SO130160GUP	NEW	410,00 €
Caffè spazzolato	SO130160SB	NEW	410,00 €
Argilla spazzolato PVD	SO130160RTP	NEW	410,00 €
Cromo lucido	SO130160CR	NEW	256,00 €



NR00212/27  
24,00 €



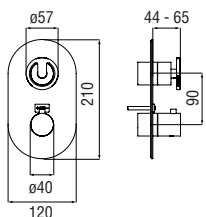

**Parte esterna termostatico a 1-2 vie**

- Blocco di sicurezza 38° C
- Montaggio verticale o orizzontale

Inox spazzolato	SOI30101IX	NEW	690,00 €
Grafite spazzolato PVD	SOI30101GUP	NEW	736,00 €
Caffè spazzolato	SOI30101SB	NEW	736,00 €
Argilla spazzolato PVD	SOI30101RTP	NEW	736,00 €
Cromo lucido	SOI30101CR	NEW	460,00 €

  
NR00008  
34,00 €

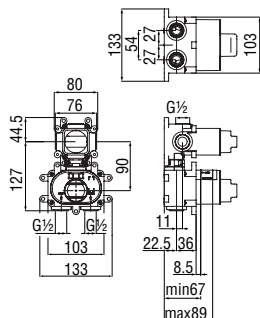

**Wellbox 1 via, parte incasso necessaria**

- Ingresso e uscita acqua ø 1/2"
- Rubinetti di chiusura
- Valvole antiritorno
- Adatta anche a montaggio su cartongesso
- Filtri di ricambio cartuccia inclusi nella confezione

- WE00101 167,00 €

  
RCR201/5  
58,00 €

  
RVT200/5D  
18,00 €

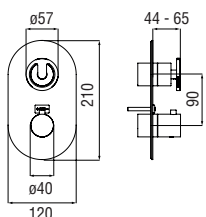

**Parte esterna termostatico a 1-2 vie**

- Blocco di sicurezza 38° C
- Montaggio verticale o orizzontale

Inox spazzolato	SOI30101IX	NEW	690,00 €
Grafite spazzolato PVD	SOI30101GUP	NEW	736,00 €
Caffè spazzolato	SOI30101SB	NEW	736,00 €
Argilla spazzolato PVD	SOI30101RTP	NEW	736,00 €
Cromo lucido	SOI30101CR	NEW	460,00 €

  
NR00008  
34,00 €

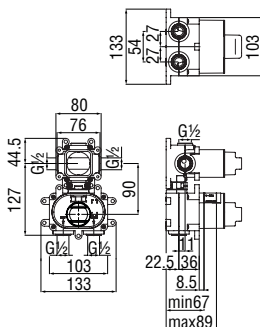

**Wellbox 2 vie, parte incasso necessaria**

- Ingresso e uscita acqua ø 1/2"
- Rubinetti di chiusura
- Valvole antiritorno
- Adatta anche a montaggio su cartongesso
- Filtri di ricambio cartuccia inclusi nella confezione

- WE00102 215,00 €

  
RCR201/5  
58,00 €

  
RCR201/28  
39,00 €

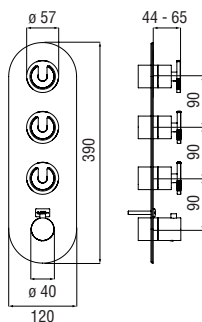

**Parte esterna termostatico a 3-4 vie**

- Blocco di sicurezza 38° C
- Montaggio verticale o orizzontale

Inox spazzolato	SO130103IX	NEW	1.428,00 €
Grafite spazzolato PVD	SO130103GUP	NEW	1.523,00 €
Caffè spazzolato	SO130103SB	NEW	1.523,00 €
Argilla spazzolato PVD	SO130103RTP	NEW	1.523,00 €
Cromo lucido	SO130103CR	NEW	952,00 €

  
NR00008  
34,00 €

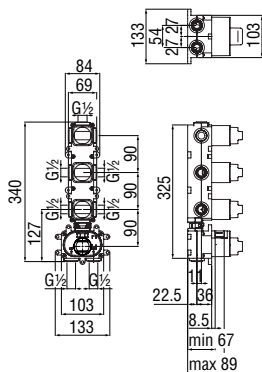

**Wellbox 3 vie, parte incasso necessaria**

- Ingresso e uscita acqua ø 1/2"
- Rubinetti di chiusura
- Valvoline antiritorno
- Adatta anche a montaggio su cartongesso
- Filtri di ricambio cartuccia inclusi nella confezione

- WE00103 318,00 €

  
RCR201/5  
58,00 €

  
RVT200/5D  
18,00 €

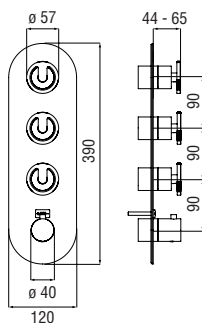

**Parte esterna termostatico a 3-4 vie**

- Blocco di sicurezza 38° C
- Montaggio verticale o orizzontale

Inox spazzolato	SO130103IX	NEW	1.428,00 €
Grafite spazzolato PVD	SO130103GUP	NEW	1.523,00 €
Caffè spazzolato	SO130103SB	NEW	1.523,00 €
Argilla spazzolato PVD	SO130103RTP	NEW	1.523,00 €
Cromo lucido	SO130103CR	NEW	952,00 €

  
NR00008  
34,00 €

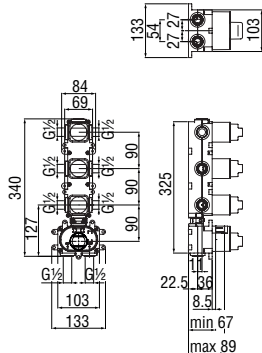

**Wellbox 4 vie, parte incasso necessaria**

- Ingresso e uscita acqua ø 1/2"
- Rubinetti di chiusura
- Valvoline antiritorno
- Adatta anche a montaggio su cartongesso
- Filtri di ricambio cartuccia inclusi nella confezione

- WE00104 360,00 €

  
RCR201/5  
58,00 €

  
RCR201/28  
39,00 €

  
RVT200/5D  
18,00 €

**Braccio a parete**

· Lunghezza 350 mm



Inox spazzolato	AD138/44IX		135,00 €
Grafite spazzolato PVD	AD138/44GUP		146,00 €
Caffè spazzolato	AD138/44SB	<b>NEW</b>	146,00 €
Argilla spazzolato PVD	AD138/44RTP		146,00 €
Cromo lucido	AD138/44CR		90,00 €

**Braccio a soffitto**

· Lunghezza 300 mm



Inox spazzolato	AD138/64IX		223,00 €
Grafite spazzolato PVD	AD138/64GUP		238,00 €
Caffè spazzolato	AD138/64SB	<b>NEW</b>	238,00 €
Argilla spazzolato PVD	AD138/64RTP		238,00 €
Cromo lucido	AD138/64CR		149,00 €

## SOFFIONI DOCCIA

**Soffione a snodo (Inox)**· Dimensione  $\varnothing$  290 mm

· Getto pioggia



Inox spazzolato	AD139/138IX	<b>NEW</b>	1.950,00 €
Grafite spazzolato PVD	AD139/138GUP	<b>NEW</b>	2.080,00 €
Caffè spazzolato	AD139/138SB	<b>NEW</b>	2.080,00 €
Argilla spazzolato PVD	AD139/138RTP	<b>NEW</b>	2.080,00 €
Cromo lucido	AD139/138CR	<b>NEW</b>	1.300,00 €

**Soffione a parete (Ottone)**

· Getto pioggia

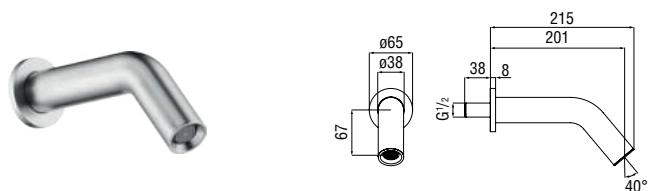

Inox spazzolato	AD139/137IX	<b>NEW</b>	321,00 €
Grafite spazzolato PVD	AD139/137GUP	<b>NEW</b>	342,00 €
Caffè spazzolato	AD139/137SB	<b>NEW</b>	342,00 €
Argilla spazzolato PVD	AD139/137RTP	<b>NEW</b>	342,00 €
Cromo lucido	AD139/137CR	<b>NEW</b>	214,00 €

**Bodyjet esterno**

· Getto pioggia orientabile

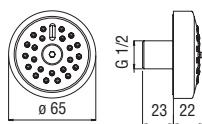

Inox spazzolato	WE00139/81IX		236,00 €
Grafite spazzolato PVD	WE00139/81GUP		251,00 €
Caffè spazzolato	WE00139/81SB	<b>NEW</b>	251,00 €
Argilla spazzolato PVD	WE00139/81RTP		251,00 €
Cromo lucido	WE00139/81CR		158,00 €

**SET DOCCIA**

**Set doccia con presa acqua ø 1/2"**

· Supporto doccetta fisso rivestito in Teflon  
· Doccetta monogetto e flessibile 150 cm

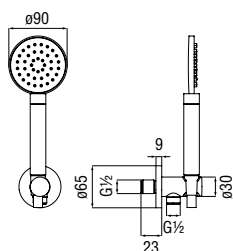

Inox spazzolato	AD146/54IX	<b>NEW</b>	405,00 €
Grafite spazzolato PVD	AD146/54GUP	<b>NEW</b>	432,00 €
Caffè spazzolato	AD146/54SB	<b>NEW</b>	432,00 €
Argilla spazzolato PVD	AD146/54RTP	<b>NEW</b>	432,00 €
Cromo lucido	AD146/54CR	<b>NEW</b>	270,00 €



RUBINETTERIA NOBILI

# VELIS

Centro Stile Nobili

Puro minimalismo, pura tecnologia, pura libertà. Velis elimina il superfluo e torna all'essenziale, attraverso una linea moderna e senza tempo. La cartuccia a immersione totale Nobili Widd® nella sua versione più recente con miscelazione assiale permette un inedito e straordinario equilibrio tra stile e avanguardia: elimina il blocco cartuccia laterale e dà vita ad una linea estremamente pulita e filante.



Cromo lucido



Inox spazzolato



Grafite spazzolato PVD



Miele spazzolato PVD



Caffè spazzolato



Tramonto lucido PVD



Argilla spazzolato PVD

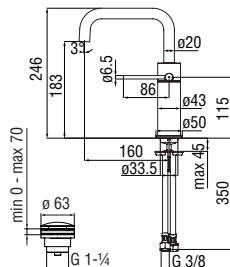

**Monocomando**

- Limitatore di energia con apertura in acqua fredda
- Aeratore anticalcare M 18 x 1, portata 5 l/min
- Bocca girevole
- Scarico 1 1/4" push, flessibili inox ø 3/8"

Cromo lucido	VE125118/2CR	352,00 €
Inox spazzolato	VE125118/2IX	528,00 €
Grafite spazzolato PVD	VE125118/2GUP	563,00 €
Miele spazzolato PVD	VE125118/2CGP	<b>NEW</b> 563,00 €
Caffè spazzolato	VE125118/2SB	<b>NEW</b> 563,00 €
Tramonto lucido PVD	VE125118/2RCP	563,00 €
Argilla spazzolato PVD	VE125118/2RTP	563,00 €

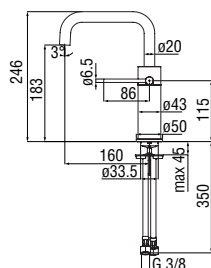
RCR2020  
41,00 €RAEK222/42  
45,00 € - 10 pz.**Monocomando**

- Limitatore di energia con apertura in acqua fredda
- Aeratore anticalcare M 18 x 1, portata 5 l/min
- Bocca girevole
- Senza scarico, flessibili inox ø 3/8"

Cromo lucido	VE125118/3CR	335,00 €
Inox spazzolato	VE125118/3IX	503,00 €
Grafite spazzolato PVD	VE125118/3GUP	536,00 €
Miele spazzolato PVD	VE125118/3CGP	<b>NEW</b> 536,00 €
Caffè spazzolato	VE125118/3SB	<b>NEW</b> 536,00 €
Tramonto lucido PVD	VE125118/3RCP	536,00 €
Argilla spazzolato PVD	VE125118/3RTP	536,00 €

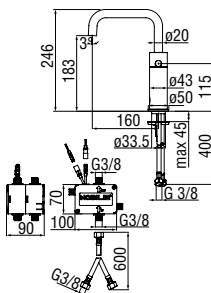
RCR2020  
41,00 €RAEK222/42  
45,00 € - 10 pz.**Comando infrarossi**

- Aeratore anticalcare M 18 x 1, portata 5 l/min
- Bocca girevole
- Alimentazione a batteria
- Senza scarico, flessibili inox ø 3/8"

Cromo lucido	IRVE125118/3CR	463,00 €
Inox spazzolato	IRVE125118/3IX	695,00 €
Grafite spazzolato PVD	IRVE125118/3GUP	741,00 €
Miele spazzolato PVD	IRVE125118/3CGP	<b>NEW</b> 741,00 €
Caffè spazzolato	IRVE125118/3SB	<b>NEW</b> 741,00 €
Tramonto lucido PVD	IRVE125118/3RCP	741,00 €
Argilla spazzolato PVD	IRVE125118/3RTP	741,00 €

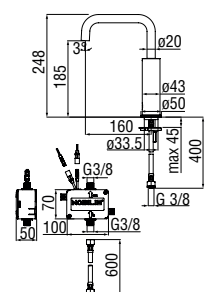
RAEK222/42  
45,00 € - 10 pz.**Comando infrarossi monoacqua**

- Aeratore anticalcare M 18 x 1, portata 5 l/min
- Alimentazione a batteria
- Senza scarico, flessibili inox ø 3/8"

Cromo lucido	IRVE125236CR	419,00 €
Inox spazzolato	IRVE125236IX	629,00 €
Grafite spazzolato PVD	IRVE125236GUP	670,00 €
Miele spazzolato PVD	IRVE125236CGP	<b>NEW</b> 670,00 €
Caffè spazzolato	IRVE125236SB	<b>NEW</b> 670,00 €
Tramonto lucido PVD	IRVE125236RCP	670,00 €
Argilla spazzolato PVD	IRVE125236RTP	670,00 €

RAEK222/42  
45,00 € - 10 pz.

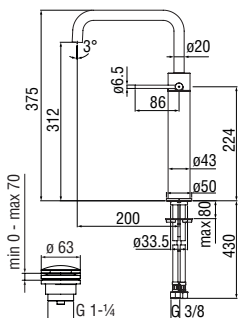
**Monocomando a bacinella**

- Limitatore di energia con apertura in acqua fredda
- Aeratore anticalcare M 18 x 1, portata 5 l/min
- Bocca girevole
- Scarico 1 1/4" push, flessibili inox ø 3/8"

Cromo lucido	VE125158/2CR	437,00 €
Inox spazzolato	VE125158/2IX	655,00 €
Grafite spazzolato PVD	VE125158/2GUP	698,00 €
Miele spazzolato PVD	VE125158/2CGP	<b>NEW</b> 698,00 €
Caffè spazzolato	VE125158/2SB	<b>NEW</b> 698,00 €
Tramonto lucido PVD	VE125158/2RCP	698,00 €
Argilla spazzolato PVD	VE125158/2RTP	698,00 €



RCR2020  
41,00 €

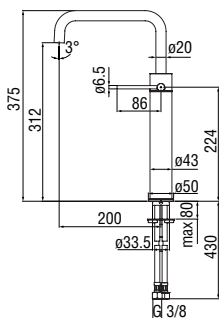

RAEK222/42  
45,00 € - 10 pz.

**Monocomando a bacinella**

- Limitatore di energia con apertura in acqua fredda
- Aeratore anticalcare M 18 x 1, portata 5 l/min
- Bocca girevole
- Senza scarico, flessibili inox ø 3/8"

Cromo lucido	VE125158/3CR	420,00 €
Inox spazzolato	VE125158/3IX	631,00 €
Grafite spazzolato PVD	VE125158/3GUP	673,00 €
Miele spazzolato PVD	VE125158/3CGP	<b>NEW</b> 673,00 €
Caffè spazzolato	VE125158/3SB	<b>NEW</b> 673,00 €
Tramonto lucido PVD	VE125158/3RCP	673,00 €
Argilla spazzolato PVD	VE125158/3RTP	673,00 €



RCR2020  
41,00 €

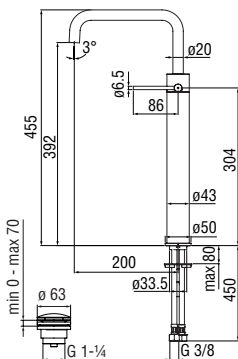

RAEK222/42  
45,00 € - 10 pz.

**Monocomando a bacinella**

- Limitatore di energia con apertura in acqua fredda
- Aeratore anticalcare M 18 x 1, portata 5 l/min
- Bocca girevole
- Scarico 1 1/4" push, flessibili inox ø 3/8"

Cromo lucido	VE125128/2CR	495,00 €
Inox spazzolato	VE125128/2IX	743,00 €
Grafite spazzolato PVD	VE125128/2GUP	793,00 €
Miele spazzolato PVD	VE125128/2CGP	<b>NEW</b> 793,00 €
Caffè spazzolato	VE125128/2SB	<b>NEW</b> 793,00 €
Tramonto lucido PVD	VE125128/2RCP	793,00 €
Argilla spazzolato PVD	VE125128/2RTP	793,00 €



RCR2020  
41,00 €

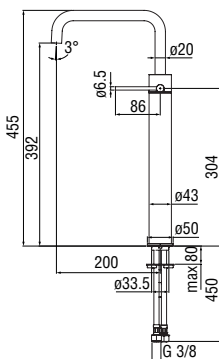

RAEK222/42  
45,00 € - 10 pz.

**Monocomando a bacinella**

- Limitatore di energia con apertura in acqua fredda
- Aeratore anticalcare M 18 x 1, portata 5 l/min
- Bocca girevole
- Senza scarico, flessibili inox ø 3/8"

Cromo lucido	VE125128/3CR	479,00 €
Inox spazzolato	VE125128/3IX	718,00 €
Grafite spazzolato PVD	VE125128/3GUP	765,00 €
Miele spazzolato PVD	VE125128/3CGP	<b>NEW</b> 765,00 €
Caffè spazzolato	VE125128/3SB	<b>NEW</b> 765,00 €
Tramonto lucido PVD	VE125128/3RCP	765,00 €
Argilla spazzolato PVD	VE125128/3RTP	765,00 €



RCR2020  
41,00 €

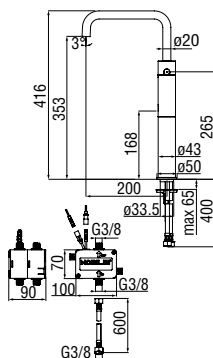

RAEK222/42  
45,00 € - 10 pz.

**Comando infrarossi a bacinella**

- Aeratore anticalcare M 18 x 1, portata 5 l/min
- Bocca girevole
- Alimentazione a batteria
- Senza scarico, flessibili inox  $\varnothing$  3/8"

Cromo lucido	IRVE125128/3CR	529,00 €
Inox spazzolato	IRVE125128/3IX	794,00 €
Grafite spazzolato PVD	IRVE125128/3GUP	846,00 €
Miele spazzolato PVD	IRVE125128/3CGP	<b>NEW</b> 846,00 €
Caffè spazzolato	IRVE125128/3SB	<b>NEW</b> 846,00 €
Tramonto lucido PVD	IRVE125128/3RCP	846,00 €
Argilla spazzolato PVD	IRVE125128/3RTP	846,00 €

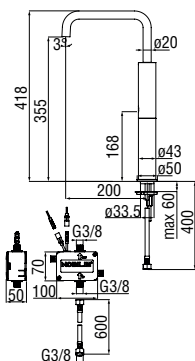

RAEK222/42  
45,00 € - 10 pz.

**Comando infrarossi monoacqua a bacinella**

- Aeratore anticalcare M 18 x 1, portata 5 l/min
- Alimentazione a batteria
- Senza scarico, flessibili inox  $\varnothing$  3/8"

Cromo lucido	IRVE125238CR	463,00 €
Inox spazzolato	IRVE125238IX	695,00 €
Grafite spazzolato PVD	IRVE125238GUP	741,00 €
Miele spazzolato PVD	IRVE125238CGP	<b>NEW</b> 741,00 €
Caffè spazzolato	IRVE125238SB	<b>NEW</b> 741,00 €
Tramonto lucido PVD	IRVE125238RCP	741,00 €
Argilla spazzolato PVD	IRVE125238RTP	741,00 €

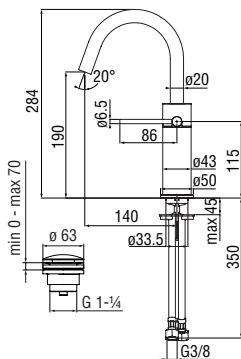

RAEK222/42  
45,00 € - 10 pz.

**Monocomando**

- Limitatore di energia con apertura in acqua fredda
- Aeratore anticalcare M 18 x 1, portata 5 l/min
- Bocca girevole
- Scarico 1 1/4" push, flessibili inox  $\varnothing$  3/8"

Cromo lucido	VE125138/2CR	352,00 €
Inox spazzolato	VE125138/2IX	528,00 €
Grafite spazzolato PVD	VE125138/2GUP	563,00 €
Miele spazzolato PVD	VE125138/2CGP	<b>NEW</b> 563,00 €
Caffè spazzolato	VE125138/2SB	<b>NEW</b> 563,00 €
Tramonto lucido PVD	VE125138/2RCP	563,00 €
Argilla spazzolato PVD	VE125138/2RTP	563,00 €



RCR2020  
41,00 €

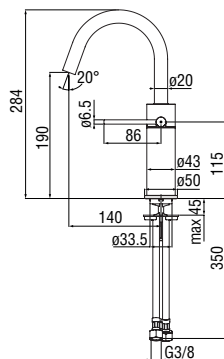

RAEK222/42  
45,00 € - 10 pz.

**Monocomando**

- Limitatore di energia con apertura in acqua fredda
- Aeratore anticalcare M 18 x 1, portata 5 l/min
- Bocca girevole
- Senza scarico, flessibili inox  $\varnothing$  3/8"

Cromo lucido	VE125138/3CR	335,00 €
Inox spazzolato	VE125138/3IX	503,00 €
Grafite spazzolato PVD	VE125138/3GUP	536,00 €
Miele spazzolato PVD	VE125138/3CGP	<b>NEW</b> 536,00 €
Caffè spazzolato	VE125138/3SB	<b>NEW</b> 536,00 €
Tramonto lucido PVD	VE125138/3RCP	536,00 €
Argilla spazzolato PVD	VE125138/3RTP	536,00 €



RCR2020  
41,00 €

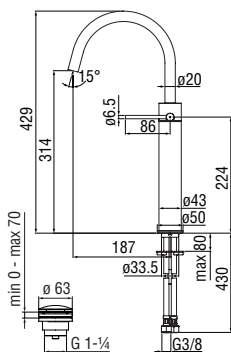

RAEK222/42  
45,00 € - 10 pz.

**Monocomando a bacinella**

- Limitatore di energia con apertura in acqua fredda
- Aeratore anticalcare M 18 x 1, portata 5 l/min
- Bocca girevole
- Scarico 1 1/4" push, flessibili inox ø 3/8"

Cromo lucido	VE125168/2CR	437,00 €
Inox spazzolato	VE125168/2IX	655,00 €
Grafite spazzolato PVD	VE125168/2GUP	698,00 €
Miele spazzolato PVD	VE125168/2CGP	<b>NEW</b> 698,00 €
Caffè spazzolato	VE125168/2SB	<b>NEW</b> 698,00 €
Tramonto lucido PVD	VE125168/2RCP	698,00 €
Argilla spazzolato PVD	VE125168/2RTP	698,00 €



RCR2020  
41,00 €

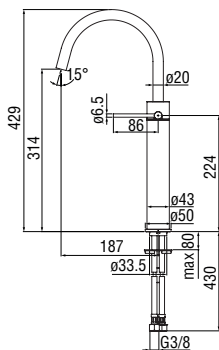

RAEK222/42  
45,00 € - 10 pz.

**Monocomando a bacinella**

- Limitatore di energia con apertura in acqua fredda
- Aeratore anticalcare M 18 x 1, portata 5 l/min
- Bocca girevole
- Senza scarico, flessibili inox ø 3/8"

Cromo lucido	VE125168/3CR	420,00 €
Inox spazzolato	VE125168/3IX	631,00 €
Grafite spazzolato PVD	VE125168/3GUP	673,00 €
Miele spazzolato PVD	VE125168/3CGP	<b>NEW</b> 673,00 €
Caffè spazzolato	VE125168/3SB	<b>NEW</b> 673,00 €
Tramonto lucido PVD	VE125168/3RCP	673,00 €
Argilla spazzolato PVD	VE125168/3RTP	673,00 €



RCR2020  
41,00 €

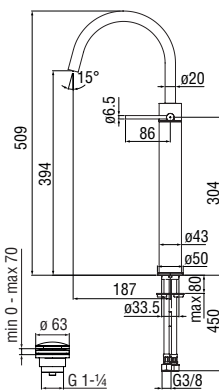

RAEK222/42  
45,00 € - 10 pz.

**Monocomando a bacinella**

- Limitatore di energia con apertura in acqua fredda
- Aeratore anticalcare M 18 x 1, portata 5 l/min
- Bocca girevole
- Scarico 1 1/4" push, flessibili inox ø 3/8"

Cromo lucido	VE125148/2CR	495,00 €
Inox spazzolato	VE125148/2IX	743,00 €
Grafite spazzolato PVD	VE125148/2GUP	793,00 €
Miele spazzolato PVD	VE125148/2CGP	<b>NEW</b> 793,00 €
Caffè spazzolato	VE125148/2SB	<b>NEW</b> 793,00 €
Tramonto lucido PVD	VE125148/2RCP	793,00 €
Argilla spazzolato PVD	VE125148/2RTP	793,00 €



RCR2020  
41,00 €

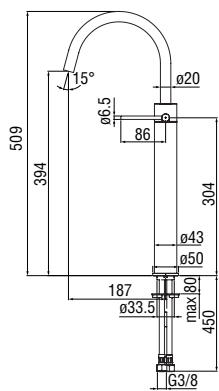

RAEK222/42  
45,00 € - 10 pz.

**Monocomando a bacinella**

- Limitatore di energia con apertura in acqua fredda
- Aeratore anticalcare M 18 x 1, portata 5 l/min
- Bocca girevole
- Senza scarico, flessibili inox ø 3/8"

Cromo lucido	VE125148/3CR	479,00 €
Inox spazzolato	VE125148/3IX	718,00 €
Grafite spazzolato PVD	VE125148/3GUP	765,00 €
Miele spazzolato PVD	VE125148/3CGP	<b>NEW</b> 765,00 €
Caffè spazzolato	VE125148/3SB	<b>NEW</b> 765,00 €
Tramonto lucido PVD	VE125148/3RCP	765,00 €
Argilla spazzolato PVD	VE125148/3RTP	765,00 €



RCR2020  
41,00 €



RAEK222/42  
45,00 € - 10 pz.

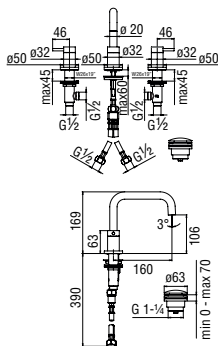

**Batteria 3 fori**

- Aeratore anticalcare M 18 x 1, portata 5 l/min
- Scarico 1 1/4" push

Cromo lucido	VE125211/2CR	472,00 €
Inox spazzolato	VE125211/2IX	709,00 €
Grafite spazzolato PVD	VE125211/2GUP	787,00 €
Miele spazzolato PVD	VE125211/2CGP	<b>NEW</b> 787,00 €
Caffè spazzolato	VE125211/2SB	<b>NEW</b> 787,00 €
Tramonto lucido PVD	VE125211/2RCP	787,00 €
Argilla spazzolato PVD	VE125211/2RTP	787,00 €

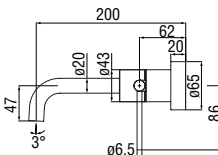

**Parte esterna monocomando a parete**

- Limitatore di energia con apertura in acqua fredda
- Aeratore anticalcare M 18 x 1, portata 5 l/min
- Lunghezza bocca 200 mm
- Senza scarico

Cromo lucido	VE125198/1CR	260,00 €
Inox spazzolato	VE125198/1IX	391,00 €
Grafite spazzolato PVD	VE125198/1GUP	416,00 €
Miele spazzolato PVD	VE125198/1CGP	<b>NEW</b> 416,00 €
Caffè spazzolato	VE125198/1SB	<b>NEW</b> 416,00 €
Tramonto lucido PVD	VE125198/1RCP	416,00 €
Argilla spazzolato PVD	VE125198/1RTP	416,00 €

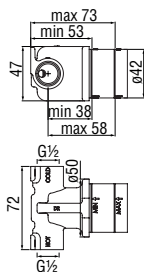

**Allbox, parte incasso necessaria**

- Ingresso acqua calda e acqua fredda ø 1/2"

-	WE00600	<b>MOD</b>	104,00 €
---	---------	------------	----------

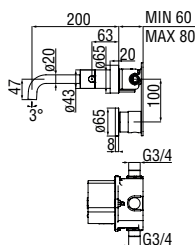

**Comando infrarossi a parete**

- Aeratore anticalcare M 18 x 1, portata 5 l/min
- Lunghezza bocca 200 mm
- Alimentazione a batteria
- Senza scarico

Cromo lucido	IRVE125198/1CR	938,00 €
Inox spazzolato	IRVE125198/1IX	1.406,00 €
Grafite spazzolato PVD	IRVE125198/1GUP	1.499,00 €
Miele spazzolato PVD	IRVE125198/1CGP	<b>NEW</b> 1.499,00 €
Caffè spazzolato	IRVE125198/1SB	<b>NEW</b> 1.499,00 €
Tramonto lucido PVD	IRVE125198/1RCP	1.499,00 €
Argilla spazzolato PVD	IRVE125198/1RTP	1.499,00 €

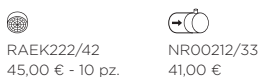

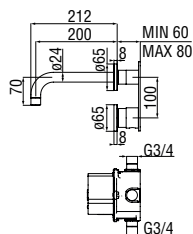

### Comando infrarossi monoacqua a parete

- Aeratore anticalcare M 22 x 1
- Lunghezza 200 mm
- Alimentazione a batteria
- Senza scarico

Cromo lucido	IRAV00158/TCR	860,00 €
Inox spazzolato	IRAV00158/TIX	1.290,00 €
Grafite spazzolato PVD	IRAV00158/TGUP	1.376,00 €
Miele spazzolato PVD	IRAV00158/TCGP	<b>NEW</b> 1.376,00 €
Caffè spazzolato	IRAV00158/TSB	<b>NEW</b> 1.376,00 €
Tramonto lucido PVD	IRAV00158/TRCP	1.376,00 €
Argilla spazzolato PVD	IRAV00158/TRTP	1.376,00 €



RAEK220/36CR  
53,00 € - 10 pz.

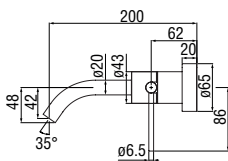

### Parte esterna monocomando a parete

- Limitatore di energia con apertura in acqua fredda
- Aeratore anticalcare M 18 x 1, portata 5 l/min
- Lunghezza bocca 200 mm
- Senza scarico

Cromo lucido	VE125199/ICR	258,00 €
Inox spazzolato	VE125199/IIX	387,00 €
Grafite spazzolato PVD	VE125199/IGUP	413,00 €
Miele spazzolato PVD	VE125199/ICGP	<b>NEW</b> 413,00 €
Caffè spazzolato	VE125199/ISB	<b>NEW</b> 413,00 €
Tramonto lucido PVD	VE125199/IRCP	413,00 €
Argilla spazzolato PVD	VE125199/IRTP	413,00 €



RCR2020  
41,00 €



RAEK222/42  
45,00 € - 10 pz.



NR00212/25  
43,00 €

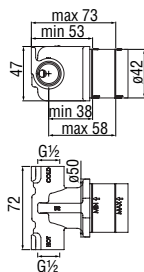

### Allbox, parte incasso necessaria

- Ingresso acqua calda e acqua fredda ø 1/2"

- WE00600 **MOD** 104,00 €

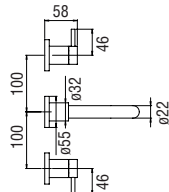
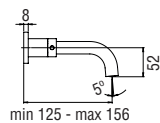

**Parte esterna batteria 3 fori a parete**

- Aeratore anticalcare M 18,5 x 1, portata 5 l/min
- Lunghezza bocca min 125 - max 156 mm
- Senza scarico

Cromo lucido	VE125298/ECR	290,00 €
Inox spazzolato	VE125298/EIX	435,00 €
Grafite spazzolato PVD	VE125298/EGUP	551,00 €
Miele spazzolato PVD	VE125298/ECGP	<b>NEW</b> 551,00 €
Caffè spazzolato	VE125298/ESB	<b>NEW</b> 551,00 €
Tramonto lucido PVD	VE125298/ERCP	551,00 €
Argilla spazzolato PVD	VE125298/ERTP	551,00 €

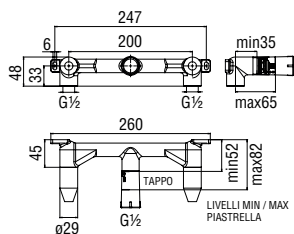
RVT200/5D  
18,00 €RVT200/5S  
18,00 €RAEK222/44  
61,00 € - 10 pz.NR00212/28  
41,00 €**Allbox, parte incasso necessaria**

- Ingresso acqua calda e acqua fredda ø 1/2"
- Uscita ø 1/2"

- WE00298 130,00 €

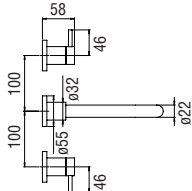
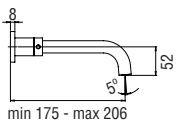
**Parte esterna batteria 3 fori a parete con bocca lunga**

- Aeratore anticalcare M 18,5 x 1, portata 5 l/min
- Lunghezza bocca min 175 - max 206 mm
- Senza scarico

Cromo lucido	VE125298/1ECR	332,00 €
Inox spazzolato	VE125298/1EIX	498,00 €
Grafite spazzolato PVD	VE125298/1EGUP	630,00 €
Miele spazzolato PVD	VE125298/1ECGP	<b>NEW</b> 630,00 €
Caffè spazzolato	VE125298/1ESB	<b>NEW</b> 630,00 €
Tramonto lucido PVD	VE125298/1ERCP	630,00 €
Argilla spazzolato PVD	VE125298/1ERTP	630,00 €

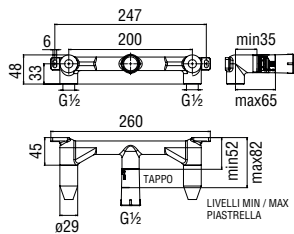
RVT200/5D  
18,00 €RVT200/5S  
18,00 €RAEK222/44  
61,00 € - 10 pz.NR00212/28  
41,00 €**Allbox, parte incasso necessaria**

- Ingresso acqua calda e acqua fredda ø 1/2"
- Uscita ø 1/2"

- WE00298 130,00 €

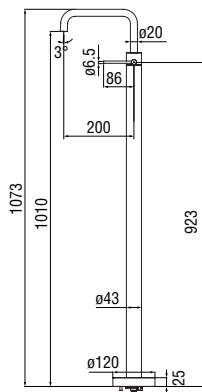

**Monocomando**

- Limitatore di energia con apertura in acqua fredda
- Aeratore anticalcare M 18 x 1, portata 5 l/min
- Bocca girevole
- Senza scarico

Cromo lucido	VE125188/3CR	736,00 €
Inox spazzolato	VE125188/3IX	1.105,00 €
Grafite spazzolato PVD	VE125188/3GUP	1.178,00 €
Miele spazzolato PVD	VE125188/3CGP	<b>NEW</b> 1.178,00 €
Caffè spazzolato	VE125188/3SB	<b>NEW</b> 1.178,00 €
Tramonto lucido PVD	VE125188/3RCP	1.178,00 €
Argilla spazzolato PVD	VE125188/3RTP	1.178,00 €



RCR2020  
41,00 €



RAEK222/42  
45,00 € - 10 pz.

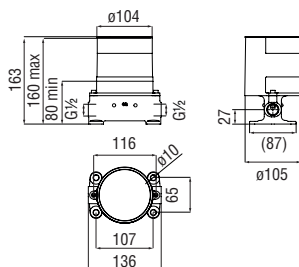

**Parte incasso necessaria**

- Ingresso acqua calda e acqua fredda ø 1/2"

- WE77250 **MOD** 291,00 €

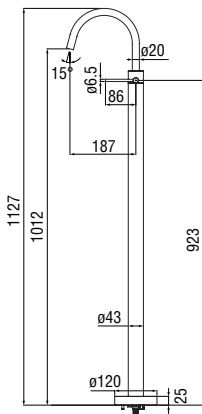

**Monocomando**

- Limitatore di energia con apertura in acqua fredda
- Aeratore anticalcare M 18 x 1, portata 5 l/min
- Bocca girevole
- Senza scarico

Cromo lucido	VE125189/3CR	736,00 €
Inox spazzolato	VE125189/3IX	1.105,00 €
Grafite spazzolato PVD	VE125189/3GUP	1.178,00 €
Miele spazzolato PVD	VE125189/3CGP	<b>NEW</b> 1.178,00 €
Caffè spazzolato	VE125189/3SB	<b>NEW</b> 1.178,00 €
Tramonto lucido PVD	VE125189/3RCP	1.178,00 €
Argilla spazzolato PVD	VE125189/3RTP	1.178,00 €



RCR2020  
41,00 €



RAEK222/42  
45,00 € - 10 pz.

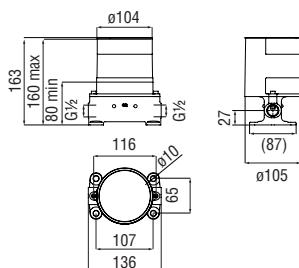

**Parte incasso necessaria**

- Ingresso acqua calda e acqua fredda ø 1/2"

- WE77250 **MOD** 291,00 €

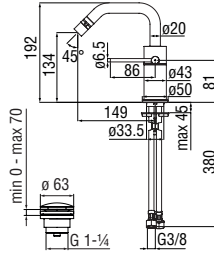

**Monocomando**

- Limitatore di energia con apertura in acqua fredda
- Aeratore anticalcare M 16 x 1, portata 5 l/min
- Bocca girevole, getto orientabile
- Scarico 1 1/4" push, flessibili inox ø 3/8"

Cromo lucido	VE125119/2CR	352,00 €
Inox spazzolato	VE125119/2IX	528,00 €
Grafite spazzolato PVD	VE125119/2GUP	563,00 €
Miele spazzolato PVD	VE125119/2CGP	<b>NEW</b> 563,00 €
Caffè spazzolato	VE125119/2SB	<b>NEW</b> 563,00 €
Tramonto lucido PVD	VE125119/2RCP	563,00 €
Argilla spazzolato PVD	VE125119/2RTP	563,00 €

 RCR2020  
41,00 €

 RAE222/43CR  
29,00 € - 1 pz.

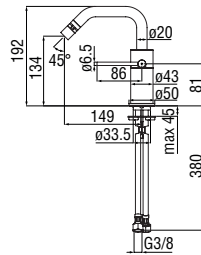

**Monocomando**

- Limitatore di energia con apertura in acqua fredda
- Aeratore anticalcare M 16 x 1, portata 5 l/min
- Bocca girevole, getto orientabile
- Senza scarico, flessibili inox ø 3/8"

Cromo lucido	VE125119/3CR	335,00 €
Inox spazzolato	VE125119/3IX	503,00 €
Grafite spazzolato PVD	VE125119/3GUP	536,00 €
Miele spazzolato PVD	VE125119/3CGP	<b>NEW</b> 536,00 €
Caffè spazzolato	VE125119/3SB	<b>NEW</b> 536,00 €
Tramonto lucido PVD	VE125119/3RCP	536,00 €
Argilla spazzolato PVD	VE125119/3RTP	536,00 €

 RCR2020  
41,00 €

 RAE222/43CR  
29,00 € - 1 pz.

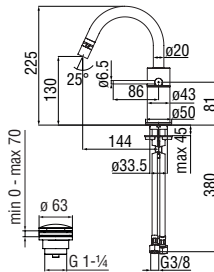

**Monocomando**

- Limitatore di energia con apertura in acqua fredda
- Aeratore anticalcare M 16 x 1, portata 5 l/min
- Bocca girevole, getto orientabile
- Scarico 1 1/4" push, flessibili inox ø 3/8"

Cromo lucido	VE125139/2CR	352,00 €
Inox spazzolato	VE125139/2IX	528,00 €
Grafite spazzolato PVD	VE125139/2GUP	563,00 €
Miele spazzolato PVD	VE125139/2CGP	<b>NEW</b> 563,00 €
Caffè spazzolato	VE125139/2SB	<b>NEW</b> 563,00 €
Tramonto lucido PVD	VE125139/2RCP	563,00 €
Argilla spazzolato PVD	VE125139/2RTP	563,00 €

 RCR2020  
41,00 €

 RAE222/43CR  
29,00 € - 1 pz.

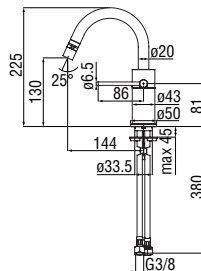

**Monocomando**

- Limitatore di energia con apertura in acqua fredda
- Aeratore anticalcare M 16 x 1, portata 5 l/min
- Bocca girevole, getto orientabile
- Senza scarico, flessibili inox ø 3/8"

Cromo lucido	VE125139/3CR	335,00 €
Inox spazzolato	VE125139/3IX	503,00 €
Grafite spazzolato PVD	VE125139/3GUP	536,00 €
Miele spazzolato PVD	VE125139/3CGP	<b>NEW</b> 536,00 €
Caffè spazzolato	VE125139/3SB	<b>NEW</b> 536,00 €
Tramonto lucido PVD	VE125139/3RCP	536,00 €
Argilla spazzolato PVD	VE125139/3RTP	536,00 €

 RCR2020  
41,00 €

 RAE222/43CR  
29,00 € - 1 pz.

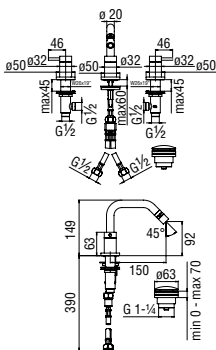

**Batteria 3 fori**

- Aeratore anticalcare M 16 x 1, portata 5 l/min
- Getto orientabile
- Scarico 1 1/4" push

Cromo lucido	VE125215/2CR	472,00 €
Inox spazzolato	VE125215/2IX	709,00 €
Grafite spazzolato PVD	VE125215/2GUP	787,00 €
Miele spazzolato PVD	VE125215/2CGP	<b>NEW</b> 787,00 €
Caffè spazzolato	VE125215/2SB	<b>NEW</b> 787,00 €
Tramonto lucido PVD	VE125215/2RCP	787,00 €
Argilla spazzolato PVD	VE125215/2RTP	787,00 €

RVT200/5D 18,00 €	RVT200/5S 18,00 €	RAE222/43CR 29,00 € - 1 pz.

VASCA A PAVIMENTO

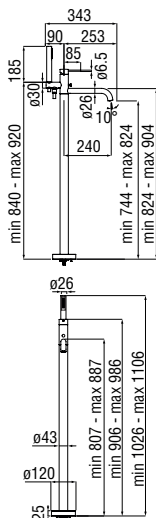

**Parte esterna monocomando a 2 vie**

- Aeratore anticalcare M 24 x 1
- Deviatore con ritorno automatico
- Doccetta monogetto e flessibile 150 cm

Cromo lucido	WE00180/VECR	<b>MOD</b>	1.373,00 €
Inox spazzolato	WE00180/VEIX	<b>MOD</b>	2.062,00 €
Grafite spazzolato PVD	WE00180/VEGUP	<b>MOD</b>	2.200,00 €
Miele spazzolato PVD	WE00180/VECGP	<b>NEW</b>	2.200,00 €
Caffè spazzolato	WE00180/VESB	<b>NEW</b>	2.200,00 €
Tramonto lucido PVD	WE00180/VERCP	<b>MOD</b>	2.200,00 €
Argilla spazzolato PVD	WE00180/VERTP	<b>MOD</b>	2.200,00 €

CARTRIDGE WARRANTY	RCR350 39,00 €	RAEK222/22 45,00 € - 10 pz.

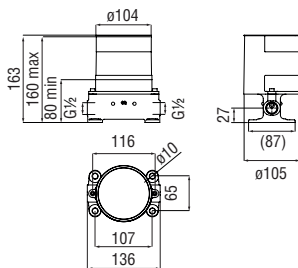

**Parte incasso necessaria**

- Ingresso acqua calda e acqua fredda ø 1/2"

-	WE77250	<b>MOD</b>	291,00 €
---	---------	------------	----------

BORDO VASCA

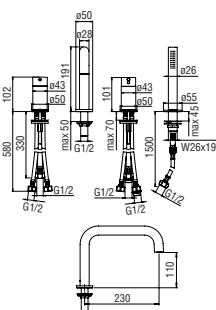

**Monocomando bordo vasca**

- Limitatore di portata con freno al 50%
- Aeratore anticalcare M 24 x 1
- Deviatore a 2 vie
- Doccetta monogetto estraibile

Cromo lucido	WEBK110/9VECR	777,00 €
Inox spazzolato	WEBK110/9VEIX	1.165,00 €
Grafite spazzolato PVD	WEBK110/9VEGUP	1.260,00 €
Miele spazzolato PVD	WEBK110/9VECGP	<b>NEW</b> 1.260,00 €
Caffè spazzolato	WEBK110/9VESB	<b>NEW</b> 1.260,00 €
Tramonto lucido PVD	WEBK110/9VERCP	1.260,00 €
Argilla spazzolato PVD	WEBK110/9VERTP	1.260,00 €

CARTRIDGE WARRANTY	RCR350 39,00 €	RCR201/35FSC 39,00 €	RAEK222/22 45,00 € - 10 pz.

**Batteria 5 fori bordo vasca**

- Aeratore anticalcare M 24 x 1
- Deviatore a 2 vie
- Doccetta monogetto estraibile

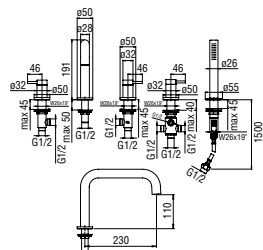

Cromo lucido	WEBK204/VECR	945,00 €
Inox spazzolato	WEBK204/VEIX	1.418,00 €
Grafite spazzolato PVD	WEBK204/VEGUP	1.522,00 €
Miele spazzolato PVD	WEBK204/VECGP	<b>NEW</b> 1.522,00 €
Caffè spazzolato	WEBK204/VESB	<b>NEW</b> 1.522,00 €
Tramonto lucido PVD	WEBK204/VERCP	1.522,00 €
Argilla spazzolato PVD	WEBK204/VERTP	1.522,00 €



RVT200/5D  
18,00 €



RVT200/5S  
18,00 €



RAEK222/22  
45,00 € - 10 pz.

VASCA

**Monocomando esterno con set doccia**

- Limitatore di portata con freno al 50%
- Aeratore anticalcare M 24 x 1
- Deviatore con ritorno automatico
- Doccetta monogetto e flessibile 150 cm

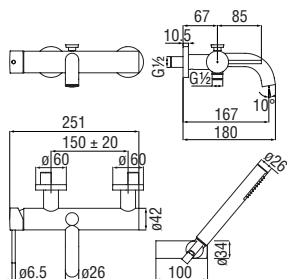

Cromo lucido	VEI25110CR	393,00 €
Inox spazzolato	VEI25110IX	589,00 €
Grafite spazzolato PVD	VEI25110GUP	629,00 €
Miele spazzolato PVD	VEI25110CGP	<b>NEW</b> 629,00 €
Caffè spazzolato	VEI25110SB	<b>NEW</b> 629,00 €
Tramonto lucido PVD	VEI25110RCP	629,00 €
Argilla spazzolato PVD	VEI25110RTP	629,00 €



CARTRIDGE  
WARRANTY



RCR350  
39,00 €



RAEK222/22  
45,00 € - 10 pz.

**Monocomando esterno**

- Limitatore di portata con freno al 50%
- Aeratore anticalcare M 24 x 1
- Deviatore con ritorno automatico
- Uscita ø 1/2"

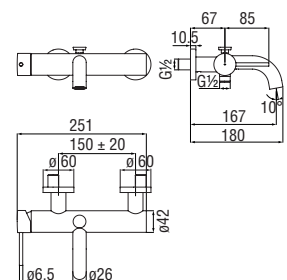

Cromo lucido	VEI25110/1CR	369,00 €
Inox spazzolato	VEI25110/1IX	552,00 €
Grafite spazzolato PVD	VEI25110/1GUP	589,00 €
Miele spazzolato PVD	VEI25110/1CGP	<b>NEW</b> 589,00 €
Caffè spazzolato	VEI25110/1SB	<b>NEW</b> 589,00 €
Tramonto lucido PVD	VEI25110/1RCP	589,00 €
Argilla spazzolato PVD	VEI25110/1RTP	589,00 €



CARTRIDGE  
WARRANTY



RCR350  
39,00 €



RAEK222/22  
45,00 € - 10 pz.

**Termostatico esterno con set doccia**

- Blocco di sicurezza 38° C
- Valvole antiritorno
- Aeratore anticalcare M 24 x 1
- Doccetta monogetto e flessibile 150 cm

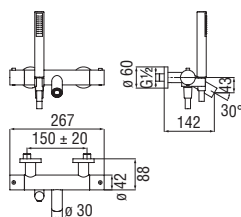

Cromo lucido	VEI25010/2CR	692,00 €
Inox spazzolato	VEI25010/2IX	1.038,00 €
Grafite spazzolato PVD	VEI25010/2GUP	1.107,00 €
Miele spazzolato PVD	VEI25010/2CGP	<b>NEW</b> 1.107,00 €
Caffè spazzolato	VEI25010/2SB	<b>NEW</b> 1.107,00 €
Tramonto lucido PVD	VEI25010/2RCP	1.107,00 €
Argilla spazzolato PVD	VEI25010/2RTP	1.107,00 €



RCR201/56  
58,00 €



RCR201/57  
51,00 €



RAEK222/22  
45,00 € - 10 pz.

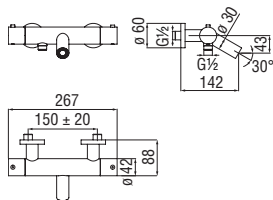

**Termostatico esterno**

- Blocco di sicurezza 38° C
- Valvoline antiritorno
- Aeratore anticalcare M 24 x 1
- Uscita ø 1/2"

Cromo lucido	VE125010/1CR	611,00 €
Inox spazzolato	VE125010/1IX	918,00 €
Grafite spazzolato PVD	VE125010/1GUP	978,00 €
Miele spazzolato PVD	VE125010/1CGP	<b>NEW</b> 978,00 €
Caffè spazzolato	VE125010/1SB	<b>NEW</b> 978,00 €
Tramonto lucido PVD	VE125010/1RCP	978,00 €
Argilla spazzolato PVD	VE125010/1RTP	978,00 €



RCR201/56  
58,00 €



RCR201/57  
51,00 €



RAEK222/22  
45,00 € - 10 pz.

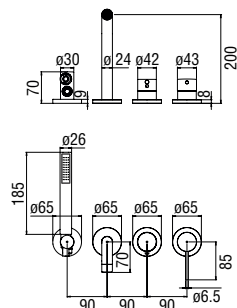

**Parte esterna monocomando incasso a 2 vie**

- Limitatore di portata con freno al 50%
- Deviatore a 2 vie
- Aeratore anticalcare M 22 x 1
- Doccetta monogetto e flessibile 150 cm

Cromo lucido	WEBK110/91VECR	524,00 €
Inox spazzolato	WEBK110/91VEIX	784,00 €
Grafite spazzolato PVD	WEBK110/91VEGUP	837,00 €
Miele spazzolato PVD	WEBK110/91VECGP	<b>NEW</b> 837,00 €
Caffè spazzolato	WEBK110/91VESB	<b>NEW</b> 837,00 €
Tramonto lucido PVD	WEBK110/91VERCP	837,00 €
Argilla spazzolato PVD	WEBK110/91VERTP	837,00 €



RAEK220/36CR  
53,00 € - 10 pz.



NR00212/22CR  
85,00 €

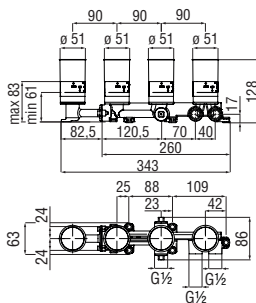

**Parte incasso necessaria**

- Ingresso e uscita acqua ø 1/2"

-	WE81201/T	<b>NEW</b> 390,00 €
---	-----------	---------------------



CARTRIDGE  
WARRANTY



RCR350  
39,00 €



RCR201/35FSC  
39,00 €



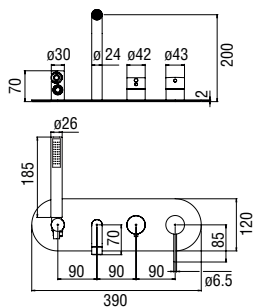

**Parte esterna monocomando incasso a 2 vie**

- Limitatore di portata con freno al 50%
- Deviatore a 2 vie
- Aeratore anticalcare M 22 x 1
- Doccetta monogetto e flessibile 150 cm

Cromo lucido	WEBK110/90VECR	524,00 €
Inox spazzolato	WEBK110/90VEIX	784,00 €
Grafite spazzolato PVD	WEBK110/90VEGUP	837,00 €
Miele spazzolato PVD	WEBK110/90VECGP <b>NEW</b>	837,00 €
Caffè spazzolato	WEBK110/90VESB <b>NEW</b>	837,00 €
Tramonto lucido PVD	WEBK110/90VERCP	837,00 €
Argilla spazzolato PVD	WEBK110/90VERTP	837,00 €

RAEK220/36CR 53,00 € - 10 pz.  
 NR00212/22CR 85,00 €

**Parte incasso necessaria**

- Ingresso e uscita acqua ø 1/2"

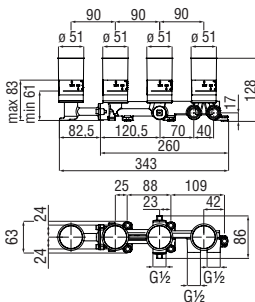

-	WE81201/T	<b>NEW</b>	390,00 €
---	-----------	------------	----------

CARTRIDGE WARRANTY  
 RCR350 39,00 €  
 RCR201/35FSC 39,00 €

**Bocca a parete**

- Aeratore anticalcare M 22 x 1
- Lunghezza 200 mm

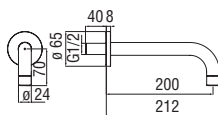

Cromo lucido	AV00158/36CR	103,00 €
Inox spazzolato	AV00158/36IX	155,00 €
Grafite spazzolato PVD	AV00158/36GUP	164,00 €
Miele spazzolato PVD	AV00158/36CGP <b>NEW</b>	164,00 €
Caffè spazzolato	AV00158/36SB <b>NEW</b>	164,00 €
Tramonto lucido PVD	AV00158/36RCP	164,00 €
Argilla spazzolato PVD	AV00158/36RTP	164,00 €

RAEK220/36CR 53,00 € - 10 pz.

DOCCIA

**Monocomando esterno**

- Limitatore di portata con freno al 50%
- Uscita ø 1/2"

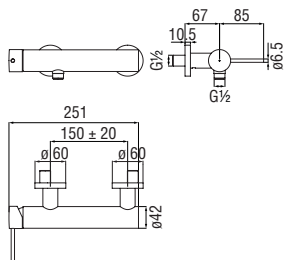

Cromo lucido	VE125130CR	264,00 €
Inox spazzolato	VE125130IX	396,00 €
Grafite spazzolato PVD	VE125130GUP	422,00 €
Miele spazzolato PVD	VE125130CGP <b>NEW</b>	422,00 €
Caffè spazzolato	VE125130SB <b>NEW</b>	422,00 €
Tramonto lucido PVD	VE125130RCP	422,00 €
Argilla spazzolato PVD	VE125130RTP	422,00 €

CARTRIDGE WARRANTY  
 RCR350 39,00 €

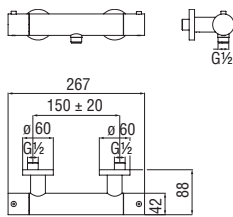
**Termostatico esterno**

- Blocco di sicurezza 38° C
- Valvole antiritorno
- Uscita ø 1/2"

Cromo lucido	VE125030CR	487,00 €
Inox spazzolato	VE125030IX	732,00 €
Grafite spazzolato PVD	VE125030GUP	779,00 €
Miele spazzolato PVD	VE125030CGP	<b>NEW</b> 779,00 €
Caffè spazzolato	VE125030SB	<b>NEW</b> 779,00 €
Tramonto lucido PVD	VE125030RCP	779,00 €
Argilla spazzolato PVD	VE125030RTP	779,00 €



RCR201/56  
58,00 €

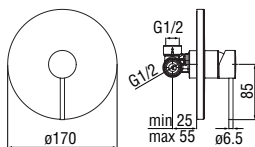

RVT200/28  
21,00 €

**Monocomando incasso a 1 via**

- Limitatore di portata con freno al 50%
- Tenuta o-ring invisibile, fissaggio a parete impermeabile
- Ingresso e uscita acqua ø 1/2"
- Parte esterna e parte incasso

Cromo lucido	VE125108CR	240,00 €
Inox spazzolato	VE125108IX	361,00 €
Grafite spazzolato PVD	VE125108GUP	386,00 €
Miele spazzolato PVD	VE125108CGP	<b>NEW</b> 386,00 €
Caffè spazzolato	VE125108SB	<b>NEW</b> 386,00 €
Tramonto lucido PVD	VE125108RCP	386,00 €
Argilla spazzolato PVD	VE125108RTP	386,00 €



CARTRIDGE  
WARRANTY



RCR350  
39,00 €

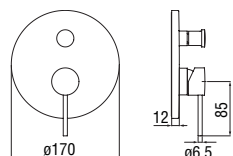

NR00212/10CR  
43,00 €

**Parte esterna monocomando incasso a 2 vie**

- Limitatore di portata con freno al 50%
- Deviatore con ritorno automatico
- Tenuta o-ring invisibile, fissaggio a parete impermeabile

Cromo lucido	VE125100/ECR	230,00 €
Inox spazzolato	VE125100/EIX	347,00 €
Grafite spazzolato PVD	VE125100/EGUP	370,00 €
Miele spazzolato PVD	VE125100/ECGP	<b>NEW</b> 370,00 €
Caffè spazzolato	VE125100/ESB	<b>NEW</b> 370,00 €
Tramonto lucido PVD	VE125100/ERCP	370,00 €
Argilla spazzolato PVD	VE125100/ERTP	370,00 €

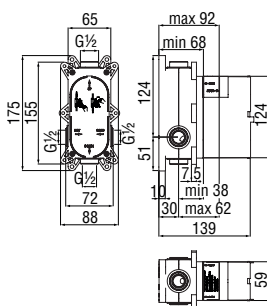

NR00212/13CR  
57,00 €

**Easybox 2 vie, parte incasso necessaria**

- Ingresso e uscita acqua ø 1/2"
- Adatta anche a montaggio su cartongesso

Nota: disponibile il dispositivo antireflusso RVRENI717 (opzionale)

-	WE81100	135,00 €
---	---------	----------



CARTRIDGE  
WARRANTY



RCR350  
39,00 €

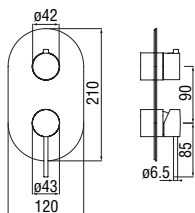

RVRENI717  
33,00 €

**Parte esterna monocomando incasso a 2-3 vie**

- Limitatore di portata con freno al 50%
- Tenuta o-ring invisibile, fissaggio a parete impermeabile

Cromo lucido	WE81102/VECR	413,00 €
Inox spazzolato	WE81102/VEIX	618,00 €
Grafite spazzolato PVD	WE81102/VEGUP	660,00 €
Miele spazzolato PVD	WE81102/VEGCP	<b>NEW</b> 660,00 €
Caffè spazzolato	WE81102/VESB	<b>NEW</b> 660,00 €
Tramonto lucido PVD	WE81102/VERCP	660,00 €
Argilla spazzolato PVD	WE81102/VERTP	660,00 €

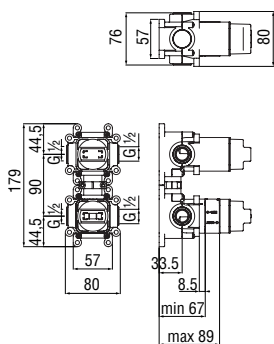
**Techbox 2 vie, parte incasso necessaria**

- Deviatore a 2 vie ceramico
- Ingresso e uscita acqua  $\varnothing$  1/2"
- Adatta anche a montaggio su cartongesso

- WE81102 160,00 €



CARTRIDGE  
WARRANTY



RCR350  
39,00 €



RCR201/35FSC  
39,00 €

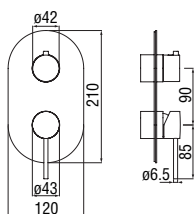

NR00212/30  
85,00 €

**Parte esterna monocomando incasso a 2-3 vie**

- Limitatore di portata con freno al 50%
- Tenuta o-ring invisibile, fissaggio a parete impermeabile

Cromo lucido	WE81102/VECR	413,00 €
Inox spazzolato	WE81102/VEIX	618,00 €
Grafite spazzolato PVD	WE81102/VEGUP	660,00 €
Miele spazzolato PVD	WE81102/VEGCP	<b>NEW</b> 660,00 €
Caffè spazzolato	WE81102/VESB	<b>NEW</b> 660,00 €
Tramonto lucido PVD	WE81102/VERCP	660,00 €
Argilla spazzolato PVD	WE81102/VERTP	660,00 €

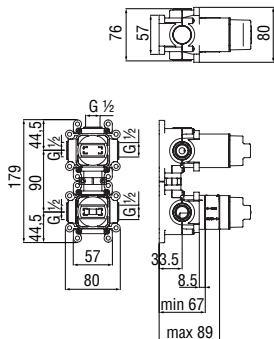
**Techbox 3 vie, parte incasso necessaria**

- Deviatore a 3 vie ceramico
- Ingresso e uscita acqua  $\varnothing$  1/2"
- Adatta anche a montaggio su cartongesso

- WE81103 184,00 €



CARTRIDGE  
WARRANTY



RCR350  
39,00 €



RCR201/35C  
39,00 €

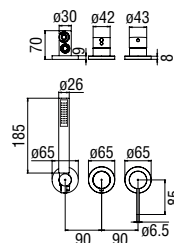

NR00212/32  
85,00 €

**Parte esterna monocomando incasso a 2 vie**

- Limitatore di portata con freno al 50%
- Doccetta monogetto e flessibile 150 cm
- Deviatore a 2 vie
- Abbinamento libero per la seconda via

Cromo lucido	WESK100/IVECR	431,00 €
Inox spazzolato	WESK100/IVEIX	645,00 €
Grafite spazzolato PVD	WESK100/IVEGUP	688,00 €
Miele spazzolato PVD	WESK100/IVECGP	<b>NEW</b> 688,00 €
Caffè spazzolato	WESK100/IVESB	<b>NEW</b> 688,00 €
Tramonto lucido PVD	WESK100/IVERCP	688,00 €
Argilla spazzolato PVD	WESK100/IVERTP	688,00 €



NR00212/22CR  
85,00 €

**Parte incasso necessaria**

- Ingresso e uscita acqua  $\varnothing$  1/2"

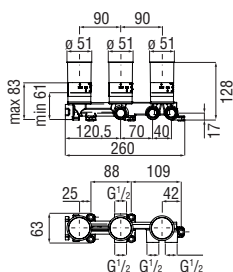

- WE81200/T **NEW** 334,00 €



CARTRIDGE  
WARRANTY



RCR350  
39,00 €

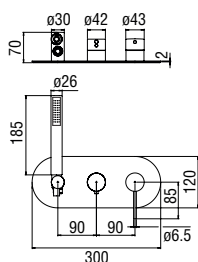

RCR201/35FSC  
39,00 €

**Parte esterna monocomando incasso a 2 vie**

- Limitatore di portata con freno al 50%
- Doccetta monogetto e flessibile 150 cm
- Deviatore a 2 vie
- Abbinamento libero per la seconda via

Cromo lucido	WESK100/VECR	431,00 €
Inox spazzolato	WESK100/VEIX	645,00 €
Grafite spazzolato PVD	WESK100/VEGUP	688,00 €
Miele spazzolato PVD	WESK100/VECGP	<b>NEW</b> 688,00 €
Caffè spazzolato	WESK100/VESB	<b>NEW</b> 688,00 €
Tramonto lucido PVD	WESK100/VERCP	688,00 €
Argilla spazzolato PVD	WESK100/VERTP	688,00 €



NR00212/22CR  
85,00 €

**Parte incasso necessaria**

- Ingresso e uscita acqua  $\varnothing$  1/2"

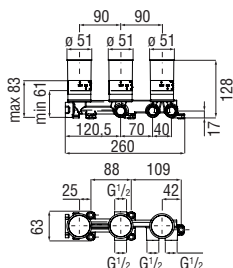

- WE81200/T **NEW** 334,00 €



CARTRIDGE  
WARRANTY



RCR350  
39,00 €



RCR201/35FSC  
39,00 €

**Coppia di rubinetti d'arresto a incasso**

- Ingresso a 2 vie
- Uscite  $\varnothing 1/2''$



Cromo lucido	VEK125208CR	168,00 €
Inox spazzolato	VEK125208IX	252,00 €
Grafite spazzolato PVD	VEK125208GUP	269,00 €
Miele spazzolato PVD	VEK125208CGP	<b>NEW</b> 269,00 €
Caffè spazzolato	VEK125208SB	<b>NEW</b> 269,00 €
Tramonto lucido PVD	VEK125208RCP	269,00 €
Argilla spazzolato PVD	VEK125208RTP	269,00 €



RVT200/5D  
18,00 €



RVT200/5S  
18,00 €



NR00212/26  
38,00 €

**Deviatore 2 vie**

- Ingresso a 2 vie
- Uscite  $\varnothing 1/2''$



Cromo lucido	VEI25160CR	162,00 €
Inox spazzolato	VEI25160IX	243,00 €
Grafite spazzolato PVD	VEI25160GUP	258,00 €
Miele spazzolato PVD	VEI25160CGP	<b>NEW</b> 258,00 €
Caffè spazzolato	VEI25160SB	<b>NEW</b> 258,00 €
Tramonto lucido PVD	VEI25160RCP	258,00 €
Argilla spazzolato PVD	VEI25160RTP	258,00 €



NR00212/27  
24,00 €

**TERMOSTATICI INCASSO****Parte esterna termostatico a 1 via**

- Blocco di sicurezza 38° C
- Montaggio verticale o orizzontale

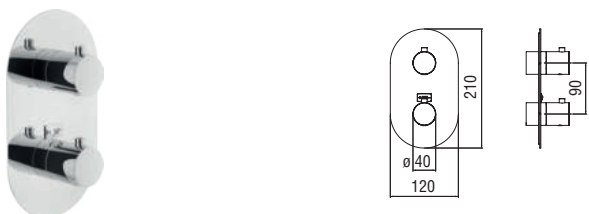

Cromo lucido	WE00101/TCR	414,00 €
Inox spazzolato	WE00101/TIX	621,00 €
Grafite spazzolato PVD	WE00101/TGUP	662,00 €
Miele spazzolato PVD	WE00101/TCGP	<b>NEW</b> 662,00 €
Caffè spazzolato	WE00101/TSB	<b>NEW</b> 662,00 €
Tramonto lucido PVD	WE00101/TRCP	662,00 €
Argilla spazzolato PVD	WE00101/TRTP	662,00 €



NR00008  
34,00 €

**Wellbox 1 via, parte incasso necessaria**

- Ingresso e uscita acqua  $\varnothing 1/2''$
- Rubinetti di chiusura
- Valvole antiritorno
- Adatta anche a montaggio su cartongesso
- Filtri di ricambio cartuccia inclusi nella confezione

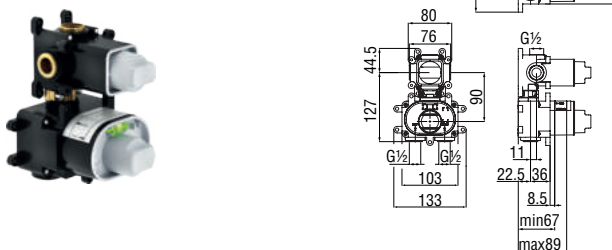

-	WE00101	167,00 €
---	---------	----------



RCR201/5  
58,00 €



RVT200/5D  
18,00 €

**Parte esterna termostatico a 2 vie**

- Blocco di sicurezza 38° C
- Montaggio verticale o orizzontale

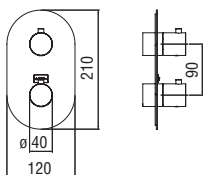

Cromo lucido	WE00102/TCR	414,00 €
Inox spazzolato	WE00102/TIX	621,00 €
Grafite spazzolato PVD	WE00102/TGUP	662,00 €
Miele spazzolato PVD	WE00102/TCGP	<b>NEW</b> 662,00 €
Caffè spazzolato	WE00102/TSB	<b>NEW</b> 662,00 €
Tramonto lucido PVD	WE00102/TRCP	662,00 €
Argilla spazzolato PVD	WE00102/TRTP	662,00 €



NR00008  
34,00 €

**Wellbox 2 vie, parte incasso necessaria**

- Ingresso e uscita acqua ø 1/2"
- Rubinetti di chiusura
- Valvoline antiritorno
- Adatta anche a montaggio su cartongesso
- Filtri di ricambio cartuccia inclusi nella confezione

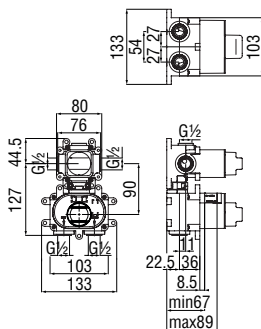

-	WE00102	215,00 €
---	---------	----------



RCR201/5  
58,00 €



RCR201/28  
39,00 €

**Parte esterna termostatico a 3 vie**

- Blocco di sicurezza 38° C
- Montaggio verticale o orizzontale

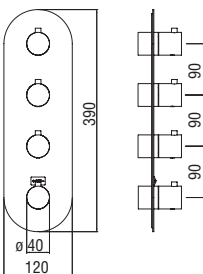

Cromo lucido	WE00103/TCR	856,00 €
Inox spazzolato	WE00103/TIX	1.283,00 €
Grafite spazzolato PVD	WE00103/TGUP	1.368,00 €
Miele spazzolato PVD	WE00103/TCGP	<b>NEW</b> 1.368,00 €
Caffè spazzolato	WE00103/TSB	<b>NEW</b> 1.368,00 €
Tramonto lucido PVD	WE00103/TRCP	1.368,00 €
Argilla spazzolato PVD	WE00103/TRTP	1.368,00 €



NR00008  
34,00 €

**Wellbox 3 vie, parte incasso necessaria**

- Ingresso e uscita acqua ø 1/2"
- Rubinetti di chiusura
- Valvoline antiritorno
- Adatta anche a montaggio su cartongesso
- Filtri di ricambio cartuccia inclusi nella confezione

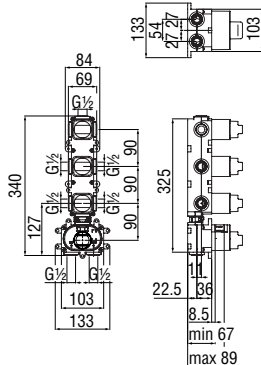

-	WE00103	318,00 €
---	---------	----------



RCR201/5  
58,00 €



RVT200/5D  
18,00 €

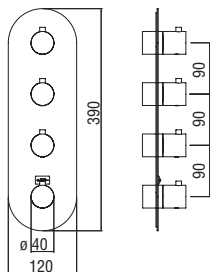

**Parte esterna termostatico a 4 vie**

- Blocco di sicurezza 38° C
- Montaggio verticale o orizzontale

Cromo lucido	WE00104/TCR	856,00 €
Inox spazzolato	WE00104/TIX	1.283,00 €
Grafite spazzolato PVD	WE00104/TGUP	1.368,00 €
Miele spazzolato PVD	WE00104/TCGP	<b>NEW</b> 1.368,00 €
Caffè spazzolato	WE00104/TSB	<b>NEW</b> 1.368,00 €
Tramonto lucido PVD	WE00104/TRCP	1.368,00 €
Argilla spazzolato PVD	WE00104/TRTP	1.368,00 €

NR00008  
34,00 €

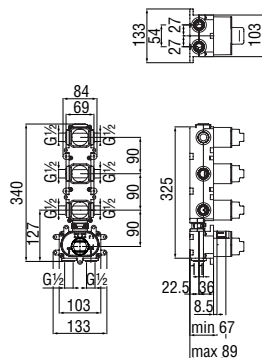

**Wellbox 4 vie, parte incasso necessaria**

- Ingresso e uscita acqua ø 1/2"
- Rubinetti di chiusura
- Valvole antiritorno
- Adatta anche a montaggio su cartongesso
- Filtri di ricambio cartuccia inclusi nella confezione

-	WE00104	360,00 €
---	---------	----------

RCR201/5 58,00 €     RCR201/28 39,00 €     RVT200/5D 18,00 €

BRACCI DOCCIA

**Braccio a parete**

- Lunghezza 350 mm

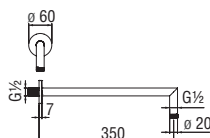

Cromo lucido	AD138/44CR	90,00 €
Inox spazzolato	AD138/44IX	135,00 €
Grafite spazzolato PVD	AD138/44GUP	146,00 €
Miele spazzolato PVD	AD138/44CGP	<b>NEW</b> 146,00 €
Caffè spazzolato	AD138/44SB	<b>NEW</b> 146,00 €
Tramonto lucido PVD	AD138/44RCP	146,00 €
Argilla spazzolato PVD	AD138/44RTP	146,00 €

**Braccio a soffitto**

- Lunghezza 300 mm

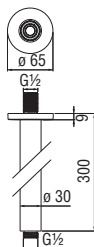

Cromo lucido	AD138/64CR	149,00 €
Inox spazzolato	AD138/64IX	223,00 €
Grafite spazzolato PVD	AD138/64GUP	238,00 €
Miele spazzolato PVD	AD138/64CGP	<b>NEW</b> 238,00 €
Caffè spazzolato	AD138/64SB	<b>NEW</b> 238,00 €
Tramonto lucido PVD	AD138/64RCP	238,00 €
Argilla spazzolato PVD	AD138/64RTP	238,00 €



**Soffione a snodo (Abs)**

- Dimensione ø 300 mm
- Getto pioggia



Cromo lucido	AD139/63CR		314,00 €
Inox spazzolato	AD139/63IX		471,00 €
Grafite spazzolato PVD	AD139/63GUP		566,00 €
Miele spazzolato PVD	AD139/63CGP	NEW	566,00 €
Caffè spazzolato	AD139/63SB	NEW	566,00 €
Tramonto lucido PVD	AD139/63RCP		566,00 €
Argilla spazzolato PVD	AD139/63RTP		566,00 €

BODYJET

**Bodyjet esterno**

- Getto pioggia orientabile



Cromo lucido	WE00139/81CR		158,00 €
Inox spazzolato	WE00139/81IX		236,00 €
Grafite spazzolato PVD	WE00139/81GUP		251,00 €
Miele spazzolato PVD	WE00139/81CGP	NEW	251,00 €
Caffè spazzolato	WE00139/81SB	NEW	251,00 €
Tramonto lucido PVD	WE00139/81RCP		251,00 €
Argilla spazzolato PVD	WE00139/81RTP		251,00 €

SET DOCCIA

**Set doccia con presa acqua ø 1/2"**

- Supporto doccetta fisso rivestito in Teflon
- Doccetta monogetto e flessibile 150 cm

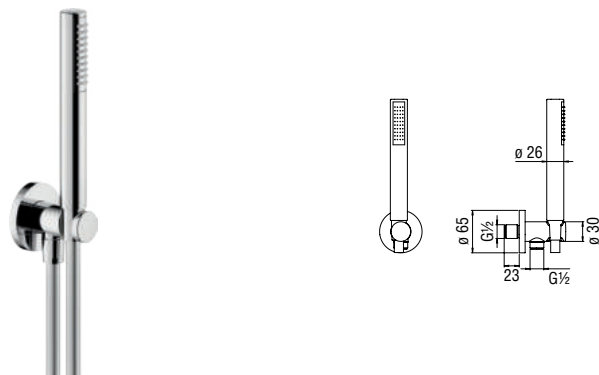

Cromo lucido	AD146/32CR		116,00 €
Inox spazzolato	AD146/32IX		172,00 €
Grafite spazzolato PVD	AD146/32GUP		184,00 €
Miele spazzolato PVD	AD146/32CGP	NEW	184,00 €
Caffè spazzolato	AD146/32SB	NEW	184,00 €
Tramonto lucido PVD	AD146/32RCP		184,00 €
Argilla spazzolato PVD	AD146/32RTP		184,00 €

**Set doccia**

- Supporto doccetta orientabile
- Doccetta monogetto e flessibile 150 cm

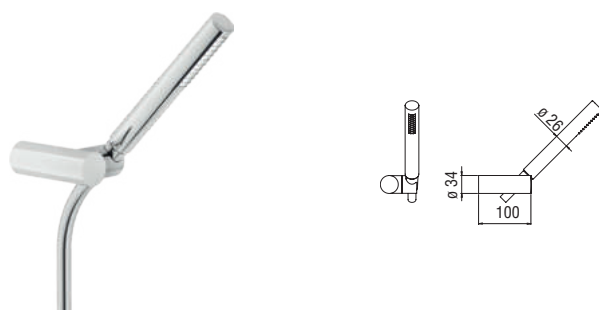

Cromo lucido	AD146/26CR		89,00 €
Inox spazzolato	AD146/26IX		135,00 €
Grafite spazzolato PVD	AD146/26GUP		144,00 €
Miele spazzolato PVD	AD146/26CGP	NEW	144,00 €
Caffè spazzolato	AD146/26SB	NEW	144,00 €
Tramonto lucido PVD	AD146/26RCP		144,00 €
Argilla spazzolato PVD	AD146/26RTP		144,00 €

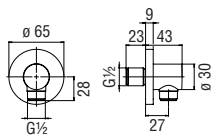
**Presca acqua**· Uscita  $\varnothing$  1/2"

Cromo lucido	AD150/12CR		48,00 €
Inox spazzolato	AD150/12IX		74,00 €
Grafite spazzolato PVD	AD150/12GUP		79,00 €
Miele spazzolato PVD	AD150/12CGP	<b>NEW</b>	79,00 €
Caffè spazzolato	AD150/12SB	<b>NEW</b>	79,00 €
Tramonto lucido PVD	AD150/12RCP		79,00 €
Argilla spazzolato PVD	AD150/12RTP		79,00 €

## ASTE MURALI

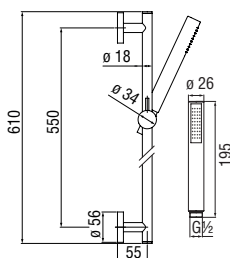
**Asta murale**

- Supporto doccetta scorrevole e orientabile
- Doccetta monogetto e flessibile 150 cm

Cromo lucido	AD140/37CR		139,00 €
Inox spazzolato	AD140/37IX		208,00 €
Grafite spazzolato PVD	AD140/37GUP		223,00 €
Miele spazzolato PVD	AD140/37CGP	<b>NEW</b>	223,00 €
Caffè spazzolato	AD140/37SB	<b>NEW</b>	223,00 €
Tramonto lucido PVD	AD140/37RCP		223,00 €
Argilla spazzolato PVD	AD140/37RTP		223,00 €

RUBINETTERIA NOBILI

# DRESS

Nilo Gioacchini

La sintesi formale di Dress non si limita a completare l'arredo bagno, ma si evolve a progetto più ampio e completo in grado di coordinare sensazioni visive e tattili scegliendo fra un'ampia gamma di superfici per leva e bocca di erogazione. Nella versione Inox T.E.A.+® il miscelatore riceve un processo galvanico all'avanguardia in grado di proteggerlo dalla corrosione.

Per completare la codifica dell'articolo è necessario sostituire i due trattini al termine del codice con il riferimento del rivestimento scegliendolo fra quelli presentati a fine collezione. L'esclusività di questi è data dall'irregolarità delle trame e sfumature che li caratterizzano, pertanto le immagini, ritraendone solo una parte, potrebbero non rispecchiare l'effetto finale sul prodotto.



Cromo lucido

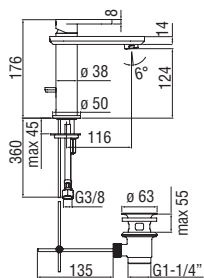

Inox spazzolato T.E.A.+®

**Monocomando**

- Limitatore di portata con freno al 50%
- Aeratore anticalcare M 24 x 1
- Scarico 1 1/4" con sistema brevettato SNAP
- Flessibili inox  $\varnothing$  3/8"

Cromo and Colour	DS106118/1C--	484,00 €
Cromo and Wood	DS106118/1C--	627,00 €
Inox T.E.A.+ and Fenix	DS106118/1T--	773,00 €
Cromo and Matter	DS106118/1C--	773,00 €
Cromo and Carbon	DS106118/1C--	1.210,00 €
Inox T.E.A.+ and Carbon	DS106118/1T--	1.210,00 €
Cromo and Guilloché	DS106118/1C--	1.449,00 €



CARTRIDGE  
WARRANTY



RCR280/D  
39,00 €

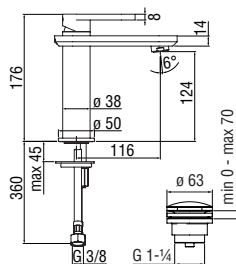

RAEK220/35CR  
29,00 € - 10 pz.

**Monocomando**

- Limitatore di portata con freno al 50%
- Aeratore anticalcare M 24 x 1
- Scarico 1 1/4" push
- Flessibili inox  $\varnothing$  3/8"

Cromo and Colour	DS106118/2C--	498,00 €
Cromo and Wood	DS106118/2C--	641,00 €
Inox T.E.A.+ and Fenix	DS106118/2T--	786,00 €
Cromo and Matter	DS106118/2C--	786,00 €
Cromo and Carbon	DS106118/2C--	1.224,00 €
Inox T.E.A.+ and Carbon	DS106118/2T--	1.224,00 €
Cromo and Guilloché	DS106118/2C--	1.462,00 €



CARTRIDGE  
WARRANTY



RCR280/D  
39,00 €

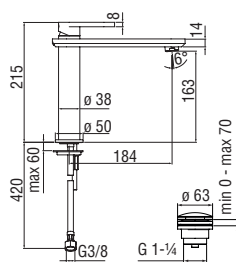

RAEK220/35CR  
29,00 € - 10 pz.

**Monocomando a bacinella**

- Limitatore di portata con freno al 50%
- Aeratore anticalcare M 24 x 1
- Scarico 1 1/4" push
- Flessibili inox  $\varnothing$  3/8"

Cromo and Colour	DS106158/2C--	578,00 €
Cromo and Wood	DS106158/2C--	746,00 €
Inox T.E.A.+ and Fenix	DS106158/2T--	917,00 €
Cromo and Matter	DS106158/2C--	917,00 €
Cromo and Carbon	DS106158/2C--	1.409,00 €
Inox T.E.A.+ and Carbon	DS106158/2T--	1.409,00 €
Cromo and Guilloché	DS106158/2C--	1.703,00 €



CARTRIDGE  
WARRANTY



RCR280/D  
39,00 €

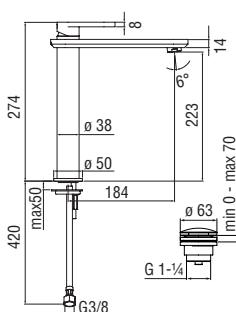

RAEK220/35CR  
29,00 € - 10 pz.

**Monocomando a bacinella**

- Limitatore di portata con freno al 50%
- Aeratore anticalcare M 24 x 1
- Scarico 1 1/4" push
- Flessibili inox  $\varnothing$  3/8"

Cromo and Colour	DS106128/2C--	665,00 €
Cromo and Wood	DS106128/2C--	833,00 €
Inox T.E.A.+ and Fenix	DS106128/2T--	1.001,00 €
Cromo and Matter	DS106128/2C--	1.001,00 €
Cromo and Carbon	DS106128/2C--	1.495,00 €
Inox T.E.A.+ and Carbon	DS106128/2T--	1.495,00 €
Cromo and Guilloché	DS106128/2C--	1.789,00 €



CARTRIDGE  
WARRANTY



RCR280/D  
39,00 €

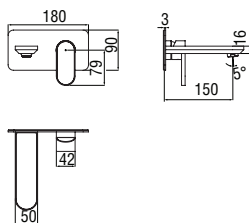

RAEK220/35CR  
29,00 € - 10 pz.

**Parte esterna monocomando a parete**

- Limitatore di portata con freno al 50%
- Aeratore anticalcare M 24 x 1
- Lunghezza bocca 150 mm
- Senza scarico

Cromo and Colour	DS106198C--	564,00 €
Cromo and Wood	DS106198C--	732,00 €
Inox T.E.A.+ and Fenix	DS106198T--	902,00 €
Cromo and Matter	DS106198C--	902,00 €
Cromo and Carbon	DS106198C--	1.396,00 €
Inox T.E.A.+ and Carbon	DS106198T--	1.396,00 €
Cromo and Guilloché	DS106198C--	1.689,00 €



RAEK220/35CR  
29,00 € - 10 pz.

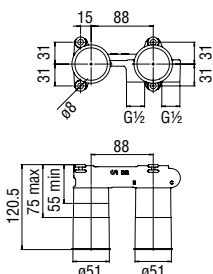

NR00212/10CR  
43,00 €

**Allbox, parte incasso necessaria**

- Ingresso acqua calda e acqua fredda  $\varnothing 1/2"$
- Uscita  $\varnothing 1/2"$

- WE00198 **MOD** 125,00 €



CARTRIDGE  
WARRANTY

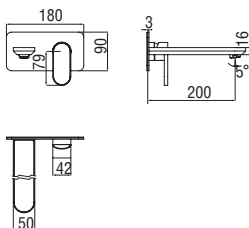

RCR350  
39,00 €

**Parte esterna monocomando a parete bocca lunga**

- Limitatore di portata con freno al 50%
- Aeratore anticalcare M 24 x 1
- Lunghezza bocca 200 mm
- Senza scarico

Cromo and Colour	DS106198/1C--	591,00 €
Cromo and Wood	DS106198/1C--	758,00 €
Inox T.E.A.+ and Fenix	DS106198/1T--	928,00 €
Cromo and Matter	DS106198/1C--	928,00 €
Cromo and Carbon	DS106198/1C--	1.423,00 €
Inox T.E.A.+ and Carbon	DS106198/1T--	1.423,00 €
Cromo and Guilloché	DS106198/1C--	1.716,00 €



RAEK220/35CR  
29,00 € - 10 pz.

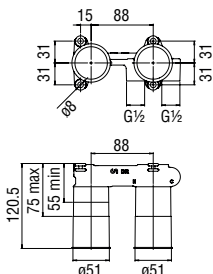

NR00212/10CR  
43,00 €

**Allbox, parte incasso necessaria**

- Ingresso acqua calda e acqua fredda  $\varnothing 1/2"$
- Uscita  $\varnothing 1/2"$

- WE00198 **MOD** 125,00 €



CARTRIDGE  
WARRANTY



RCR350  
39,00 €

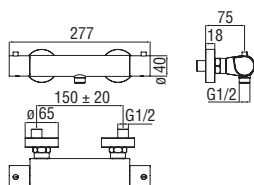

**Termostatico esterno**

- Blocco di sicurezza 38° C
- Valvoline antiritorno
- Uscita ø 1/2"
- Filtri di ricambio cartuccia inclusi nella confezione

Cromo and Colour	DS106030C--	415,00 €
Cromo and Wood	DS106030C--	538,00 €
Inox T.E.A.+ and Fenix	DS106030T--	664,00 €
Cromo and Matter	DS106030C--	664,00 €
Cromo and Carbon	DS106030C--	1.054,00 €
Inox T.E.A.+ and Carbon	DS106030T--	1.054,00 €
Cromo and Guilloché	DS106030C--	1.244,00 €



RCR201/5  
58,00 €

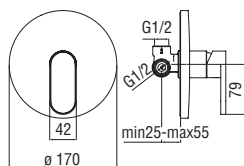

RVT200/26  
18,00 €

**Monocomando incasso a 1 via**

- Limitatore di portata con freno al 50%
- Tenuta o-ring invisibile
- Fissaggio a parete impermeabile
- Parte esterna e parte incasso

Cromo and Colour	DS106108C--	364,00 €
Cromo and Wood	DS106108C--	470,00 €
Inox T.E.A.+ and Fenix	DS106108T--	580,00 €
Cromo and Matter	DS106108C--	580,00 €
Cromo and Carbon	DS106108C--	935,00 €
Inox T.E.A.+ and Carbon	DS106108T--	935,00 €
Cromo and Guilloché	DS106108C--	1.088,00 €



CARTRIDGE  
WARRANTY



RCR350  
39,00 €

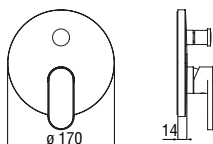

NR00212/10CR  
43,00 €

**Parte esterna monocomando incasso a 2 vie**

- Limitatore di portata con freno al 50%
- Deviatore con ritorno automatico
- Tenuta o-ring invisibile
- Fissaggio a parete impermeabile

Cromo and Colour	DS106100/EC--	295,00 €
Cromo and Wood	DS106100/EC--	403,00 €
Inox T.E.A.+ and Fenix	DS106100/ET--	512,00 €
Cromo and Matter	DS106100/EC--	512,00 €
Cromo and Carbon	DS106100/EC--	868,00 €
Inox T.E.A.+ and Carbon	DS106100/ET--	868,00 €
Cromo and Guilloché	DS106100/EC--	1.020,00 €

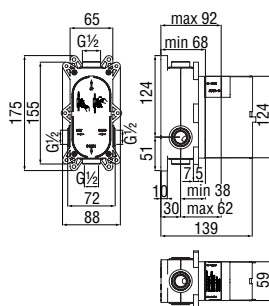

NR00212/13CR  
57,00 €

**Easybox 2 vie, parte incasso necessaria**

- Ingresso e uscita acqua ø 1/2"
- Adatta anche a montaggio su cartongesso

Nota: disponibile il dispositivo antireflusso RVRENI717 (opzionale)

WE81100 135,00 €



CARTRIDGE  
WARRANTY



RCR350  
39,00 €



RVRENI717  
33,00 €

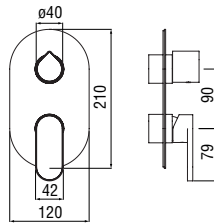

**Parte esterna monocomando incasso a 2-3 vie**

- Limitatore di portata con freno al 50%
- Tenuta o-ring invisibile
- Fissaggio a parete impermeabile

Cromo and Colour	WE81102/DSC--	589,00 €
Cromo and Wood	WE81102/DSC--	759,00 €
Inox T.E.A.+ and Fenix	WE81102/DST--	931,00 €
Cromo and Matter	WE81102/DSC--	931,00 €
Cromo and Carbon	WE81102/DSC--	1.429,00 €
Inox T.E.A.+ and Carbon	WE81102/DST--	1.429,00 €
Cromo and Guilloché	WE81102/DSC--	1.729,00 €

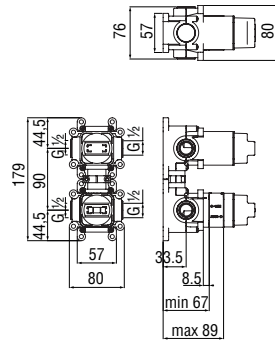
**Techbox 2 vie, parte incasso necessaria**

- Deviatore a 2 vie ceramico
- Ingresso e uscita acqua  $\varnothing$  1/2"
- Adatta anche a montaggio su cartongesso

- WE81102 160,00 €



CARTRIDGE  
WARRANTY



RCR350  
39,00 €



RCR201/35FSC  
39,00 €

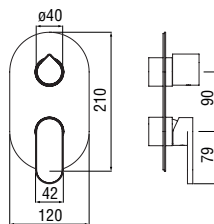

NR00212/30  
85,00 €

**Parte esterna monocomando incasso a 2-3 vie**

- Limitatore di portata con freno al 50%
- Tenuta o-ring invisibile
- Fissaggio a parete impermeabile

Cromo and Colour	WE81102/DSC--	589,00 €
Cromo and Wood	WE81102/DSC--	759,00 €
Inox T.E.A.+ and Fenix	WE81102/DST--	931,00 €
Cromo and Matter	WE81102/DSC--	931,00 €
Cromo and Carbon	WE81102/DSC--	1.429,00 €
Inox T.E.A.+ and Carbon	WE81102/DST--	1.429,00 €
Cromo and Guilloché	WE81102/DSC--	1.729,00 €

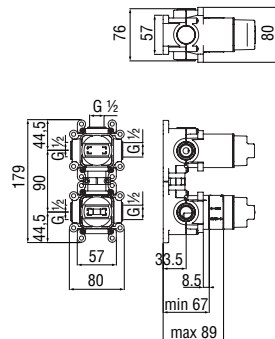
**Techbox 3 vie, parte incasso necessaria**

- Deviatore a 3 vie ceramico
- Ingresso e uscita acqua  $\varnothing$  1/2"
- Adatta anche a montaggio su cartongesso

- WE81103 184,00 €



CARTRIDGE  
WARRANTY



RCR350  
39,00 €



RCR201/35C  
39,00 €



NR00212/32  
85,00 €

**Parte esterna termostatico a 1 via**

- Blocco di sicurezza 38° C
- Montaggio verticale o orizzontale

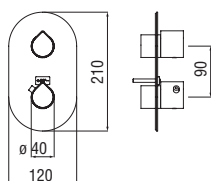

Cromo and Colour	DS106101C--	629,00 €
Cromo and Wood	DS106101C--	732,00 €
Inox T.E.A.+ and Fenix	DS106101T--	837,00 €
Cromo and Matter	DS106101C--	837,00 €
Cromo and Carbon	DS106101C--	1.180,00 €
Inox T.E.A.+ and Carbon	DS106101T--	1.180,00 €
Cromo and Guilloché	DS106101C--	1.323,00 €



NR00008  
34,00 €

**Wellbox 1 via, parte incasso necessaria**

- Ingresso e uscita acqua  $\varnothing$  1/2"
- Rubinetti di chiusura
- Valvole antiritorno
- Adatta anche a montaggio su cartongesso
- Filtri di ricambio cartuccia inclusi nella confezione

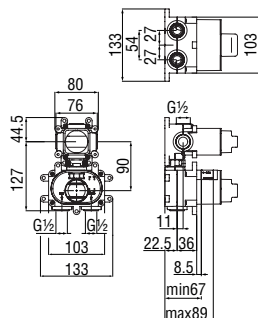

- WE00101 167,00 €



RCR201/5  
58,00 €



RVT200/5D  
18,00 €

**Parte esterna termostatico a 2 vie**

- Blocco di sicurezza 38° C
- Montaggio verticale o orizzontale

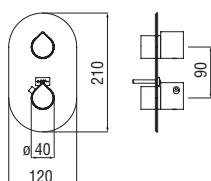

Cromo and Colour	DS106102C--	629,00 €
Cromo and Wood	DS106102C--	732,00 €
Inox T.E.A.+ and Fenix	DS106102T--	837,00 €
Cromo and Matter	DS106102C--	837,00 €
Cromo and Carbon	DS106102C--	1.180,00 €
Inox T.E.A.+ and Carbon	DS106102T--	1.180,00 €
Cromo and Guilloché	DS106102C--	1.323,00 €



NR00008  
34,00 €

**Wellbox 2 vie, parte incasso necessaria**

- Ingresso e uscita acqua  $\varnothing$  1/2"
- Rubinetti di chiusura
- Valvole antiritorno
- Adatta anche a montaggio su cartongesso
- Filtri di ricambio cartuccia inclusi nella confezione

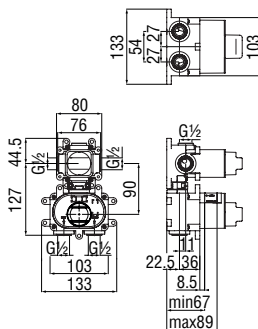

- WE00102 215,00 €



RCR201/5  
58,00 €



RCR201/28  
39,00 €

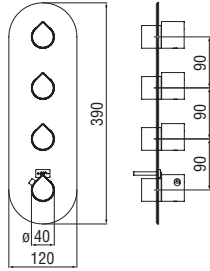

**Parte esterna termostatico a 3 vie**

- Blocco di sicurezza 38° C
- Montaggio verticale o orizzontale

Cromo and Colour	DS106103C--	993,00 €
Cromo and Wood	DS106103C--	1.240,00 €
Inox T.E.A.+ and Fenix	DS106103T--	1.490,00 €
Cromo and Matter	DS106103C--	1.490,00 €
Cromo and Carbon	DS106103C--	2.171,00 €
Inox T.E.A.+ and Carbon	DS106103T--	2.171,00 €
Cromo and Guilloché	DS106103C--	2.652,00 €

NR00008  
34,00 €

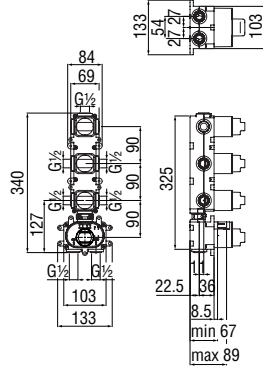

**Wellbox 3 vie, parte incasso necessaria**

- Ingresso e uscita acqua ø 1/2"
- Rubinetti di chiusura
- Valvole antiritorno
- Adatta anche a montaggio su cartongesso
- Filtri di ricambio cartuccia inclusi nella confezione

-	WE00103	318,00 €
---	---------	----------

RCR201/5  
58,00 €

RVT200/5D  
18,00 €

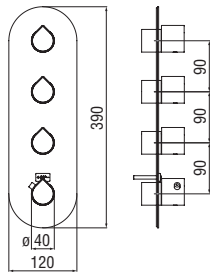

**Parte esterna termostatico a 4 vie**

- Blocco di sicurezza 38° C
- Montaggio verticale o orizzontale

Cromo and Colour	DS106104C--	993,00 €
Cromo and Wood	DS106104C--	1.240,00 €
Inox T.E.A.+ and Fenix	DS106104T--	1.490,00 €
Cromo and Matter	DS106104C--	1.490,00 €
Cromo and Carbon	DS106104C--	2.171,00 €
Inox T.E.A.+ and Carbon	DS106104T--	2.171,00 €
Cromo and Guilloché	DS106104C--	2.652,00 €

NR00008  
34,00 €

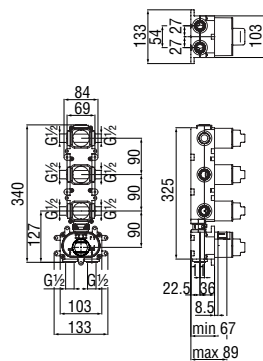

**Wellbox 4 vie, parte incasso necessaria**

- Ingresso e uscita acqua ø 1/2"
- Rubinetti di chiusura
- Valvole antiritorno
- Adatta anche a montaggio su cartongesso
- Filtri di ricambio cartuccia inclusi nella confezione

-	WE00104	360,00 €
---	---------	----------

RCR201/5  
58,00 €

RCR201/28  
39,00 €

RVT200/5D  
18,00 €

## COLOUR

Tinte raffinate e versatili valorizzate dal contrasto dei riflessi cromatici: le gradazioni dei laminati Colore permettono la realizzazione di uno spazio coerente ed al contempo sofisticato dove le sfumature si inseriscono con armonia in un soppesato susseguirsi di richiami fra le svariate componenti dell'arredo.



**01** CROMO AND MILKY WHITE

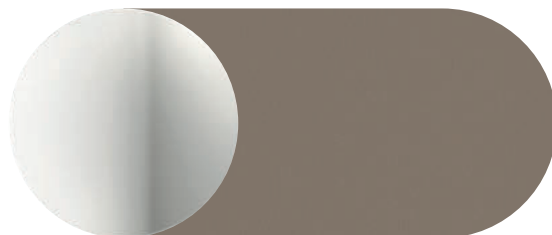

**07** CROMO AND SAHARA BROWN



**02** CROMO AND GOTHAM BLACK

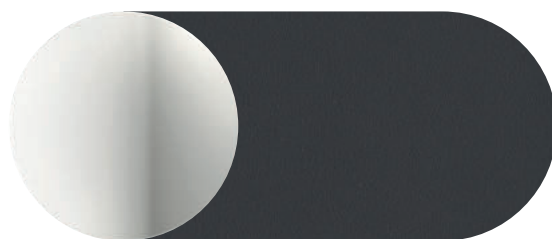

**08** CROMO AND VOLCANIC GRAY

## WOOD

Onde materiche in costante dialogo con le componenti d'arredo: quattro nuance di laminati Legno adatte a creare un'atmosfera calda e naturale senza rinunciare all'eleganza ed al minimalismo dei tratti. Contrasti intensi e bilanciati offrono la possibilità di dare luogo ad ambienti accoglienti ed intramontabili.



**09** CROMO AND SHABBY WOOD

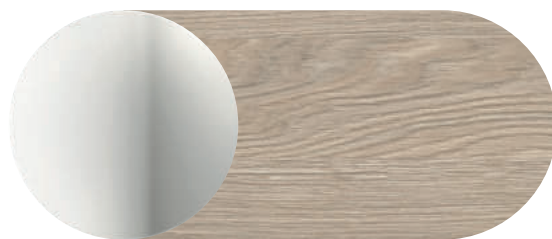

**11** CROMO AND HERITAGE WOOD



**10** CROMO AND VANILLA WOOD

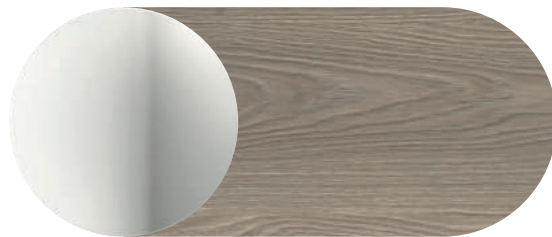

**12** CROMO AND TOBACCO WOOD

## FENIX®

Resine acriliche di ultima generazione per una superficie omogenea e dalle proprietà ineccepibili: antimpronta, opaca, soft touch.

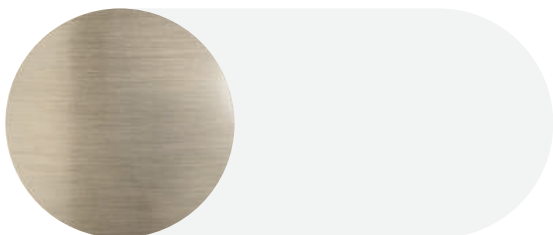

**BK** INOX T.E.A.+® AND FENIX NTM® BIANCO KOS

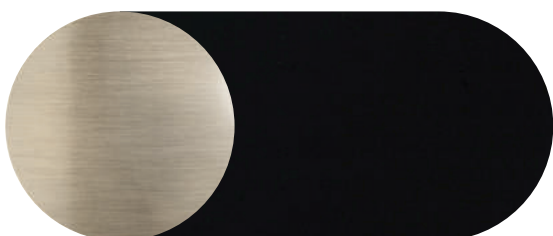

**NI** INOX T.E.A.+® AND FENIX NTM® NERO INGO

## CARBON

Il rivestimento più cool e giovanile: carbonio lucido oppure opaco, ideale per un ambiente dal look moderno e hi-tech.



**21** CROMO AND POLISHED CARBON

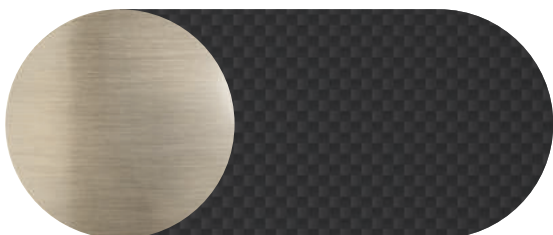

**22** INOX T.E.A.+® AND MATT CARBON

## MATTER

La ricercatezza tattile della pietra e del laminato corten, riflessi delle tendenze d'arredo sempre più vicine alla fisicità rurale.



**14** CROMO AND MIDNIGHT STONE

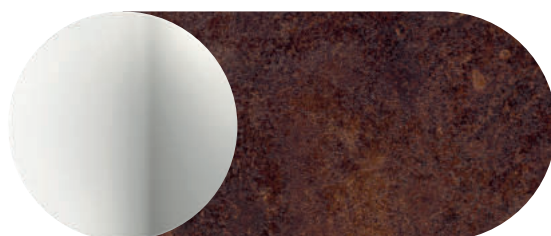

**16** CROMO AND CORTEN

## GUILLOCHÉ

Incantevoli, raffinate ed altamente esclusive lavorazioni artigianali, perfette per dare vita ad atmosfere signorili e ricercate.

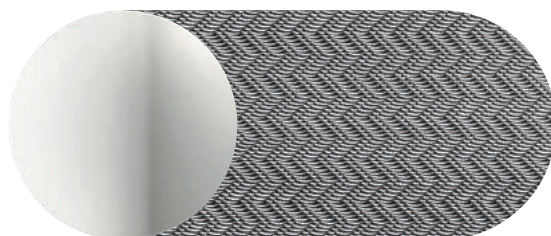

**17** CROMO AND CHEVRON GUILLOCHÉ

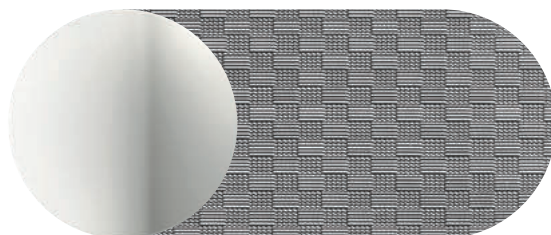

**19** CROMO AND SCOTTISH GUILLOCHÉ

RUBINETTERIA NOBILI

# LIKID

Rodolfo Dordoni, Gordon Guillaumier

Ridefinire i canoni dello stile: il design di Likid esprime passione e dinamismo. La tecnica, massima efficienza. La volontà di creare la migliore tecnologia per l'acqua impone di abbinare un design unico ed emozionale ad un progetto altamente innovativo, sviluppato per rendere indimenticabile ogni esperienza vissuta.

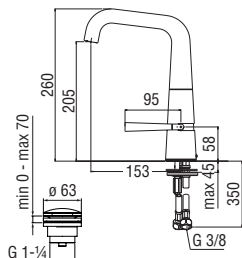

Cromo lucido

**Monocomando**

- Limitatore di energia con apertura in acqua fredda
- Aeratore anticalcare M 18,5 x 1, portata 5 l/min
- Bocca girevole
- Scarico 1 1/4" push
- Flessibili inox ø 3/8"

Cromo lucido

LK00118/2CR

478,00 €

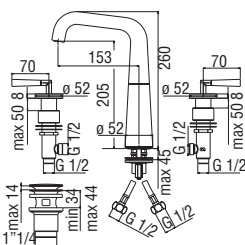
RCR2020  
41,00 €RAEK222/44  
61,00 € - 10 pz.**Batteria 3 fori**

- Aeratore anticalcare M 18,5 x 1, portata 5 l/min
- Bocca girevole
- Scarico 1 1/4" push
- Flessibili inox ø 3/8"

Cromo lucido

LK00211/2CR

620,00 €

RVT200/5S  
18,00 €RVT200/5D  
18,00 €RAEK222/44  
61,00 € - 10 pz.

## BIDET

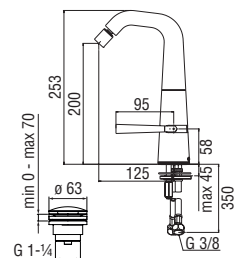
**Monocomando**

- Limitatore di energia con apertura in acqua fredda
- Aeratore anticalcare M 18,5 x 1, portata 5 l/min
- Bocca girevole
- Getto orientabile
- Scarico 1 1/4" push
- Flessibili inox ø 3/8"

Cromo lucido

LK00119/2CR

488,00 €

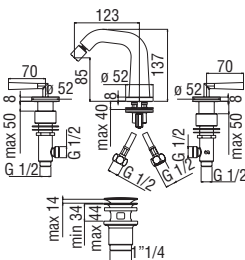
RCR2020  
41,00 €RAE222/44CR  
22,00 € - 10 pz.**Batteria 3 fori**

- Aeratore anticalcare M 18,5 x 1, portata 5 l/min
- Getto orientabile
- Scarico 1 1/4" push
- Flessibili inox ø 3/8"

Cromo lucido

LK00215/2CR

602,00 €

RVT200/5D  
18,00 €RVT200/5S  
18,00 €RAEK222/44CR  
22,00 € - 10 pz.



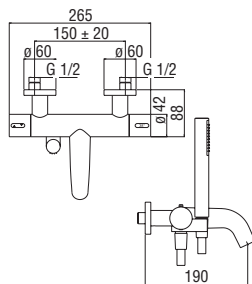

**Termostatico esterno con set doccia**

- Blocco di sicurezza 38° C
- Valvoline antiritorno
- Aeratore anticalcare M 24 x 1
- Supporto doccetta fisso
- Doccetta monogetto e flessibile 150 cm

Cromo lucido LK00010/2CR 755,00 €



RCR201/56  
58,00 €



RCR201/57  
51,00 €



RAEK222/22  
45,00 € - 10 pz.

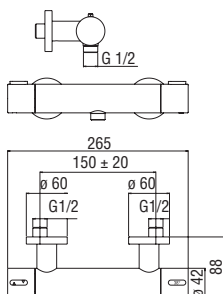

**Termostatico esterno**

- Blocco di sicurezza 38° C
- Valvoline antiritorno
- Uscita Ø 1/2"

Cromo lucido LK00030CR 531,00 €



RCR201/56  
58,00 €



RVT200/28  
21,00 €

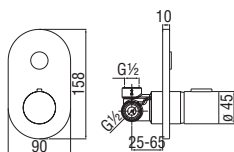

**Monocomando incasso a 1 via**

- Ingresso acqua calda e acqua fredda Ø 1/2"
- Uscita Ø 1/2"
- Parte esterna e parte incasso

Cromo lucido LK00108CR 210,00 €



RCR450  
39,00 €



NR00212/5CR  
51,00 €

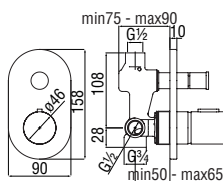

**Monocomando incasso a 2 vie**

- Ingresso acqua calda e acqua fredda Ø 1/2"
- Uscite Ø 1/2"
- Deviatore con ritorno automatico
- Parte esterna e parte incasso

Cromo lucido LK00100CR 355,00 €



RCR450  
39,00 €



NR00212/12CR  
63,00 €

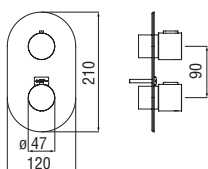

**Parte esterna termostatico a 1 via**

- Blocco di sicurezza 38° C
- Montaggio verticale o orizzontale

Cromo lucido LK00101CR 417,00 €



NR00008  
34,00 €

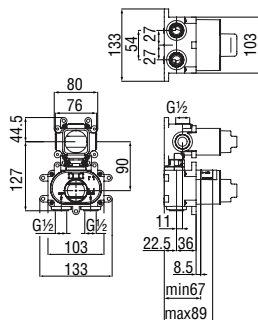

**Wellbox 1 via, parte incasso necessaria**

- Ingresso e uscita acqua  $\varnothing$  1/2"
- Rubinetti di chiusura
- Valvole antiritorno
- Adatta anche a montaggio su cartongesso
- Filtri di ricambio cartuccia inclusi nella confezione

- WE00101 167,00 €



RCR201/5  
58,00 €



RVT200/5D  
18,00 €

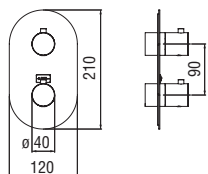

**Parte esterna termostatico a 2 vie**

- Blocco di sicurezza 38° C
- Montaggio verticale o orizzontale

Cromo lucido LK00102CR 417,00 €



NR00008  
34,00 €

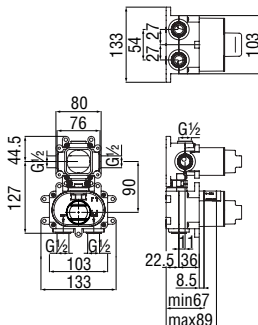

**Wellbox 2 vie, parte incasso necessaria**

- Ingresso e uscita acqua  $\varnothing$  1/2"
- Rubinetti di chiusura
- Valvole antiritorno
- Adatta anche a montaggio su cartongesso
- Filtri di ricambio cartuccia inclusi nella confezione

- WE00102 215,00 €



RCR201/5  
58,00 €



RCR201/28  
39,00 €

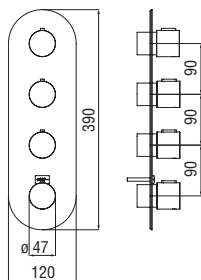

**Parte esterna termostatico a 3 vie**

- Blocco di sicurezza 38° C
- Montaggio verticale o orizzontale

Cromo lucido LK00103CR 845,00 €

 NR00008  
34,00 €

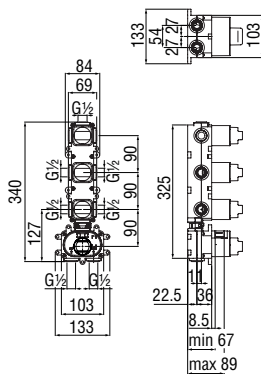

**Wellbox 3 vie, parte incasso necessaria**

- Ingresso e uscita acqua  $\varnothing$  1/2"
- Rubinetti di chiusura
- Valvole antiritorno
- Adatta anche a montaggio su cartongesso
- Filtri di ricambio cartuccia inclusi nella confezione

- WE00103 318,00 €

 RCR201/5  
58,00 €

 RVT200/5D  
18,00 €

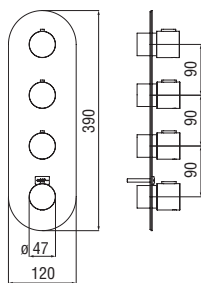

**Parte esterna termostatico a 4 vie**

- Blocco di sicurezza 38° C
- Montaggio verticale o orizzontale

Cromo lucido LK00104CR 845,00 €

 NR00008  
34,00 €

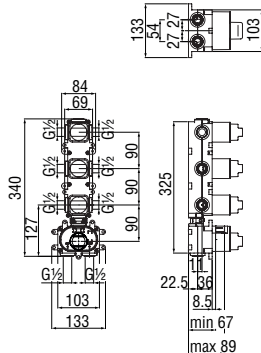

**Wellbox 4 vie, parte incasso necessaria**

- Ingresso e uscita acqua  $\varnothing$  1/2"
- Rubinetti di chiusura
- Valvole antiritorno
- Adatta anche a montaggio su cartongesso
- Filtri di ricambio cartuccia inclusi nella confezione

- WE00104 360,00 €

 RCR201/5  
58,00 €

 RCR201/28  
39,00 €

 RVT200/5D  
18,00 €



RUBINETTERIA NOBILI

# LIVE

Centro Stile Nobili

Stile equilibrato ed elegante, libero da eccessi stilistici. Il design pulito ed essenziale di Live supera le mode e riflette l'anima del design intramontabile. L'impareggiabile ecosostenibilità della cartuccia Nobili Widd® da 28 millimetri ne completa l'armonia e testimonia lo stretto legame del nostro brand tra efficienza tecnologica e rispetto ambientale.



Cromo lucido



Inox spazzolato



Grafite spazzolato PVD



Mora opaco



Neve opaco



Miele spazzolato PVD

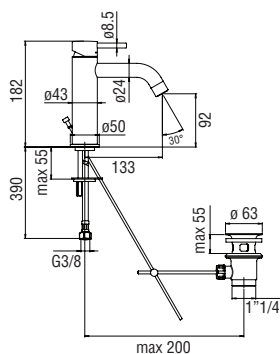

Argilla spazzolato PVD

**Monocomando**

- Limitatore di portata con freno al 50%
- Aeratore anticalcare M 22 x 1, portata 5 l/min
- Scarico 1 1/4" con sistema brevettato SNAP
- Flessibili inox ø 3/8"

Cromo lucido	LV00118/15CR	245,00 €
Inox spazzolato	LV00118/15IX	368,00 €
Grafite spazzolato PVD	LV00118/15GUP	<b>NEW</b> 392,00 €
Mora opaco	LV00118/15BM	368,00 €
Neve opaco	LV00118/15WM	368,00 €
Miele spazzolato PVD	LV00118/15CGP	<b>NEW</b> 392,00 €
Argilla spazzolato PVD	LV00118/15RTP	<b>NEW</b> 392,00 €



CARTRIDGE  
WARRANTY



RCR280/D  
39,00 €

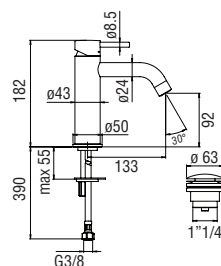

RAEK219/67CR  
75,00 € - 10 pz.

**Monocomando**

- Limitatore di portata con freno al 50%
- Aeratore anticalcare M 22 x 1, portata 5 l/min
- Scarico 1 1/4" push
- Flessibili inox ø 3/8"

Cromo lucido	LV00118/16CR	258,00 €
Inox spazzolato	LV00118/16IX	387,00 €
Grafite spazzolato PVD	LV00118/16GUP	<b>NEW</b> 413,00 €
Mora opaco	LV00118/16BM	387,00 €
Neve opaco	LV00118/16WM	387,00 €
Miele spazzolato PVD	LV00118/16CGP	<b>NEW</b> 413,00 €
Argilla spazzolato PVD	LV00118/16RTP	<b>NEW</b> 413,00 €



CARTRIDGE  
WARRANTY



RCR280/D  
39,00 €

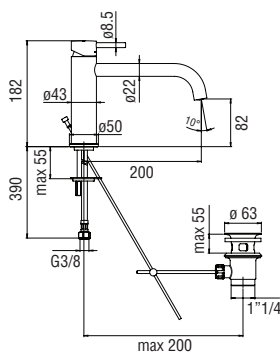

RAEK219/67CR  
75,00 € - 10 pz.

**Monocomando bocca lunga**

- Limitatore di portata con freno al 50%
- Aeratore anticalcare M 18,5 x 1, portata 5 l/min
- Scarico 1 1/4" con sistema brevettato SNAP
- Flessibili inox ø 3/8"

Cromo lucido	LV00118/5CR	264,00 €
Inox spazzolato	LV00118/5IX	396,00 €



CARTRIDGE  
WARRANTY



RCR280/D  
39,00 €

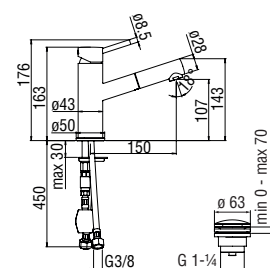

RAEK222/44  
61,00 € - 10 pz.

**Monocomando con doccetta estraibile**

- Limitatore di portata con freno al 50%
- Doccetta monogetto estraibile
- Scarico 1 1/4" push
- Flessibili inox ø 3/8"

Cromo lucido	LV00118/40CR	271,00 €
Inox spazzolato	LV00118/40IX	406,00 €
Grafite spazzolato PVD	LV00118/40GUP	<b>NEW</b> 434,00 €
Mora opaco	LV00118/40BM	406,00 €
Neve opaco	LV00118/40WM	406,00 €
Miele spazzolato PVD	LV00118/40CGP	<b>NEW</b> 434,00 €
Argilla spazzolato PVD	LV00118/40RTP	<b>NEW</b> 434,00 €



CARTRIDGE  
WARRANTY

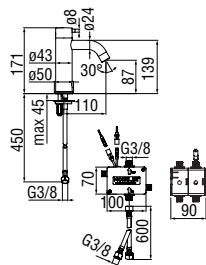

RCR350  
39,00 €

**Comando infrarossi**

- Aeratore anticalcare M 22 x 1
- Alimentazione a batteria
- Senza scarico
- Flessibili inox  $\varnothing$  3/8"

Cromo lucido IRLV00118/3CR 455,00 €

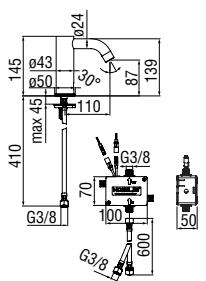

RAEK219/67CR  
75,00 € - 10 pz.

**Comando infrarossi monoacqua**

- Aeratore anticalcare M 22 x 1
- Alimentazione a batteria
- Senza scarico
- Flessibili inox  $\varnothing$  3/8"

Cromo lucido IRLV00236CR 400,00 €

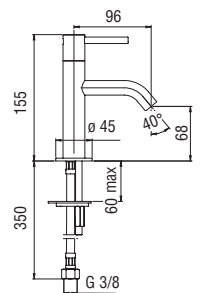

RAEK219/67CR  
75,00 € - 10 pz.

**Rubinetto monoacqua**

- Aeratore anticalcare M 16,5 x 1, portata 5 l/min
- Senza scarico
- Flessibile inox  $\varnothing$  3/8"

Cromo lucido	LVO0236CR	171,00 €
Inox spazzolato	LVO0236IX	258,00 €
Grafite spazzolato PVD	LVO0236GUP	<b>NEW</b> 274,00 €
Mora opaco	LVO0236BM	258,00 €
Neve opaco	LVO0236WM	258,00 €
Miele spazzolato PVD	LVO0236CGP	<b>NEW</b> 274,00 €
Argilla spazzolato PVD	LVO0236RTP	<b>NEW</b> 274,00 €



RVT200/5D  
18,00 €

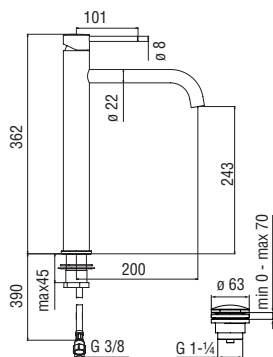

RAEK219/28  
58,00 € - 10 pz.

**Monocomando a bacinella**

- Limitatore di portata con freno al 50%
- Aeratore anticalcare M 18,5 x 1, portata 5 l/min
- Scarico 1 1/4" push
- Flessibili inox  $\varnothing$  3/8"

Cromo lucido	LVO0128/2CR	289,00 €
Inox spazzolato	LVO0128/2IX	434,00 €
Grafite spazzolato PVD	LVO0128/2GUP	<b>NEW</b> 462,00 €
Mora opaco	LVO0128/2BM	434,00 €
Neve opaco	LVO0128/2WM	434,00 €
Miele spazzolato PVD	LVO0128/2CGP	<b>NEW</b> 462,00 €
Argilla spazzolato PVD	LVO0128/2RTP	<b>NEW</b> 462,00 €



20 YEARS  
CARTRIDGE  
WARRANTY



RCR350  
39,00 €



RAEK222/44  
61,00 € - 10 pz.

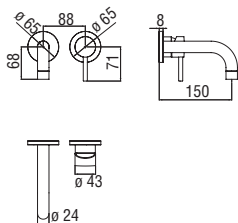

**Parte esterna monocomando a parete**

- Limitatore di portata con freno al 50%
- Aeratore anticalcare M 22 x 1, portata 5 l/min
- Lunghezza bocca 150 mm
- Senza scarico

Cromo lucido	LV00199CR	236,00 €
Inox spazzolato	LV00199IX	353,00 €
Grafite spazzolato PVD	LV00199GUP	<b>NEW</b> 378,00 €
Mora opaco	LV00199BM	353,00 €
Neve opaco	LV00199WM	353,00 €
Miele spazzolato PVD	LV00199CGP	<b>NEW</b> 378,00 €
Argilla spazzolato PVD	LV00199RTP	<b>NEW</b> 378,00 €



RAEK219/67CR  
75,00 € - 10 pz.

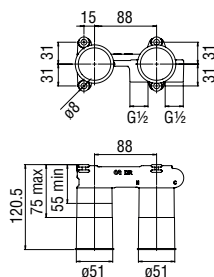

NR00212/10CR  
43,00 €

**Allbox, parte incasso necessaria**

- Ingresso acqua calda e acqua fredda ø 1/2"
- Uscita ø 1/2"

- WE00198 **MOD** 125,00 €



CARTRIDGE  
WARRANTY

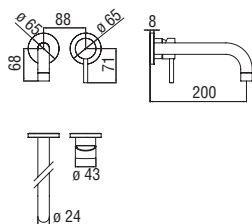

RCR350  
39,00 €

**Parte esterna monocomando a parete bocca lunga**

- Limitatore di portata con freno al 50%
- Aeratore anticalcare M 22 x 1, portata 5 l/min
- Lunghezza bocca 200 mm
- Senza scarico

Cromo lucido	LV00199/1CR	265,00 €
Inox spazzolato	LV00199/1IX	397,00 €
Grafite spazzolato PVD	LV00199/1GUP	<b>NEW</b> 424,00 €
Mora opaco	LV00199/1BM	397,00 €
Neve opaco	LV00199/1WM	397,00 €
Miele spazzolato PVD	LV00199/1CGP	<b>NEW</b> 424,00 €
Argilla spazzolato PVD	LV00199/1RTP	<b>NEW</b> 424,00 €



RAEK219/67CR  
75,00 € - 10 pz.

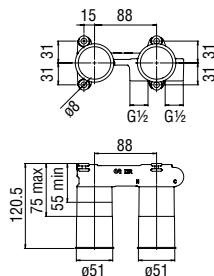

NR00212/10CR  
43,00 €

**Allbox, parte incasso necessaria**

- Ingresso acqua calda e acqua fredda ø 1/2"
- Uscita ø 1/2"

- WE00198 **MOD** 125,00 €



CARTRIDGE  
WARRANTY

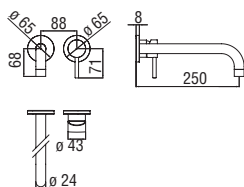

RCR350  
39,00 €

**Parte esterna monocomando a parete bocca lunga**

- Limitatore di portata con freno al 50%
- Aeratore anticalcare M 22 x 1, portata 5 l/min
- Lunghezza bocca 250 mm
- Senza scarico

Cromo lucido	LVO0199/2CR	294,00 €
Inox spazzolato	LVO0199/2IX	442,00 €
Grafite spazzolato PVD	LVO0199/2GUP	<b>NEW</b> 470,00 €
Mora opaco	LVO0199/2BM	442,00 €
Neve opaco	LVO0199/2WM	442,00 €
Miele spazzolato PVD	LVO0199/2CGP	<b>NEW</b> 470,00 €
Argilla spazzolato PVD	LVO0199/2RTP	<b>NEW</b> 470,00 €



RAEK219/67CR  
75,00 € - 10 pz.

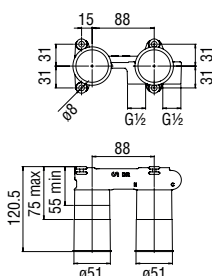

NR00212/10CR  
43,00 €

**Allbox, parte incasso necessaria**

- Ingresso acqua calda e acqua fredda ø 1/2"
- Uscita ø 1/2"

- WE00198 **MOD** 125,00 €



CARTRIDGE  
WARRANTY

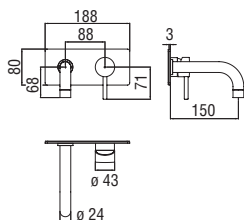

RCR350  
39,00 €

**Parte esterna monocomando a parete**

- Limitatore di portata con freno al 50%
- Aeratore anticalcare M 22 x 1, portata 5 l/min
- Lunghezza bocca 150 mm
- Senza scarico

Cromo lucido	LVO0198CR	269,00 €
Inox spazzolato	LVO0198IX	403,00 €
Grafite spazzolato PVD	LVO0198GUP	<b>NEW</b> 430,00 €
Mora opaco	LVO0198BM	403,00 €
Neve opaco	LVO0198WM	403,00 €
Miele spazzolato PVD	LVO0198CGP	<b>NEW</b> 430,00 €
Argilla spazzolato PVD	LVO0198RTP	<b>NEW</b> 430,00 €



RAEK219/67CR  
75,00 € - 10 pz.

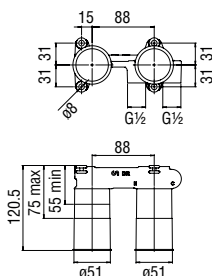

NR00212/10CR  
43,00 €

**Allbox, parte incasso necessaria**

- Ingresso acqua calda e acqua fredda ø 1/2"
- Uscita ø 1/2"

- WE00198 **MOD** 125,00 €



CARTRIDGE  
WARRANTY



RCR350  
39,00 €

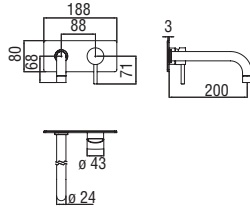

**Parte esterna monocomando a parete bocca lunga**

- Limitatore di portata con freno al 50%
- Aeratore anticalcare M 22 x 1, portata 5 l/min
- Lunghezza bocca 200 mm
- Senza scarico

Cromo lucido	LV00198/1CR	299,00 €
Inox spazzolato	LV00198/1IX	447,00 €
Grafite spazzolato PVD	LV00198/1GUP	<b>NEW</b> 478,00 €
Mora opaco	LV00198/1BM	447,00 €
Neve opaco	LV00198/1WM	447,00 €
Miele spazzolato PVD	LV00198/1CGP	<b>NEW</b> 478,00 €
Argilla spazzolato PVD	LV00198/1RTP	<b>NEW</b> 478,00 €

RAEK219/67CR 75,00 € - 10 pz.  
 NR00212/10CR 43,00 €

**Allbox, parte incasso necessaria**

- Ingresso acqua calda e acqua fredda ø 1/2"
- Uscita ø 1/2"

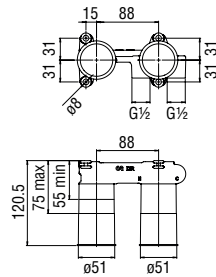

- WE00198 **MOD** 125,00 €

20 YEARS WARRANTY  
 RCR350 39,00 €

**Parte esterna monocomando a parete bocca lunga**

- Limitatore di portata con freno al 50%
- Aeratore anticalcare M 22 x 1, portata 5 l/min
- Lunghezza bocca 250 mm
- Senza scarico

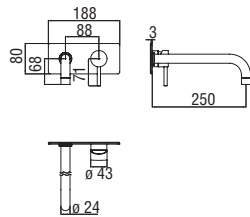

Cromo lucido	LV00198/2CR	328,00 €
Inox spazzolato	LV00198/2IX	491,00 €
Grafite spazzolato PVD	LV00198/2GUP	<b>NEW</b> 525,00 €
Mora opaco	LV00198/2BM	491,00 €
Neve opaco	LV00198/2WM	491,00 €
Miele spazzolato PVD	LV00198/2CGP	<b>NEW</b> 525,00 €
Argilla spazzolato PVD	LV00198/2RTP	<b>NEW</b> 525,00 €

RAEK219/67CR 75,00 € - 10 pz.  
 NR00212/10CR 43,00 €

**Allbox, parte incasso necessaria**

- Ingresso acqua calda e acqua fredda ø 1/2"
- Uscita ø 1/2"

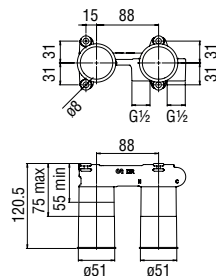

- WE00198 **MOD** 125,00 €

20 YEARS WARRANTY  
 RCR350 39,00 €

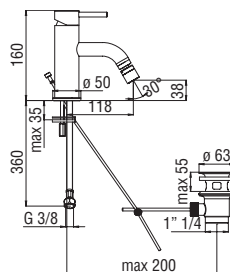

**Monocomando**

- Limitatore di portata con freno al 50%
- Aeratore anticalcare M 22 x 1, getto orientabile
- Scarico 1 1/4" con sistema brevettato SNAP
- Flessibili inox  $\varnothing$  3/8"

Cromo lucido	LVO0119/1CR	245,00 €
Inox spazzolato	LVO0119/1IX	368,00 €
Grafite spazzolato PVD	LVO0119/1GUP	<b>NEW</b> 392,00 €
Mora opaco	LVO0119/1BM	368,00 €
Neve opaco	LVO0119/1WM	368,00 €
Miele spazzolato PVD	LVO0119/1CGP	<b>NEW</b> 392,00 €
Argilla spazzolato PVD	LVO0119/1RTP	<b>NEW</b> 392,00 €



CARTRIDGE WARRANTY



RCR350 39,00 €



RAE219/82CR 25,00 € - 1 pz.

VASCA A PAVIMENTO

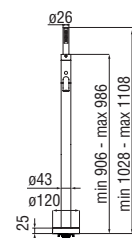
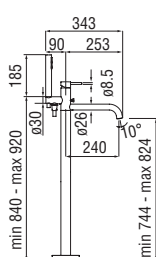

**Parte esterna monocomando a 2 vie**

- Limitatore di portata con freno al 50%
- Aeratore anticalcare M 24 x 1
- Deviatore con ritorno automatico
- Supporto doccetta fisso
- Doccetta monogetto e flessibile 150 cm

Cromo lucido	WE00180/TCR	<b>MOD</b>	1.373,00 €
Inox spazzolato	WE00180/TIX	<b>MOD</b>	2.062,00 €
Grafite spazzolato PVD	WE00180/TGUP	<b>NEW</b>	2.197,00 €
Mora opaco	WE00180/TBM	<b>MOD</b>	2.062,00 €
Neve opaco	WE00180/TWM	<b>MOD</b>	2.062,00 €
Miele spazzolato PVD	WE00180/TCGP	<b>NEW</b>	2.197,00 €
Argilla spazzolato PVD	WE00180/TRTP	<b>NEW</b>	2.197,00 €



CARTRIDGE WARRANTY



RCR350 39,00 €



RAEK222/22 45,00 € - 10 pz.

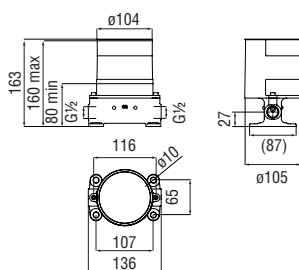

**Parte incasso necessaria**

- Ingresso acqua calda e acqua fredda  $\varnothing$  1/2"

-	WE77250	<b>MOD</b>	291,00 €
---	---------	------------	----------

BORDO VASCA

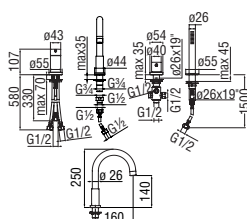

**Monocomando bordo vasca**

- Limitatore di portata con freno al 50%
- Aeratore anticalcare M 24 x 1
- Deviatore a 2 vie
- Doccetta monogetto estraibile

Cromo lucido	WEBK110/9TCR	734,00 €
Inox spazzolato	WEBK110/9TIX	1.089,00 €
Grafite spazzolato PVD	WEBK110/9TGUP	<b>NEW</b> 1.174,00 €
Mora opaco	WEBK110/9TBM	1.089,00 €
Neve opaco	WEBK110/9TWM	1.089,00 €
Miele spazzolato PVD	WEBK110/9TCGP	<b>NEW</b> 1.174,00 €
Argilla spazzolato PVD	WEBK110/9RTP	<b>NEW</b> 1.174,00 €



CARTRIDGE WARRANTY



RCR350 39,00 €



RAEK219/43CR 38,00 € - 5 pz.



### Termostatico esterno

- Blocco di sicurezza 38° C
- Valvoline antiritorno
- Aeratore anticalcare M 24 x 1
- Uscita ø 1/2"

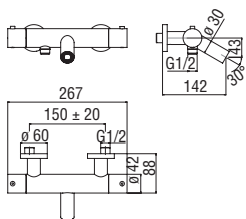

Cromo lucido	LVO0010/1CR	611,00 €
Inox spazzolato	LVO0010/1IX	918,00 €
Grafite spazzolato PVD	LVO0010/1GUP	<b>NEW</b> 978,00 €
Mora opaco	LVO0010/1BM	918,00 €
Neve opaco	LVO0010/1WM	918,00 €
Miele spazzolato PVD	LVO0010/1CGP	<b>NEW</b> 978,00 €
Argilla spazzolato PVD	LVO0010/1RTP	<b>NEW</b> 978,00 €



RCR201/56  
58,00 €



RCR201/57  
51,00 €



RAEK222/22  
45,00 € - 10 pz.

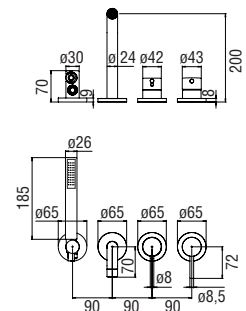

### Parte esterna monocomando incasso a 2 vie

- Limitatore di portata con freno al 50%
- Deviatore a 2 vie
- Aeratore anticalcare M 22 x 1
- Doccetta monogetto e flessibile 150 cm

Cromo lucido	WEBK110/91TCR	524,00 €
Inox spazzolato	WEBK110/91TIX	784,00 €
Grafite spazzolato PVD	WEBK110/91TGUP	<b>NEW</b> 838,00 €
Mora opaco	WEBK110/91TBM	784,00 €
Neve opaco	WEBK110/91TWM	784,00 €
Miele spazzolato PVD	WEBK110/91TCGP	<b>NEW</b> 838,00 €
Argilla spazzolato PVD	WEBK110/91TRTP	<b>NEW</b> 838,00 €



RAEK220/36CR  
53,00 € - 10 pz.



NR00212/22CR  
85,00 €

### Parte incasso necessaria

- Ingresso e uscita acqua ø 1/2"

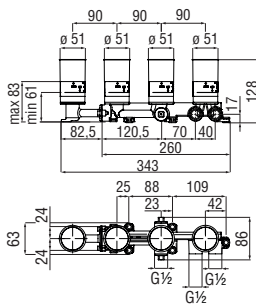

-	WE81201/T	<b>NEW</b>	390,00 €
---	-----------	------------	----------



CARTRIDGE  
WARRANTY



RCR350  
39,00 €



RCR201/35FSC  
39,00 €

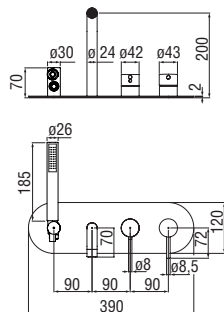

**Parte esterna monocomando incasso a 2 vie**

- Limitatore di portata con freno al 50%
- Deviatore a 2 vie
- Aeratore anticalcare M 22 x 1
- Doccetta monogetto e flessibile 150 cm

Cromo lucido	WEBK110/90TCR	524,00 €
Inox spazzolato	WEBK110/90TIX	784,00 €
Grafite spazzolato PVD	WEBK110/90TGUP	<b>NEW</b> 838,00 €
Mora opaco	WEBK110/90TBM	784,00 €
Neve opaco	WEBK110/90TWM	784,00 €
Miele spazzolato PVD	WEBK110/90TCGP	<b>NEW</b> 838,00 €
Argilla spazzolato PVD	WEBK110/90TRTP	<b>NEW</b> 838,00 €

 RAEK220/36CR 53,00 € - 10 pz.  
 NR00212/22CR 85,00 €

**Parte incasso necessaria**

- Ingresso e uscita acqua ø 1/2"

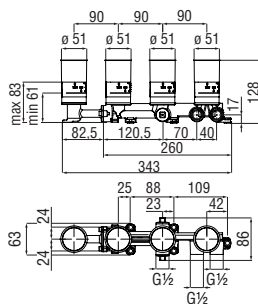

-	WE81201/T	<b>NEW</b> 390,00 €
---	-----------	---------------------

 CARTRIDGE WARRANTY  
 RCR350 39,00 €  
 RCR201/35FSC 39,00 €

**Bocca a parete**

- Aeratore anticalcare M 22 x 1
- Lunghezza 200 mm

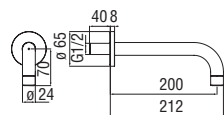

Cromo lucido	AV00158/36CR	103,00 €
Inox spazzolato	AV00158/36IX	155,00 €
Grafite spazzolato PVD	AV00158/36GUP	164,00 €
Mora opaco	AV00158/36BM	155,00 €
Neve opaco	AV00158/36WM	155,00 €
Miele spazzolato PVD	AV00158/36CGP	<b>NEW</b> 164,00 €
Argilla spazzolato PVD	AV00158/36RTP	164,00 €

 RAEK220/36CR 53,00 € - 10 pz.

DOCCIA

**Monocomando esterno**

- Limitatore di portata con freno al 50%
- Uscita ø 1/2"

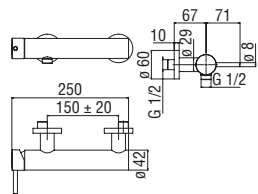

Cromo lucido	LV00130CR	264,00 €
Inox spazzolato	LV00130IX	396,00 €
Grafite spazzolato PVD	LV00130GUP	<b>NEW</b> 422,00 €
Mora opaco	LV00130BM	396,00 €
Neve opaco	LV00130WM	396,00 €
Miele spazzolato PVD	LV00130CGP	<b>NEW</b> 422,00 €
Argilla spazzolato PVD	LV00130RTP	<b>NEW</b> 422,00 €

 CARTRIDGE WARRANTY  
 RCR350 39,00 €

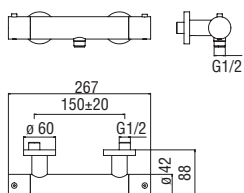

**Termostatico esterno**

- Blocco di sicurezza 38° C
- Valvoline antiritorno
- Uscita ø 1/2"

Cromo lucido	LVO0030CR	487,00 €
Inox spazzolato	LVO0030IX	732,00 €
Grafite spazzolato PVD	LVO0030GUP	<b>NEW</b> 779,00 €
Mora opaco	LVO0030BM	732,00 €
Neve opaco	LVO0030WM	732,00 €
Miele spazzolato PVD	LVO0030CGP	<b>NEW</b> 779,00 €
Argilla spazzolato PVD	LVO0030RTP	<b>NEW</b> 779,00 €



RCR201/56  
58,00 €

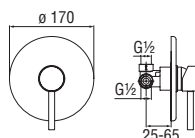

RVT200/28  
21,00 €

**Monocomando incasso a 1 via**

- Limitatore di portata con freno al 50%
- Tenuta o-ring invisibile, fissaggio a parete impermeabile
- Ingresso e uscita acqua ø 1/2"
- Parte esterna e parte incasso

Cromo lucido	LVO0108CR	166,00 €
Inox spazzolato	LVO0108IX	249,00 €
Grafite spazzolato PVD	LVO0108GUP	<b>NEW</b> 266,00 €
Mora opaco	LVO0108BM	249,00 €
Neve opaco	LVO0108WM	249,00 €
Miele spazzolato PVD	LVO0108CGP	<b>NEW</b> 266,00 €
Argilla spazzolato PVD	LVO0108RTP	<b>NEW</b> 266,00 €



CARTRIDGE  
WARRANTY



RCR350  
39,00 €

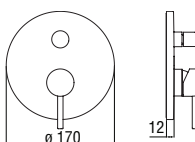

NR00212/10CR  
43,00 €

**Parte esterna monocomando incasso a 2 vie**

- Limitatore di portata con freno al 50%
- Deviatore con ritorno automatico
- Tenuta o-ring invisibile, fissaggio a parete impermeabile

Cromo lucido	LVO0100/ECR	230,00 €
Inox spazzolato	LVO0100/EIX	347,00 €
Grafite spazzolato PVD	LVO0100/EGUP	<b>NEW</b> 368,00 €
Mora opaco	LVO0100/EBM	347,00 €
Neve opaco	LVO0100/EWM	347,00 €
Miele spazzolato PVD	LVO0100/ECGP	<b>NEW</b> 368,00 €
Argilla spazzolato PVD	LVO0100/ERTP	<b>NEW</b> 368,00 €

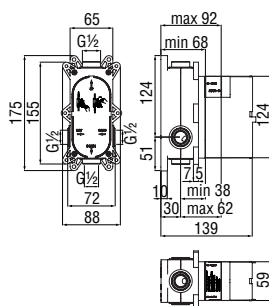

NR00212/13CR  
57,00 €

**Easybox 2 vie, parte incasso necessaria**

- Ingresso e uscita acqua ø 1/2"
- Adatta anche a montaggio su cartongesso

Nota: disponibile il dispositivo antireflusso RVREN1717 (opzionale)

-	WE81100	135,00 €
---	---------	----------



CARTRIDGE  
WARRANTY



RCR350  
39,00 €



RVREN1717  
33,00 €

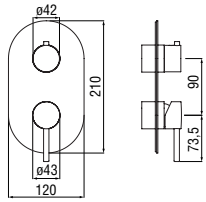

### Parte esterna monocomando incasso a 2-3 vie

- Limitatore di portata con freno al 50%
- Tenuta o-ring invisibile, fissaggio a parete impermeabile

Cromo lucido	WE81102/TCR	413,00 €
Inox spazzolato	WE81102/TIX	618,00 €
Grafite spazzolato PVD	WE81102/TGUP	<b>NEW</b> 661,00 €
Mora opaco	WE81102/TBM	618,00 €
Neve opaco	WE81102/TWM	618,00 €
Miele spazzolato PVD	WE81102/TCGP	<b>NEW</b> 661,00 €
Argilla spazzolato PVD	WE81102/TRTP	<b>NEW</b> 661,00 €

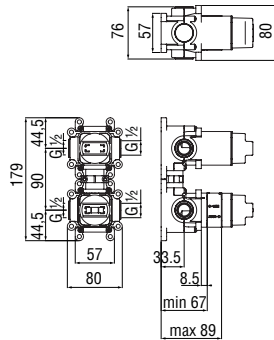

### Techbox 2 vie, parte incasso necessaria

- Deviatore a 2 vie ceramico
- Ingresso e uscita acqua  $\varnothing$  1/2"
- Adatta anche a montaggio su cartongesso

- WE81102 160,00 €



CARTRIDGE  
WARRANTY



RCR350  
39,00 €



RCR201/35FSC  
39,00 €



NR00212/30  
85,00 €

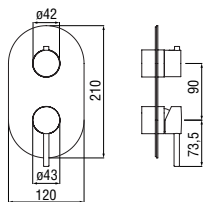

### Parte esterna monocomando incasso a 2-3 vie

- Limitatore di portata con freno al 50%
- Tenuta o-ring invisibile, fissaggio a parete impermeabile

Cromo lucido	WE81102/TCR	413,00 €
Inox spazzolato	WE81102/TIX	618,00 €
Grafite spazzolato PVD	WE81102/TGUP	<b>NEW</b> 661,00 €
Mora opaco	WE81102/TBM	618,00 €
Neve opaco	WE81102/TWM	618,00 €
Miele spazzolato PVD	WE81102/TCGP	<b>NEW</b> 661,00 €
Argilla spazzolato PVD	WE81102/TRTP	<b>NEW</b> 661,00 €

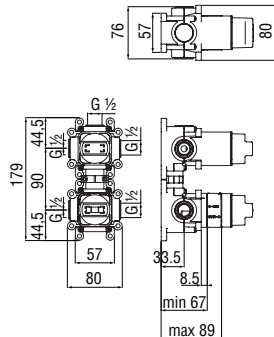

### Techbox 3 vie, parte incasso necessaria

- Deviatore a 3 vie ceramico
- Ingresso e uscita acqua  $\varnothing$  1/2"
- Adatta anche a montaggio su cartongesso

- WE81103 184,00 €



CARTRIDGE  
WARRANTY



RCR350  
39,00 €



RCR201/35C  
39,00 €

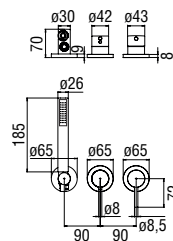

NR00212/32  
85,00 €

**Parte esterna monocomando incasso a 2 vie**

- Limitatore di portata con freno al 50%
- Doccetta monogetto e flessibile 150 cm
- Deviatore a 2 vie
- Abbinamento libero per la seconda via

Cromo lucido	WESK100/ITCR	431,00 €
Inox spazzolato	WESK100/ITIX	645,00 €
Grafite spazzolato PVD	WESK100/ITGUP	NEW 690,00 €
Mora opaco	WESK100/ITBM	645,00 €
Neve opaco	WESK100/ITWM	645,00 €
Miele spazzolato PVD	WESK100/ITCGP	NEW 690,00 €
Argilla spazzolato PVD	WESK100/ITRTP	NEW 690,00 €



NR00212/22CR  
85,00 €

**Parte incasso necessaria**

- Ingresso e uscita acqua  $\varnothing$  1/2"

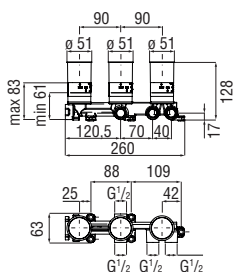

- WE81200/T NEW 334,00 €



CARTRIDGE  
WARRANTY



RCR350  
39,00 €

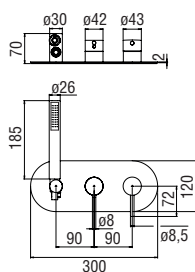

RCR201/35FSC  
39,00 €

**Parte esterna monocomando incasso a 2 vie**

- Limitatore di portata con freno al 50%
- Doccetta monogetto e flessibile 150 cm
- Deviatore a 2 vie
- Abbinamento libero per la seconda via

Cromo lucido	WESK100/TCR	431,00 €
Inox spazzolato	WESK100/TIX	645,00 €
Grafite spazzolato PVD	WESK100/TGUP	NEW 690,00 €
Mora opaco	WESK100/TBM	645,00 €
Neve opaco	WESK100/TWM	645,00 €
Miele spazzolato PVD	WESK100/TCGP	NEW 690,00 €
Argilla spazzolato PVD	WESK100/TRTP	NEW 690,00 €



NR00212/22CR  
85,00 €

**Parte incasso necessaria**

- Ingresso e uscita acqua  $\varnothing$  1/2"

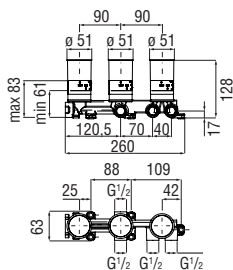

- WE81200/T NEW 334,00 €



CARTRIDGE  
WARRANTY



RCR350  
39,00 €



RCR201/35FSC  
39,00 €

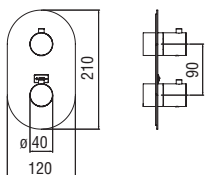

**Parte esterna termostatico a 1 via**

- Blocco di sicurezza 38° C
- Montaggio verticale o orizzontale

Cromo lucido	WE00101/TCR	414,00 €
Inox spazzolato	WE00101/TIX	621,00 €
Grafite spazzolato PVD	WE00101/TGUP	662,00 €
Mora opaco	WE00101/TBM	621,00 €
Neve opaco	WE00101/TWM	621,00 €
Miele spazzolato PVD	WE00101/TCGP	<b>NEW</b> 662,00 €
Argilla spazzolato PVD	WE00101/TRTP	662,00 €

 NR00008  
34,00 €

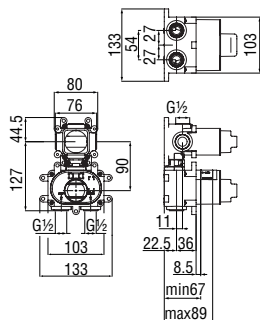

**Wellbox 1 via, parte incasso necessaria**

- Ingresso e uscita acqua  $\varnothing$  1/2"
- Rubinetti di chiusura
- Valvole antiritorno
- Adatta anche a montaggio su cartongesso
- Filtri di ricambio cartuccia inclusi nella confezione

- WE00101 167,00 €

 RCR201/5  
58,00 €

 RVT200/5D  
18,00 €

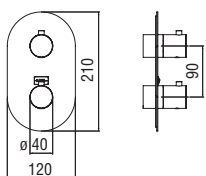

**Parte esterna termostatico a 2 vie**

- Blocco di sicurezza 38° C
- Montaggio verticale o orizzontale

Cromo lucido	WE00102/TCR	414,00 €
Inox spazzolato	WE00102/TIX	621,00 €
Grafite spazzolato PVD	WE00102/TGUP	662,00 €
Mora opaco	WE00102/TBM	621,00 €
Neve opaco	WE00102/TWM	621,00 €
Miele spazzolato PVD	WE00102/TCGP	<b>NEW</b> 662,00 €
Argilla spazzolato PVD	WE00102/TRTP	662,00 €

 NR00008  
34,00 €

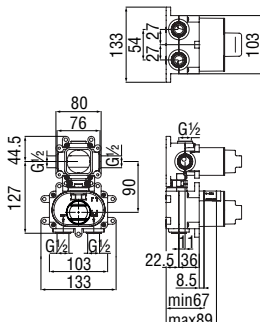

**Wellbox 2 vie, parte incasso necessaria**

- Ingresso e uscita acqua  $\varnothing$  1/2"
- Rubinetti di chiusura
- Valvole antiritorno
- Adatta anche a montaggio su cartongesso
- Filtri di ricambio cartuccia inclusi nella confezione

- WE00102 215,00 €

 RCR201/5  
58,00 €

 RCR201/28  
39,00 €

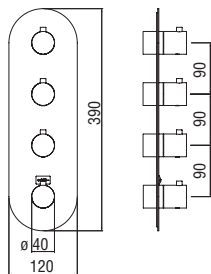

**Parte esterna termostatico a 3 vie**

- Blocco di sicurezza 38° C
- Montaggio verticale o orizzontale

Cromo lucido	WE00103/TCR	856,00 €
Inox spazzolato	WE00103/TIX	1.283,00 €
Grafite spazzolato PVD	WE00103/TGUP	1.368,00 €
Mora opaco	WE00103/TBM	1.283,00 €
Neve opaco	WE00103/TWM	1.283,00 €
Miele spazzolato PVD	WE00103/TCGP	<b>NEW</b> 1.368,00 €
Argilla spazzolato PVD	WE00103/TRTP	1.368,00 €



NR00008  
34,00 €

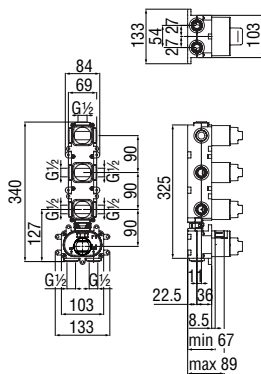

**Wellbox 3 vie, parte incasso necessaria**

- Ingresso e uscita acqua ø 1/2"
- Rubinetti di chiusura
- Valvole antiritorno
- Adatta anche a montaggio su cartongesso
- Filtri di ricambio cartuccia inclusi nella confezione

-	WE00103	318,00 €
---	---------	----------



RCR201/5  
58,00 €



RVT200/5D  
18,00 €

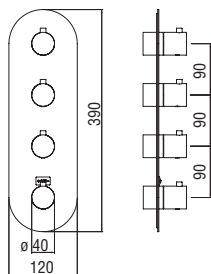

**Parte esterna termostatico a 4 vie**

- Blocco di sicurezza 38° C
- Montaggio verticale o orizzontale

Cromo lucido	WE00104/TCR	856,00 €
Inox spazzolato	WE00104/TIX	1.283,00 €
Grafite spazzolato PVD	WE00104/TGUP	1.368,00 €
Mora opaco	WE00104/TBM	1.283,00 €
Neve opaco	WE00104/TWM	1.283,00 €
Miele spazzolato PVD	WE00104/TCGP	<b>NEW</b> 1.368,00 €
Argilla spazzolato PVD	WE00104/TRTP	1.368,00 €



NR00008  
34,00 €

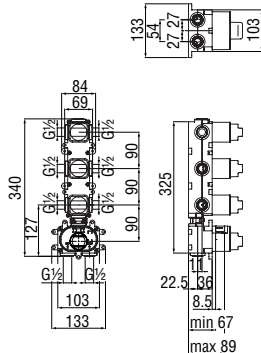

**Wellbox 4 vie, parte incasso necessaria**

- Ingresso e uscita acqua ø 1/2"
- Rubinetti di chiusura
- Valvole antiritorno
- Adatta anche a montaggio su cartongesso
- Filtri di ricambio cartuccia inclusi nella confezione

-	WE00104	360,00 €
---	---------	----------



RCR201/5  
58,00 €



RCR201/28  
39,00 €



RVT200/5D  
18,00 €



RUBINETTERIA NOBILI

# ACQUERELLI

Centro Stile Nobili

La freschezza dinamica di Acquerelli accompagna con entusiasmo le indimenticabili sensazioni della prima casa: un momento magico della nostra vita. La spensieratezza della gioventù, l'irrefrenabile allegria, la vivacità dei colori: un rifugio intimo e speciale, un luogo che parla di noi, riflette i nostri gusti e la nostra personalità.



Cromo lucido



Inox spazzolato



Mora opaco

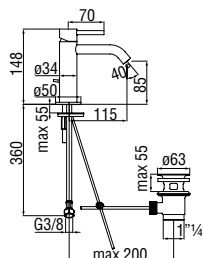

**Monocomando**

- Limitatore di portata con freno al 50%
- Aeratore anticalcare M 16,5 x 1, portata 5 l/min
- Scarico 1 1/4" con sistema brevettato SNAP
- Flessibili inox  $\varnothing$  3/8"

Cromo lucido	AQ93118/15CR	166,00 €
Inox spazzolato	AQ93118/15IX	249,00 €
Mora opaco	AQ93118/15BM	<b>NEW</b> 249,00 €



CARTRIDGE  
WARRANTY



RCR280/D  
39,00 €

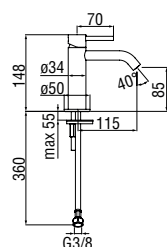

RAEK219/28  
58,00 € - 10 pz.

**Monocomando**

- Limitatore di portata con freno al 50%
- Aeratore anticalcare M 16,5 x 1, portata 5 l/min
- Senza scarico
- Flessibili inox  $\varnothing$  3/8"

Cromo lucido	AQ93118/17CR	162,00 €
Inox spazzolato	AQ93118/17IX	244,00 €
Mora opaco	AQ93118/17BM	<b>NEW</b> 244,00 €



CARTRIDGE  
WARRANTY



RCR280/D  
39,00 €

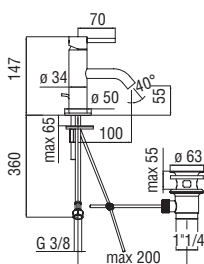

RAEK219/28  
58,00 € - 10 pz.

**Monocomando**

- Limitatore di portata con freno al 50%
- Aeratore anticalcare M 16,5 x 1, portata 5 l/min
- Scarico 1 1/4" con sistema brevettato SNAP
- Flessibili inox  $\varnothing$  3/8"

Cromo lucido	AQ93118/1CR	159,00 €
Inox spazzolato	AQ93118/1IX	238,00 €
Mora opaco	AQ93118/1BM	<b>NEW</b> 238,00 €



CARTRIDGE  
WARRANTY



RCR280/D  
39,00 €

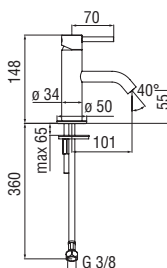

RAEK219/28  
58,00 € - 10 pz.

**Monocomando**

- Limitatore di portata con freno al 50%
- Aeratore anticalcare M 16,5 x 1, portata 5 l/min
- Senza scarico
- Flessibili inox  $\varnothing$  3/8"

Cromo lucido	AQ93118/2CR	155,00 €
Inox spazzolato	AQ93118/2IX	234,00 €
Mora opaco	AQ93118/2BM	<b>NEW</b> 234,00 €



CARTRIDGE  
WARRANTY



RCR280/D  
39,00 €

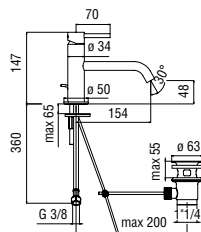

RAEK219/28  
58,00 € - 10 pz.

**Monocomando bocca lunga**

- Limitatore di portata con freno al 50%
- Aeratore anticalcare M 16,5 x 1, portata 5 l/min
- Scarico 1 1/4" con sistema brevettato SNAP
- Flessibili inox ø 3/8"

Cromo lucido	AQ93118/20CR	176,00 €
Inox spazzolato	AQ93118/20IX	264,00 €
Mora opaco	AQ93118/20BM	<b>NEW</b> 264,00 €



CARTRIDGE  
WARRANTY



RCR280/D  
39,00 €

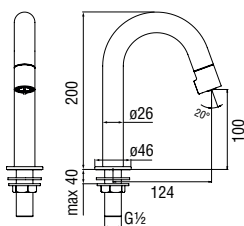

RAEK219/28  
58,00 € - 10 pz.

**Rubinetto monoacqua**

- Aeratore anticalcare M 16,5 x 1
- Senza scarico
- Flessibili inox ø 3/8"

Cromo lucido	AQ93236CR	126,00 €
Inox spazzolato	AQ93236IX	190,00 €
Mora opaco	AQ93236BM	<b>NEW</b> 190,00 €



RVT200/73  
20,00 €

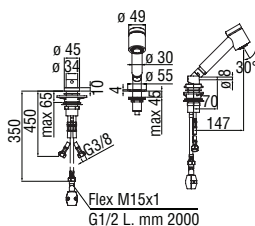

RAEK222/26  
45,00 € - 10 pz.

**Monocomando con doccetta estraibile**

- Limitatore di portata con freno al 50%
- Doccetta a 2 getti estraibile
- Flessibili inox ø 3/8"

Cromo lucido	AQ93660CR	287,00 €
--------------	-----------	----------



CARTRIDGE  
WARRANTY

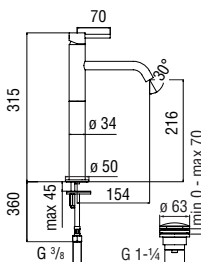

RCR280/D  
39,00 €

**Monocomando a bacinella**

- Limitatore di portata con freno al 50%
- Aeratore anticalcare M 16,5 x 1, portata 5 l/min
- Scarico 1 1/4" push
- Flessibili inox ø 3/8"

Cromo lucido	AQ93128/2CR	282,00 €
Inox spazzolato	AQ93128/2IX	423,00 €
Mora opaco	AQ93128/2BM	<b>NEW</b> 423,00 €



CARTRIDGE  
WARRANTY



RCR280/D  
39,00 €



RAEK219/28  
58,00 € - 10 pz.

## LAVABO

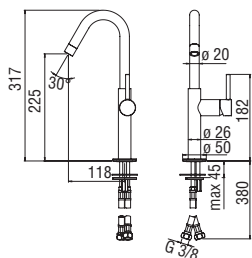
**Monocomando**

- Limitatore di portata con freno al 50%
- Aeratore anticalcare M 16 x 1, portata 5 l/min
- Senza scarico
- Flessibili inox  $\varnothing$  3/8"

Cromo lucido	AQ93118/30CR	195,00 €
Inox spazzolato	AQ93118/30IX	293,00 €
Mora opaco	AQ93118/30BM	<b>NEW</b> 293,00 €



CARTRIDGE  
WARRANTY



RCR280/D  
39,00 €



RAEK222/12CR  
69,00 € - 10 pz.

## BIDET

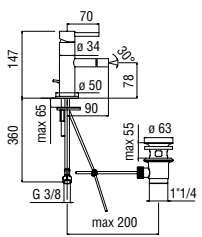
**Monocomando**

- Limitatore di portata con freno al 50%
- Aeratore anticalcare M 16,5 x 1, portata 5 l/min
- Getto orientabile
- Scarico 1 1/4" con sistema brevettato SNAP
- Flessibili inox  $\varnothing$  3/8"

Cromo lucido	AQ93119/1CR	159,00 €
Inox spazzolato	AQ93119/1IX	238,00 €
Mora opaco	AQ93119/1BM	<b>NEW</b> 238,00 €



CARTRIDGE  
WARRANTY



RCR280/D  
39,00 €



RAEK220/51CR  
21,00 € - 1 pz.

## VASCA

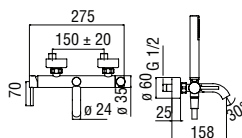
**Monocomando esterno con set doccia**

- Limitatore di portata con freno al 50%
- Aeratore anticalcare M 21,5 x 1
- Deviatore con ritorno automatico
- Supporto doccetta fisso
- Doccetta monogetto e flessibile 150 cm

Cromo lucido	AQ93110CR	315,00 €
Inox spazzolato	AQ93110IX	473,00 €
Mora opaco	AQ93110BM	<b>NEW</b> 473,00 €



CARTRIDGE  
WARRANTY



RCR280/D  
39,00 €



RAEK222/26  
45,00 € - 10 pz.

## DOCCIA

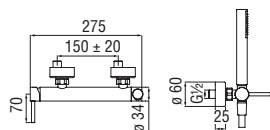
**Monocomando esterno con set doccia**

- Limitatore di portata con freno al 50%
- Supporto doccetta fisso
- Doccetta monogetto e flessibile 150 cm

Cromo lucido	AQ93130/1CR	236,00 €
Inox spazzolato	AQ93130/1IX	353,00 €
Mora opaco	AQ93130/1BM	<b>NEW</b> 353,00 €



CARTRIDGE  
WARRANTY



RCR280/D  
39,00 €

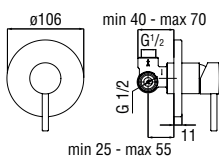

### Monocomando incasso a 1 via

- Limitatore di portata con freno al 50%
- Ingresso acqua calda e acqua fredda  $\varnothing$  1/2"
- Uscita  $\varnothing$  1/2"
- Parte esterna e parte incasso

Cromo lucido	AQ93108CR	<b>MOD</b>	132,00 €
Inox spazzolato	AQ93108IX	<b>MOD</b>	200,00 €
Mora opaco	AQ93108BM	<b>NEW</b>	200,00 €



CARTRIDGE  
WARRANTY



RCR350  
39,00 €



NR00212/10CR  
43,00 €

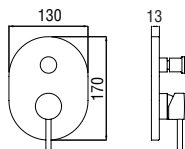

### Monocomando incasso a 2 vie

- Limitatore di portata con freno al 50%
- Deviatore con ritorno automatico

Cromo lucido	AQ93100/ECR	<b>MOD</b>	174,00 €
Inox spazzolato	AQ93100/EIX	<b>MOD</b>	260,00 €
Mora opaco	AQ93100/EBM	<b>NEW</b>	260,00 €



NR00212/13CR  
57,00 €

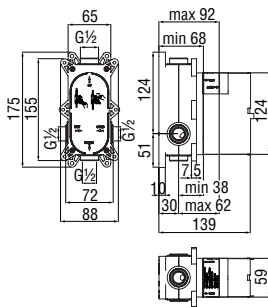

### Easybox 2 vie, parte incasso necessaria

- Ingresso e uscita acqua  $\varnothing$  1/2"
- Adatta anche a montaggio su cartongesso

Nota: disponibile il dispositivo antireflusso RVREN1717 (opzionale)

-	WE81100	135,00 €
---	---------	----------



CARTRIDGE  
WARRANTY



RCR350  
39,00 €

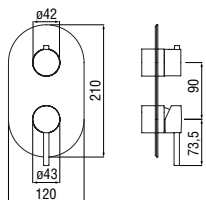

RVREN1717  
33,00 €

**Parte esterna monocomando incasso a 2-3 vie**

- Limitatore di portata con freno al 50%
- Tenuta o-ring invisibile, fissaggio a parete impermeabile

Cromo lucido	WE81102/TCR	413,00 €
Inox spazzolato	WE81102/TIX	618,00 €
Mora opaco	WE81102/TBM	618,00 €

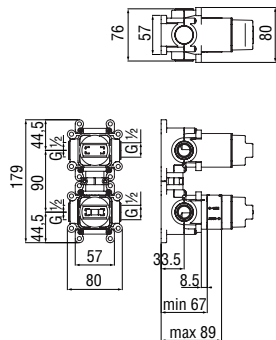
**Techbox 2 vie, parte incasso necessaria**

- Deviatore a 2 vie ceramico
- Ingresso e uscita acqua  $\varnothing$  1/2"
- Adatta anche a montaggio su cartongesso

-	WE81102	160,00 €
---	---------	----------



CARTRIDGE  
WARRANTY



RCR350  
39,00 €



RCR201/35FSC  
39,00 €

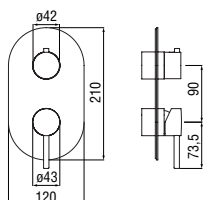

NR00212/30  
85,00 €

**Parte esterna monocomando incasso a 2-3 vie**

- Limitatore di portata con freno al 50%
- Tenuta o-ring invisibile, fissaggio a parete impermeabile

Cromo lucido	WE81102/TCR	413,00 €
Inox spazzolato	WE81102/TIX	618,00 €
Mora opaco	WE81102/TBM	618,00 €

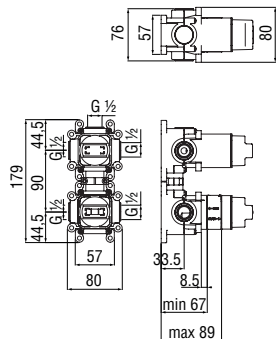
**Techbox 3 vie, parte incasso necessaria**

- Deviatore a 3 vie ceramico
- Ingresso e uscita acqua  $\varnothing$  1/2"
- Adatta anche a montaggio su cartongesso

-	WE81103	184,00 €
---	---------	----------



CARTRIDGE  
WARRANTY



RCR350  
39,00 €



RCR201/35C  
39,00 €



NR00212/32  
85,00 €

RUBINETTERIA NOBILI

# UNO

Piet Billekens

Semplicità raffinata e stile essenziale perfettamente bilanciati, in grado di adattarsi con armonia all'interno di tutti i progetti architettonici. La manopola di comando riprende i tratti lineari della bocca di miscelazione, alla ricerca del più elevato comfort di utilizzo e della massima sostenibilità ambientale.



Cromo lucido

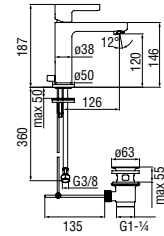

Mora opaco

**Monocomando**

- Limitatore di portata con freno al 50%
- Aeratore anticalcare M 24 x 1
- Scarico 1 1/4" con sistema brevettato SNAP
- Flessibili inox ø 3/8"

Cromo lucido	LRI16118/1CR	257,00 €
Mora opaco	LRI16118/1BM	386,00 €

20 YEARS

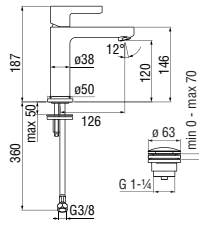
CARTRIDGE  
WARRANTYRCR280/D  
39,00 €RAEK220/37CR  
47,00 € - 10 pz.**Monocomando**

- Limitatore di portata con freno al 50%
- Aeratore anticalcare M 24 x 1
- Scarico 1 1/4" push
- Flessibili inox ø 3/8"

Cromo lucido	LRI16118/2CR	270,00 €
Mora opaco	LRI16118/2BM	405,00 €

20 YEARS

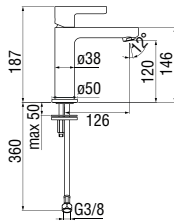
CARTRIDGE  
WARRANTYRCR280/D  
39,00 €RAEK220/37CR  
47,00 € - 10 pz.**Monocomando**

- Limitatore di portata con freno al 50%
- Aeratore anticalcare M 24 x 1
- Senza scarico
- Flessibili inox ø 3/8"

Cromo lucido	LRI16118/3CR	254,00 €
Mora opaco	LRI16118/3BM	380,00 €

20 YEARS

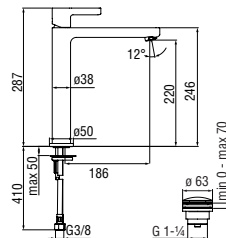
CARTRIDGE  
WARRANTYRCR280/D  
39,00 €RAEK220/37CR  
47,00 € - 10 pz.**Monocomando a bacinella**

- Limitatore di portata con freno al 50%
- Aeratore anticalcare M 24 x 1
- Scarico 1 1/4" push
- Flessibili inox ø 3/8"

Cromo lucido	LRI16128/2CR	418,00 €
Mora opaco	LRI16128/2BM	627,00 €

20 YEARS

CARTRIDGE  
WARRANTYRCR280/D  
39,00 €RAEK220/37CR  
47,00 € - 10 pz.

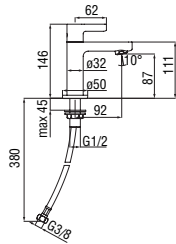

**Rubinetto monoacqua**

- Aeratore anticalcare M 24 x 1
- Senza scarico
- Flessibile inox ø 3/8"

Cromo lucido	LR116237CR	207,00 €
Mora opaco	LR116237BM	311,00 €



RVT200/5D  
18,00 €

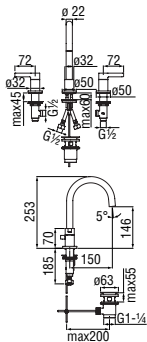

RAEK220/37CR  
47,00 € - 10 pz.

**Batteria 3 fori**

- Aeratore anticalcare M 18,5 x 1, portata 5 l/min
- Bocca girevole
- Scarico 1 1/4" con sistema brevettato SNAP

Cromo lucido	LR116211/1T1CR	396,00 €
Mora opaco	LR116211/1T1BM	595,00 €



RVT200/5S  
18,00 €



RVT200/5D  
18,00 €

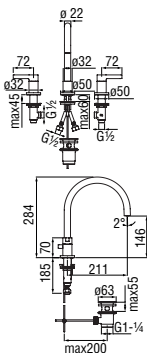

RAEK222/44  
61,00 € - 10 pz.

**Batteria 3 fori con bocca lunga**

- Aeratore anticalcare M 18,5 x 1, portata 5 l/min
- Bocca girevole
- Scarico 1 1/4" con sistema brevettato SNAP

Cromo lucido	LR116211/5T1CR	422,00 €
Mora opaco	LR116211/5T1BM	633,00 €



RVT200/5D  
18,00 €



RVT200/5S  
18,00 €



RAEK222/44  
61,00 € - 10 pz.

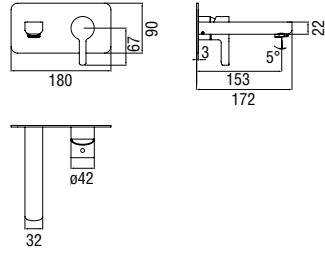

**Parte esterna monocomando a parete**

- Limitatore di portata con freno al 50%
- Aeratore anticalcare M 24 x 1
- Lunghezza bocca 170 mm
- Senza scarico

Cromo lucido	LR116198CR	269,00 €
Mora opaco	LR116198BM	403,00 €

RAEK220/37CR  
47,00 € - 10 pz.

NR00212/10CR  
43,00 €

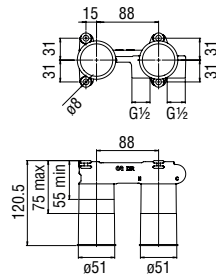

**Allbox, parte incasso necessaria**

- Ingresso acqua calda e acqua fredda ø 1/2"
- Uscita ø 1/2"

-	WE00198	<b>MOD</b>	125,00 €
---	---------	------------	----------

CARTRIDGE WARRANTY

RCR350  
39,00 €

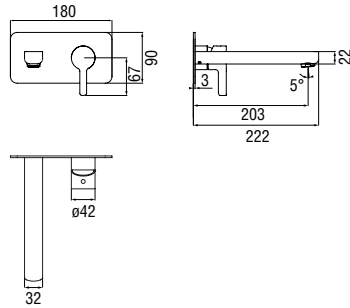

**Parte esterna monocomando a parete bocca lunga**

- Limitatore di portata con freno al 50%
- Aeratore anticalcare M 24 x 1
- Lunghezza bocca 220 mm
- Senza scarico

Cromo lucido	LR116198/1CR	299,00 €
Mora opaco	LR116198/1BM	447,00 €

RAEK220/37CR  
47,00 € - 10 pz.

NR00212/10CR  
43,00 €

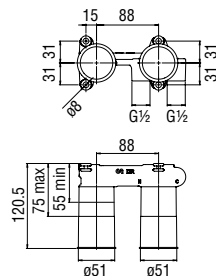

**Allbox, parte incasso necessaria**

- Ingresso acqua calda e acqua fredda ø 1/2"
- Uscita ø 1/2"

-	WE00198	<b>MOD</b>	125,00 €
---	---------	------------	----------

CARTRIDGE WARRANTY

RCR350  
39,00 €

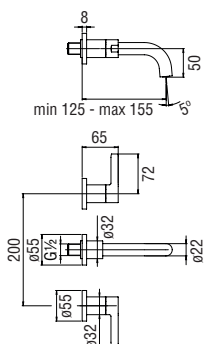
**Parte esterna batteria 3 fori a parete**

- Aeratore anticalcare M 18,5 x 1, portata 5 l/min
- Lunghezza bocca min 125 - max 155 mm
- Senza scarico

Cromo lucido	LR116298/ET1CR	264,00 €
Mora opaco	LR116298/ET1BM	396,00 €



RVT200/5D  
18,00 €



RVT200/5S  
18,00 €



RAEK222/44  
61,00 € - 10 pz.

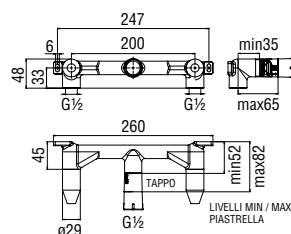
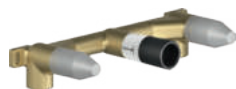

NR00212/28  
41,00 €

**Allbox, parte incasso necessaria**

- Ingresso acqua calda e acqua fredda  $\varnothing$  1/2"
- Uscita  $\varnothing$  1/2"

-	WE00298	130,00 €
---	---------	----------

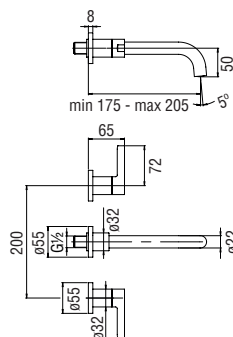
**Parte esterna batteria 3 fori a parete con bocca lunga**

- Aeratore anticalcare M 18,5 x 1, portata 5 l/min
- Lunghezza bocca min 175 - max 205 mm
- Senza scarico

Cromo lucido	LR116298/1ET1CR	280,00 €
Mora opaco	LR116298/1ET1BM	420,00 €



RVT200/5D  
18,00 €



RVT200/5S  
18,00 €



RAEK222/44  
61,00 € - 10 pz.

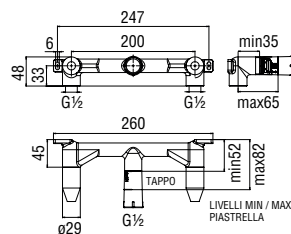
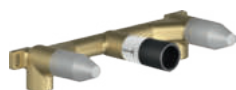

NR00212/28  
41,00 €

**Allbox, parte incasso necessaria**

- Ingresso acqua calda e acqua fredda  $\varnothing$  1/2"
- Uscita  $\varnothing$  1/2"

-	WE00298	130,00 €
---	---------	----------

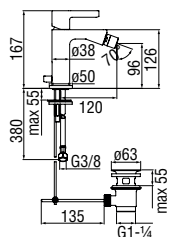

**Monocomando**

- Limitatore di portata con freno al 50%
- Aeratore anticalcare M 22 x 1
- Getto orientabile
- Scarico 1 1/4" con sistema brevettato SNAP
- Flessibili inox Ø 3/8"

Cromo lucido	LR116119/1CR	257,00 €
Mora opaco	LR116119/1BM	386,00 €



CARTRIDGE  
WARRANTY



RCR280/D  
39,00 €



RAE219/61CR  
23,00 € - 1 pz.

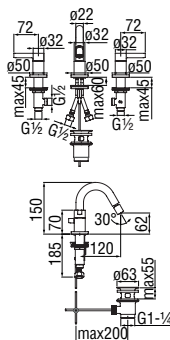

**Batteria 3 fori**

- Aeratore anticalcare M 18,5 x 1, portata 5 l/min
- Bocca girevole
- Getto orientabile
- Scarico 1 1/4" con sistema brevettato SNAP
- Flessibili inox Ø 3/8"

Cromo lucido	LR116215/1T1CR	396,00 €
Mora opaco	LR116215/1T1BM	595,00 €



RVT200/5D  
18,00 €



RVT200/5S  
18,00 €



RAE222/44CR  
22,00 € - 10 pz.

**BORDO VASCA**

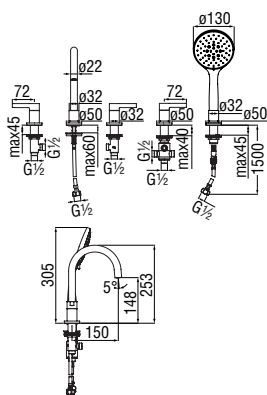

**Batteria 5 fori bordo vasca**

- Aeratore anticalcare M 18,5 x 1
- Deviatore a 2 vie
- Doccetta a 3 getti estraibile

Cromo lucido	WEBK204/T1LR CR	<b>MOD</b>	754,00 €
Mora opaco	WEBK204/T1LR BM	<b>MOD</b>	1.130,00 €



RVT200/5D  
18,00 €



RVT200/5S  
18,00 €



RAEK222/23  
43,00 € - 10 pz.

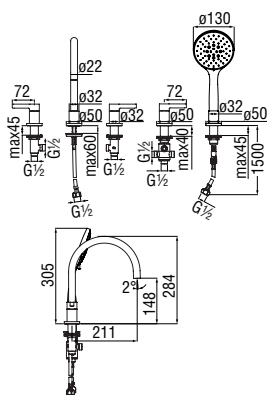

**Batteria 5 fori bordo vasca con bocca lunga**

- Aeratore anticalcare M 18,5 x 1
- Deviatore a 2 vie
- Doccetta a 3 getti estraibile

Cromo lucido	WEBK204/1T1LR CR	<b>MOD</b>	805,00 €
Mora opaco	WEBK204/1T1LR BM	<b>MOD</b>	1.208,00 €



RVT200/5D  
18,00 €



RVT200/5S  
18,00 €



RAEK222/23  
43,00 € - 10 pz.

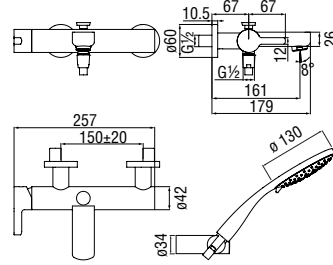

**Monocomando esterno con set doccia**

- Limitatore di portata con freno al 50%
- Aeratore anticalcare M 28 x 1
- Deviatore con ritorno automatico
- Supporto doccetta orientabile
- Doccetta a 3 getti e flessibile 150 cm

Cromo lucido	LR116110CR	<b>MOD</b>	393,00 €
Mora opaco	LR116110BM	<b>MOD</b>	589,00 €



CARTRIDGE  
WARRANTY



RCR350  
39,00 €



RAEK220/14CR  
45,00 € - 10 pz.

DOCCIA

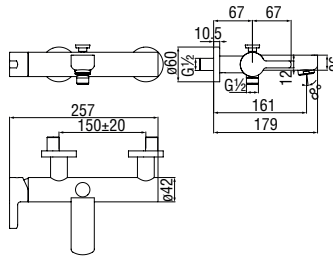

**Monocomando esterno**

- Limitatore di portata con freno al 50%
- Aeratore anticalcare M 28 x 1
- Deviatore con ritorno automatico
- Uscita ø 1/2"

Cromo lucido	LR116110/1CR	364,00 €
Mora opaco	LR116110/1BM	546,00 €



CARTRIDGE  
WARRANTY



RCR350  
39,00 €



RAEK220/14CR  
45,00 € - 10 pz.

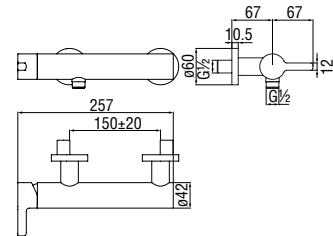

**Monocomando esterno**

- Limitatore di portata con freno al 50%
- Uscita ø 1/2"

Cromo lucido	LR116130CR	217,00 €
Mora opaco	LR116130BM	327,00 €



CARTRIDGE  
WARRANTY



RCR350  
39,00 €

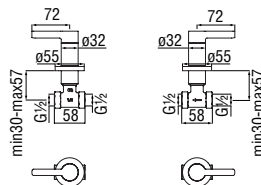

**Coppia di rubinetti d'arresto a incasso**

- Ingresso a 2 vie
- Uscite ø 1/2"

Cromo lucido	LRK116208/1T1CR	294,00 €
Mora opaco	LRK116208/1T1BM	442,00 €



RVT200/26  
18,00 €



NR00212/26  
38,00 €

**Deviatore 2 vie**

- Ingresso a 2 vie
- Uscite  $\varnothing$  1/2"

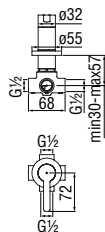

Cromo lucido	LR116160/TICR	230,00 €
Mora opaco	LR116160/T1BM	347,00 €



NR00212/27  
24,00 €

**Monocomando incasso a 1 via**

- Limitatore di portata con freno al 50%
- Tenuta o-ring invisibile
- Fissaggio a parete impermeabile
- Ingresso acqua calda e acqua fredda  $\varnothing$  1/2"
- Uscita  $\varnothing$  1/2"
- Parte esterna e parte incasso

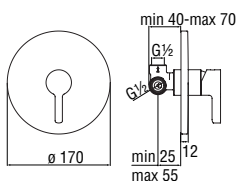

Cromo lucido	LR116108CR	175,00 €
Mora opaco	LR116108BM	261,00 €



CARTRIDGE  
WARRANTY



RCR350  
39,00 €



NR00212/10CR  
43,00 €

**Parte esterna monocomando incasso a 2 vie**

- Limitatore di portata con freno al 50%
- Deviatore con ritorno automatico
- Tenuta o-ring invisibile
- Fissaggio a parete impermeabile

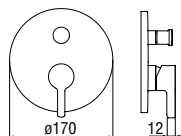

Cromo lucido	LR116100/ECR	229,00 €
Mora opaco	LR116100/EBM	345,00 €



NR00212/13CR  
57,00 €

**Easybox 2 vie, parte incasso necessaria**

- Ingresso e uscita acqua  $\varnothing$  1/2"
- Adatta anche a montaggio su cartongesso

Nota: disponibile il dispositivo antireflusso RVREN1717 (opzionale)

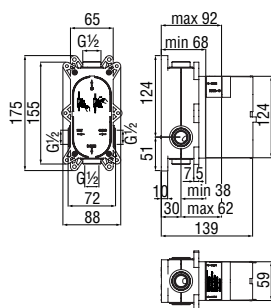

-	WE81100	135,00 €
---	---------	----------



CARTRIDGE  
WARRANTY



RCR350  
39,00 €

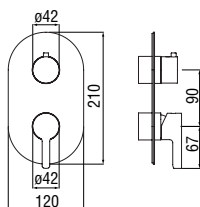

RVREN1717  
33,00 €

**Parte esterna monocomando incasso a 2-3 vie**

- Limitatore di portata con freno al 50%
- Tenuta o-ring invisibile
- Fissaggio a parete impermeabile

Cromo lucido	WE81102/LRCR	413,00 €
Mora opaco	WE81102/LRBM	618,00 €

**Techbox 2 vie, parte incasso necessaria**

- Deviatore a 2 vie ceramico
- Ingresso e uscita acqua ø 1/2"
- Adatta anche a montaggio su cartongesso

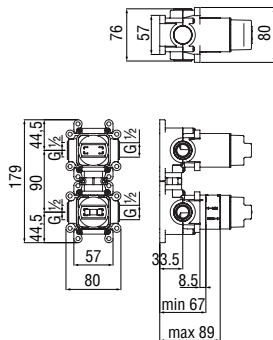

-	WE81102	160,00 €
---	---------	----------



CARTRIDGE  
WARRANTY



RCR350  
39,00 €



RCR201/35FSC  
39,00 €

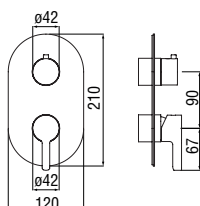

NR00212/30  
85,00 €

**Parte esterna monocomando incasso a 2-3 vie**

- Limitatore di portata con freno al 50%
- Tenuta o-ring invisibile
- Fissaggio a parete impermeabile

Cromo lucido	WE81102/LRCR	413,00 €
Mora opaco	WE81102/LRBM	618,00 €

**Techbox 3 vie, parte incasso necessaria**

- Deviatore a 3 vie ceramico
- Ingresso e uscita acqua ø 1/2"
- Adatta anche a montaggio su cartongesso

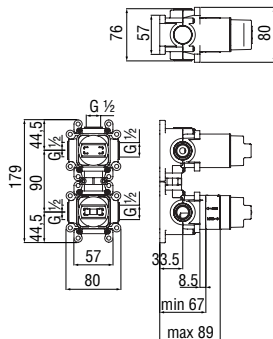

-	WE81103	184,00 €
---	---------	----------



CARTRIDGE  
WARRANTY



RCR350  
39,00 €



RCR201/35C  
39,00 €



NR00212/32  
85,00 €





RUBINETTERIA NOBILI

# YOYO

Centro Stile Nobili

Armonia essenziale e semplicità contemporanea: Yoyo esprime carattere e personalità attraverso una linea morbida e sinuosa, resa possibile dalla cartuccia a immersione Nobili Widd® dal diametro di appena 28 millimetri ed enfatizzata dall'aeratore a scomparsa che ne definisce i tratti e accentua l'eleganza.



Cromo lucido



Mora opaco

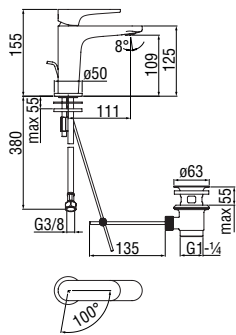

**Monocomando a risparmio energetico**

- Limitatore di energia con apertura in acqua fredda
- Limitatore di portata con freno al 50%
- Aeratore anticalcare M 24 x 1, portata 5 l/min
- Scarico 1 1/4" con sistema brevettato SNAP
- Flessibili inox ø 3/8"

Cromo lucido	YOE126118/1CR	156,00 €
Mora opaco	YOE126118/1BM	235,00 €



CARTRIDGE WARRANTY



RCR280/DECO 50,00 €



RAEK222/40 56,00 € - 10 pz.

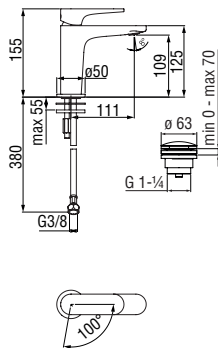

**Monocomando a risparmio energetico**

- Limitatore di energia con apertura in acqua fredda
- Limitatore di portata con freno al 50%
- Aeratore anticalcare M 24 x 1, portata 5 l/min
- Scarico 1 1/4" push
- Flessibili inox ø 3/8"

Cromo lucido	YOE126118/2CR	170,00 €
Mora opaco	YOE126118/2BM	255,00 €



CARTRIDGE WARRANTY



RCR280/DECO 50,00 €



RAEK222/40 56,00 € - 10 pz.

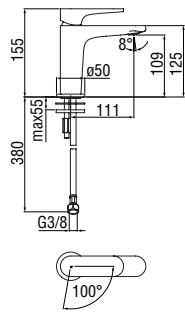

**Monocomando a risparmio energetico**

- Limitatore di energia con apertura in acqua fredda
- Limitatore di portata con freno al 50%
- Aeratore anticalcare M 24 x 1, portata 5 l/min
- Senza scarico
- Flessibili inox ø 3/8"

Cromo lucido	YOE126118/3CR	153,00 €
Mora opaco	YOE126118/3BM	230,00 €



CARTRIDGE WARRANTY



RCR280/DECO 50,00 €



RAEK222/40 56,00 € - 10 pz.

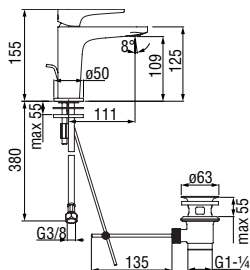

**Monocomando**

- Limitatore di portata con freno al 50%
- Aeratore anticalcare M 24 x 1, portata 5 l/min
- Scarico 1 1/4" con sistema brevettato SNAP
- Flessibili inox ø 3/8"

Cromo lucido	YO126118/1CR	155,00 €
Mora opaco	YO126118/1BM	234,00 €



CARTRIDGE WARRANTY



RCR280/D 39,00 €

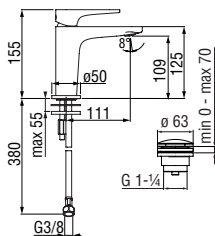

RAEK222/40 56,00 € - 10 pz.

**Monocomando**

- Limitatore di portata con freno al 50%
- Aeratore anticalcare M 24 x 1, portata 5 l/min
- Scarico 1 1/4" push
- Flessibili inox ø 3/8"

Cromo lucido	YO126118/2CR	169,00 €
Mora opaco	YO126118/2BM	254,00 €



CARTRIDGE  
WARRANTY



RCR280/D  
39,00 €

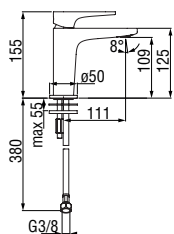

RAEK222/40  
56,00 € - 10 pz.

**Monocomando**

- Limitatore di portata con freno al 50%
- Aeratore anticalcare M 24 x 1, portata 5 l/min
- Senza scarico
- Flessibili inox ø 3/8"

Cromo lucido	YO126118/3CR	152,00 €
Mora opaco	YO126118/3BM	228,00 €



CARTRIDGE  
WARRANTY



RCR280/D  
39,00 €

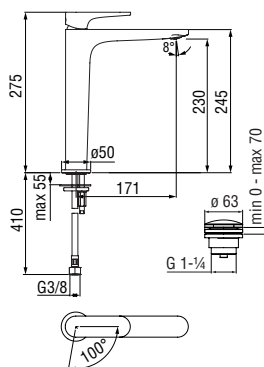

RAEK222/40  
56,00 € - 10 pz.

**Monocomando a bacinella a risparmio energetico**

- Limitatore di energia con apertura in acqua fredda
- Limitatore di portata con freno al 50%
- Aeratore anticalcare M 24 x 1, portata 5 l/min
- Scarico 1 1/4" push
- Flessibili inox ø 3/8"

Cromo lucido	YOE126128/2CR	316,00 €
Mora opaco	YOE126128/2BM	476,00 €



CARTRIDGE  
WARRANTY



RCR280/DECO  
50,00 €

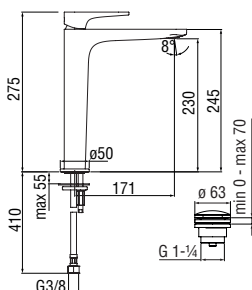

RAEK222/40  
56,00 € - 10 pz.

**Monocomando a bacinella**

- Limitatore di portata con freno al 50%
- Aeratore anticalcare M 24 x 1, portata 5 l/min
- Scarico 1 1/4" push
- Flessibili inox ø 3/8"

Cromo lucido	YO126128/2CR	315,00 €
Mora opaco	YO126128/2BM	473,00 €



CARTRIDGE  
WARRANTY



RCR280/D  
39,00 €

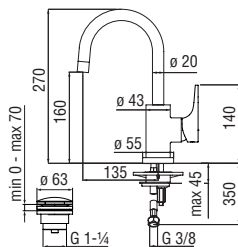

RAEK222/40  
56,00 € - 10 pz.

**Monocomando**

- Limitatore di portata con freno al 50%
- Aeratore anticalcare M 22 x 1
- Bocca girevole 360°
- Scarico 1 1/4" push
- Flessibili inox ø 3/8"

Cromo lucido	YO126338/2CR	210,00 €
Mora opaco	YO126338/2BM	314,00 €



CARTRIDGE  
WARRANTY



RCR360/D  
39,00 €

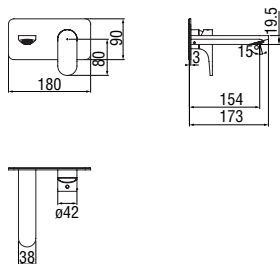

RAEK222/10CR  
58,00 € - 10 pz.

**Parte esterna monocomando a parete**

- Limitatore di portata con freno al 50%
- Aeratore anticalcare M 24 x 1, portata 5 l/min
- Lunghezza bocca 150 mm
- Senza scarico

Cromo lucido	YO126198CR	235,00 €
Mora opaco	YO126198BM	353,00 €



RAEK222/40  
56,00 € - 10 pz.

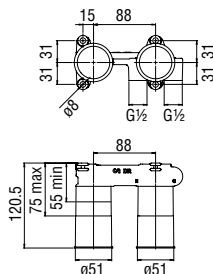

NR00212/10CR  
43,00 €

**Allbox, parte incasso necessaria**

- Ingresso acqua calda e acqua fredda ø 1/2"
- Uscita ø 1/2"

-	WE00198	<b>MOD</b>	125,00 €
---	---------	------------	----------



CARTRIDGE  
WARRANTY



RCR350  
39,00 €



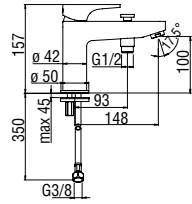

**Monocomando**

- Limitatore di portata con freno al 50%
- Aeratore anticalcare M 24 x 1
- Deviatore con ritorno automatico
- Valvole antiritorno
- Uscita ø 1/2"

Cromo lucido	YO126118/10CR	183,00 €
Mora opaco	YO126118/10BM	274,00 €



CARTRIDGE WARRANTY



RCR350/D 39,00 €



RAEK220/14CR 45,00 € - 10 pz.

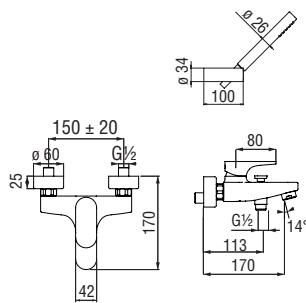

**Monocomando esterno con set doccia**

- Limitatore di portata con freno al 50%
- Aeratore anticalcare M 28 x 1
- Deviatore con ritorno automatico
- Supporto doccetta orientabile
- Doccetta monogetto e flessibile 150 cm

Cromo lucido	YO126110CR	278,00 €
Mora opaco	YO126110BM	417,00 €



CARTRIDGE WARRANTY



RCR340 39,00 €



RAEK219/41CR 47,00 € - 5 pz.

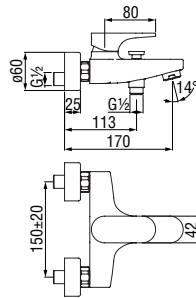

**Monocomando esterno**

- Limitatore di portata con freno al 50%
- Aeratore anticalcare M 28 x 1
- Deviatore con ritorno automatico
- Uscita ø 1/2"

Cromo lucido	YO126110/1CR	197,00 €
Mora opaco	YO126110/1BM	296,00 €



CARTRIDGE WARRANTY



RCR340 39,00 €



RAEK219/41CR 47,00 € - 5 pz.

DOCCIA

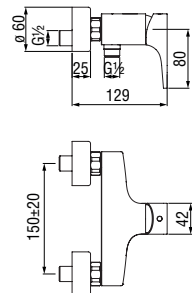

**Monocomando esterno**

- Limitatore di portata con freno al 50%
- Uscita ø 1/2"

Cromo lucido	YO126130CR	160,00 €
Mora opaco	YO126130BM	240,00 €



CARTRIDGE WARRANTY



RCR350 39,00 €

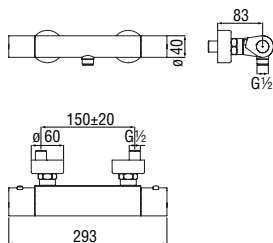

**Termostatico esterno**

- Blocco di sicurezza 38° C
- Valvole antiritorno
- Uscita ø 1/2"
- Filtri di ricambio cartuccia inclusi nella confezione

Cromo lucido	YO126030CR	218,00 €
Mora opaco	YO126030BM	328,00 €

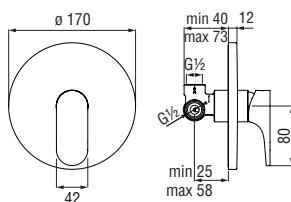
RCR201/6  
58,00 €RVT200/26  
18,00 €**Monocomando incasso a 1 via**

- Limitatore di portata con freno al 50%
- Ingresso acqua calda e acqua fredda ø 1/2"
- Uscita ø 1/2"
- Parte esterna e parte incasso

Cromo lucido	YO126108CR	93,00 €
Mora opaco	YO126108BM	141,00 €

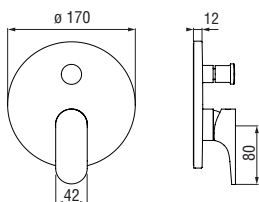
CARTRIDGE  
WARRANTYRCR350  
39,00 €NR00212/10CR  
43,00 €**Parte esterna monocomando incasso a 2 vie**

- Limitatore di portata con freno al 50%
- Deviatore con ritorno automatico

Cromo lucido	YO126100/ECR	139,00 €
Mora opaco	YO126100/EBM	208,00 €

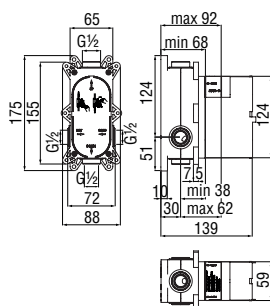
NR00212/13CR  
57,00 €**Easybox 2 vie, parte incasso necessaria**

- Ingresso e uscita acqua ø 1/2"
- Adatta anche a montaggio su cartongesso

Nota: disponibile il dispositivo antireflusso RVRENI717 (opzionale)

-	WE81100	135,00 €
---	---------	----------

CARTRIDGE  
WARRANTYRCR350  
39,00 €RVRENI717  
33,00 €

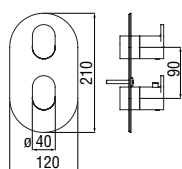

**Parte esterna termostatico a 1 via**

- Blocco di sicurezza 38° C
- Montaggio verticale o orizzontale

Cromo lucido	UP94101CR	379,00 €
Mora opaco	UP94101BM	570,00 €



NR00008  
34,00 €

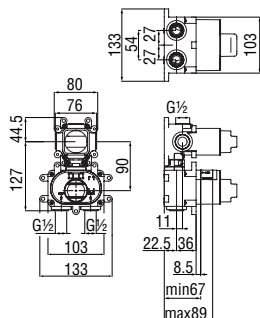

**Wellbox 1 via, parte incasso necessaria**

- Ingresso e uscita acqua ø 1/2"
- Rubinetti di chiusura
- Valvole antiritorno
- Adatta anche a montaggio su cartongesso
- Filtri di ricambio cartuccia inclusi nella confezione

-	WE00101	167,00 €
---	---------	----------



RCR201/5  
58,00 €



RVT200/5D  
18,00 €

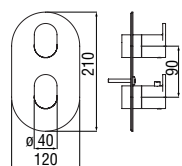

**Parte esterna termostatico a 2 vie**

- Blocco di sicurezza 38° C
- Montaggio verticale o orizzontale

Cromo lucido	UP94102CR	379,00 €
Mora opaco	UP94102BM	570,00 €



NR00008  
34,00 €

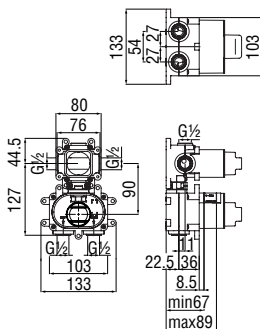

**Wellbox 2 vie, parte incasso necessaria**

- Ingresso e uscita acqua ø 1/2"
- Rubinetti di chiusura
- Valvole antiritorno
- Adatta anche a montaggio su cartongesso
- Filtri di ricambio cartuccia inclusi nella confezione

-	WE00102	215,00 €
---	---------	----------



RCR201/5  
58,00 €



RCR201/28  
39,00 €

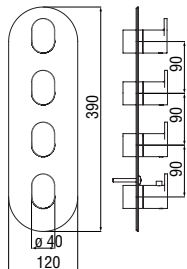

**Parte esterna termostatico a 3 vie**

- Blocco di sicurezza 38° C
- Montaggio verticale o orizzontale

Cromo lucido	UP94103CR	783,00 €
Mora opaco	UP94103BM	1.174,00 €



NR00008  
34,00 €

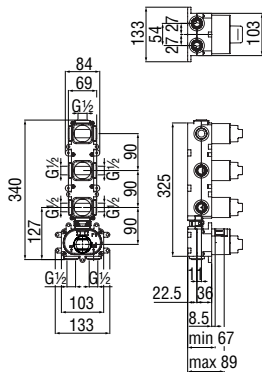

**Wellbox 3 vie, parte incasso necessaria**

- Ingresso e uscita acqua  $\varnothing$  1/2"
- Rubinetti di chiusura
- Valvole antiritorno
- Adatta anche a montaggio su cartongesso
- Filtri di ricambio cartuccia inclusi nella confezione

-	WE00103	318,00 €
---	---------	----------



RCR201/5  
58,00 €



RVT200/5D  
18,00 €

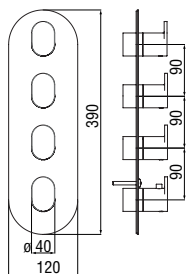

**Parte esterna termostatico a 4 vie**

- Blocco di sicurezza 38° C
- Montaggio verticale o orizzontale

Cromo lucido	UP94104CR	783,00 €
Mora opaco	UP94104BM	1.174,00 €



NR00008  
34,00 €

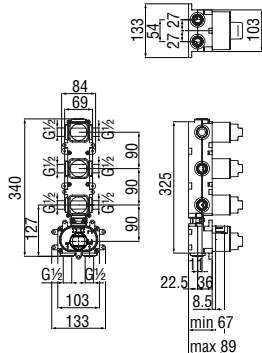

**Wellbox 4 vie, parte incasso necessaria**

- Ingresso e uscita acqua  $\varnothing$  1/2"
- Rubinetti di chiusura
- Valvole antiritorno
- Adatta anche a montaggio su cartongesso
- Filtri di ricambio cartuccia inclusi nella confezione

-	WE00104	360,00 €
---	---------	----------



RCR201/5  
58,00 €



RCR201/28  
39,00 €



RVT200/5D  
18,00 €



RUBINETTERIA NOBILI

# SEVEN

Meneghello Paoletti Associati

Linee rigorose alleggerite da profili sinuosi: una ricercatezza sofisticata che connette armoniosamente il mondo maschile e quello femminile. Essenziale, concreta, pragmatica, l'innovazione tecnologica si veste di un abito sofisticato ed elegante, pura espressione dell'avanguardia produttiva del nostro marchio.



Cromo lucido



Inox spazzolato

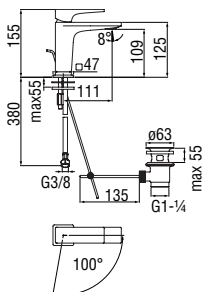

Mora opaco

**Monocomando a risparmio energetico**

- Limitatore di energia con apertura in acqua fredda
- Limitatore di portata con freno al 50%
- Aeratore anticalcare M 24 x 1, portata 5 l/min
- Scarico 1 1/4" con sistema brevettato SNAP
- Flessibili inox ø 3/8"

Cromo lucido	SEE124118/1CR	183,00 €
Inox spazzolato	SEE124118/1IX	<b>NEW</b> 274,00 €
Mora opaco	SEE124118/1BM	274,00 €



CARTRIDGE  
WARRANTY



RCR280/DECO  
50,00 €

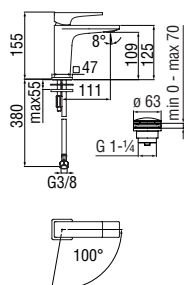

RAEK222/40  
56,00 € - 10 pz.

**Monocomando a risparmio energetico**

- Limitatore di energia con apertura in acqua fredda
- Limitatore di portata con freno al 50%
- Aeratore anticalcare M 24 x 1, portata 5 l/min
- Scarico 1 1/4" push
- Flessibili inox ø 3/8"

Cromo lucido	SEE124118/2CR	196,00 €
Inox spazzolato	SEE124118/2IX	<b>NEW</b> 294,00 €
Mora opaco	SEE124118/2BM	294,00 €



CARTRIDGE  
WARRANTY



RCR280/DECO  
50,00 €

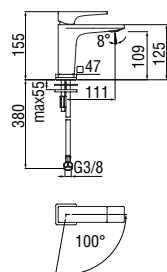

RAEK222/40  
56,00 € - 10 pz.

**Monocomando a risparmio energetico**

- Limitatore di energia con apertura in acqua fredda
- Limitatore di portata con freno al 50%
- Aeratore anticalcare M 24 x 1, portata 5 l/min
- Senza scarico
- Flessibili inox ø 3/8"

Cromo lucido	SEE124118/3CR	180,00 €
Inox spazzolato	SEE124118/3IX	<b>NEW</b> 270,00 €
Mora opaco	SEE124118/3BM	270,00 €



CARTRIDGE  
WARRANTY



RCR280/DECO  
50,00 €

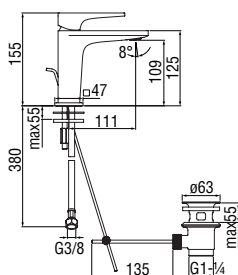

RAEK222/40  
56,00 € - 10 pz.

**Monocomando**

- Limitatore di portata con freno al 50%
- Aeratore anticalcare M 24 x 1, portata 5 l/min
- Scarico 1 1/4" con sistema brevettato SNAP
- Flessibili inox ø 3/8"

Cromo lucido	SE124118/1CR	182,00 €
Inox spazzolato	SE124118/1IX	<b>NEW</b> 272,00 €
Mora opaco	SE124118/1BM	272,00 €



CARTRIDGE  
WARRANTY



RCR280/D  
39,00 €

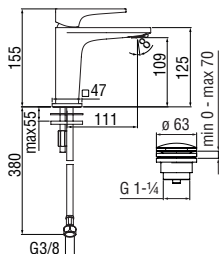

RAEK222/40  
56,00 € - 10 pz.

**Monocomando**

- Limitatore di portata con freno al 50%
- Aeratore anticalcare M 24 x 1, portata 5 l/min
- Scarico 1 1/4" push
- Flessibili inox  $\varnothing$  3/8"

Cromo lucido	SE124118/2CR	195,00 €
Inox spazzolato	SE124118/2IX	<b>NEW</b> 294,00 €
Mora opaco	SE124118/2BM	294,00 €



CARTRIDGE  
WARRANTY



RCR280/D  
39,00 €

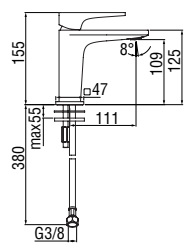

RAEK222/40  
56,00 € - 10 pz.

**Monocomando**

- Limitatore di portata con freno al 50%
- Aeratore anticalcare M 24 x 1, portata 5 l/min
- Senza scarico
- Flessibili inox  $\varnothing$  3/8"

Cromo lucido	SE124118/3CR	179,00 €
Inox spazzolato	SE124118/3IX	<b>NEW</b> 268,00 €
Mora opaco	SE124118/3BM	268,00 €



CARTRIDGE  
WARRANTY



RCR280/D  
39,00 €

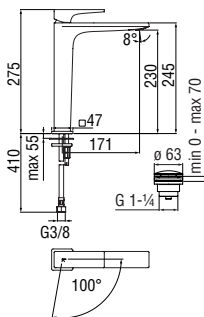

RAEK222/40  
56,00 € - 10 pz.

**Monocomando a bacinella a risparmio energetico**

- Limitatore di energia con apertura in acqua fredda
- Limitatore di portata con freno al 50%
- Aeratore anticalcare M 24 x 1, portata 5 l/min
- Scarico 1 1/4" push
- Flessibili inox  $\varnothing$  3/8"

Cromo lucido	SEE124128/2CR	368,00 €
Inox spazzolato	SEE124128/2IX	<b>NEW</b> 551,00 €
Mora opaco	SEE124128/2BM	551,00 €



CARTRIDGE  
WARRANTY



RCR280/DECO  
50,00 €

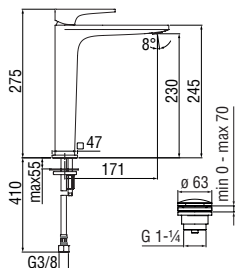

RAEK222/40  
56,00 € - 10 pz.

**Monocomando a bacinella**

- Limitatore di portata con freno al 50%
- Aeratore anticalcare M 24 x 1, portata 5 l/min
- Scarico 1 1/4" push
- Flessibili inox  $\varnothing$  3/8"

Cromo lucido	SE124128/2CR	366,00 €
Inox spazzolato	SE124128/2IX	<b>NEW</b> 549,00 €
Mora opaco	SE124128/2BM	549,00 €



CARTRIDGE  
WARRANTY



RCR280/D  
39,00 €

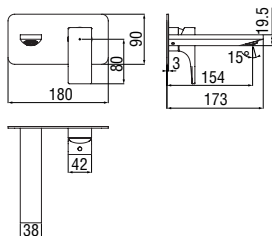

RAEK222/40  
56,00 € - 10 pz.

**Parte esterna monocomando a parete**

- Limitatore di portata con freno al 50%
- Aeratore anticalcare M 24 x 1, portata 5 l/min
- Lunghezza bocca 150 mm
- Senza scarico

Cromo lucido	SE124198CR	274,00 €
Inox spazzolato	SE124198IX	<b>NEW</b> 413,00 €
Mora opaco	SE124198BM	413,00 €



RAEK222/40  
56,00 € - 10 pz.

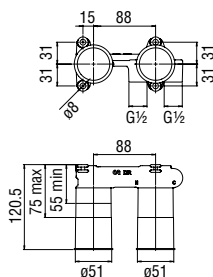

NR00212/10CR  
43,00 €

**Allbox, parte incasso necessaria**

- Ingresso acqua calda e acqua fredda ø 1/2"
- Uscita ø 1/2"

- WE00198 **MOD** 125,00 €



CARTRIDGE  
WARRANTY

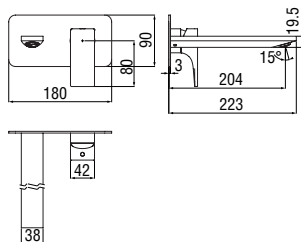

RCR350  
39,00 €

**Parte esterna monocomando a parete bocca lunga**

- Limitatore di portata con freno al 50%
- Aeratore anticalcare M 24 x 1, portata 5 l/min
- Lunghezza bocca 200 mm
- Senza scarico

Cromo lucido	SE124198/1CR	305,00 €
Inox spazzolato	SE124198/1IX	<b>NEW</b> 457,00 €
Mora opaco	SE124198/1BM	457,00 €



RAEK222/40  
56,00 € - 10 pz.

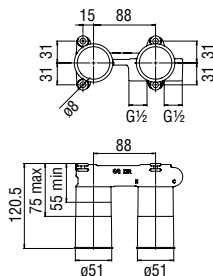

NR00212/10CR  
43,00 €

**Allbox, parte incasso necessaria**

- Ingresso acqua calda e acqua fredda ø 1/2"
- Uscita ø 1/2"

- WE00198 **MOD** 125,00 €



CARTRIDGE  
WARRANTY



RCR350  
39,00 €



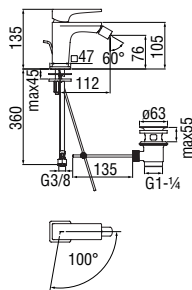

**Monocomando a risparmio energetico**

- Limitatore di energia con apertura in acqua fredda
- Limitatore di portata con freno al 50%
- Aeratore anticalcare M 16,5 x 1, portata 5 l/min
- Getto orientabile
- Scarico 1 1/4" con sistema brevettato SNAP
- Flessibili inox ø 3/8"

Cromo lucido	SEE124119/ICR	183,00 €
Inox spazzolato	SEE124119/1IX <b>NEW</b>	274,00 €
Mora opaco	SEE124119/1BM	274,00 €



CARTRIDGE WARRANTY



RCR280/DECO 50,00 €



RAE219/28CR 22,00 € - 1 pz.

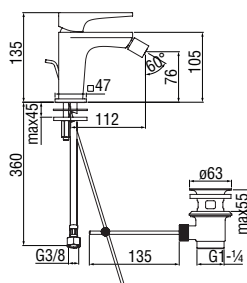

**Monocomando**

- Limitatore di portata con freno al 50%
- Aeratore anticalcare M 16,5 x 1, portata 5 l/min
- Getto orientabile
- Scarico 1 1/4" con sistema brevettato SNAP
- Flessibili inox ø 3/8"

Cromo lucido	SE124119/ICR	182,00 €
Inox spazzolato	SE124119/1IX <b>NEW</b>	272,00 €
Mora opaco	SE124119/1BM	272,00 €



CARTRIDGE WARRANTY



RCR280/D 39,00 €



RAE219/28CR 22,00 € - 1 pz.

**VASCA A PAVIMENTO**

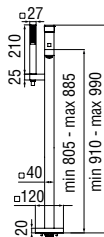
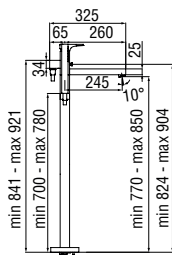
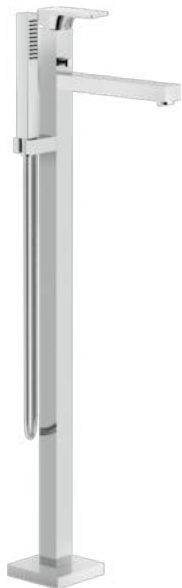

**Parte esterna monocomando a 2 vie**

- Limitatore di portata con freno al 50%
- Aeratore anticalcare M 28 x 1
- Deviatore con ritorno automatico
- Supporto doccetta fisso
- Doccetta monogetto e flessibile 150 cm

Cromo lucido	WE00180/SECR	1.555,00 €
Inox spazzolato	WE00180/SEIX	2.281,00 €
Mora opaco	WE00180/SEBM	2.281,00 €



CARTRIDGE WARRANTY



RCR350 39,00 €



RAEK219/41CR 47,00 € - 5 pz.

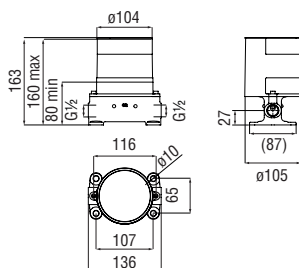

**Parte incasso necessaria**

- Ingresso acqua calda e acqua fredda ø 1/2"

-	WE77250 <b>MOD</b>	291,00 €
---	--------------------	----------

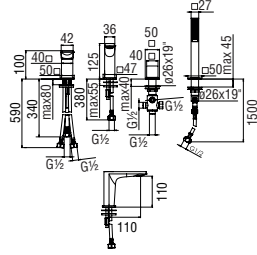

**Monocomando bordo vasca**

- Limitatore di portata con freno al 50%
- Aeratore anticalcare M 24 x 1
- Deviatore a 2 vie
- Doccetta monogetto estraibile

Cromo lucido	WEBK110/9SECR	1.101,00 €
Inox spazzolato	WEBK110/9SEIX <b>NEW</b>	1.598,00 €
Mora opaco	WEBK110/9SEBM	1.598,00 €



CARTRIDGE WARRANTY



RCR350 39,00 €



RAEK222/27 45,00 € - 10 pz.

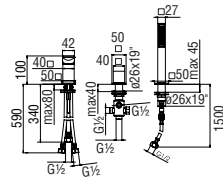

**Monocomando bordo vasca**

- Limitatore di portata con freno al 50%
- Deviatore a 2 vie
- Doccetta monogetto estraibile
- Erogazione dalla colonna vasca

Cromo lucido	WEBK110/6SECR	980,00 €
Inox spazzolato	WEBK110/6SEIX <b>NEW</b>	1.372,00 €
Mora opaco	WEBK110/6SEBM	1.372,00 €



CARTRIDGE WARRANTY



RCR350 39,00 €

VASCA

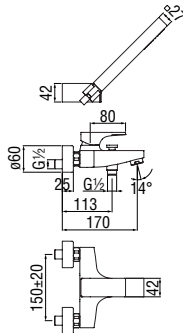

**Monocomando esterno con set doccia**

- Limitatore di portata con freno al 50%
- Aeratore anticalcare M 28 x 1
- Supporto doccetta orientabile
- Doccetta monogetto e flessibile 150 cm

Cromo lucido	SE124110CR	324,00 €
Inox spazzolato	SE124110IX <b>NEW</b>	486,00 €
Mora opaco	SE124110BM	486,00 €



CARTRIDGE WARRANTY



RCR340 39,00 €



RAEK219/41CR 47,00 € - 5 pz.

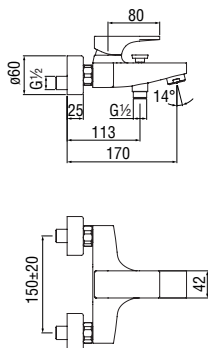

**Monocomando esterno**

- Limitatore di portata con freno al 50%
- Aeratore anticalcare M 28 x 1
- Uscita ø 1/2"

Cromo lucido	SE124110/1CR	230,00 €
Inox spazzolato	SE124110/1IX <b>NEW</b>	347,00 €
Mora opaco	SE124110/1BM	347,00 €



CARTRIDGE WARRANTY



RCR340 39,00 €

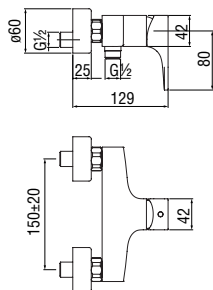

RAEK219/41CR 47,00 € - 5 pz.

**Monocomando esterno**

- Limitatore di portata con freno al 50%
- Uscita ø 1/2"

Cromo lucido	SE124130CR	186,00 €
Inox spazzolato	SE124130IX	<b>NEW</b> 280,00 €
Mora opaco	SE124130BM	280,00 €



CARTRIDGE  
WARRANTY

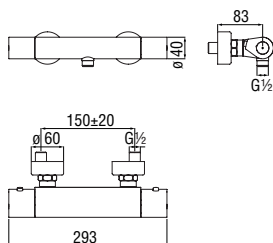

RCR350  
39,00 €

**Termostatico esterno**

- Blocco di sicurezza 38° C
- Valvole antiritorno
- Uscita ø 1/2"
- Filtri di ricambio cartuccia inclusi nella confezione

Cromo lucido	SE124030CR	218,00 €
Inox spazzolato	SE124030IX	<b>NEW</b> 328,00 €
Mora opaco	SE124030BM	328,00 €



RCR201/6  
58,00 €

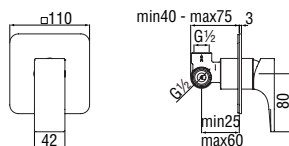

RVT200/26  
18,00 €

**Monocomando incasso a 1 via**

- Limitatore di portata con freno al 50%
- Ingresso acqua calda e acqua fredda ø 1/2"
- Uscita ø 1/2"
- Parte esterna e parte incasso

Cromo lucido	SE124108CR	109,00 €
Inox spazzolato	SE124108IX	<b>NEW</b> 164,00 €
Mora opaco	SE124108BM	164,00 €



CARTRIDGE  
WARRANTY



RCR350  
39,00 €

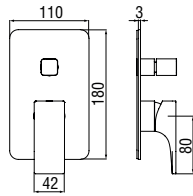

NR00212/10CR  
43,00 €

**Monocomando incasso a 2 vie**

- Limitatore di portata con freno al 50%
- Deviatore con ritorno automatico

Cromo lucido	SE124100/ECR	162,00 €
Inox spazzolato	SE124100/EIX	<b>NEW</b> 244,00 €
Mora opaco	SE124100/EBM	244,00 €

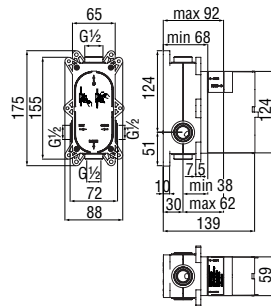

NR00212/13CR  
57,00 €

**Easybox 2 vie, parte incasso necessaria**

- Ingresso e uscita acqua  $\varnothing$  1/2"
- Adatta anche a montaggio su cartongesso

Nota: disponibile il dispositivo antireflusso RVREN1717 (opzionale)

-	WE81100	135,00 €
---	---------	----------



CARTRIDGE  
WARRANTY



RCR350  
39,00 €

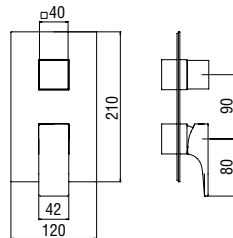

RVREN1717  
33,00 €

**Parte esterna monocomando incasso a 2-3 vie**

- Limitatore di portata con freno al 50%
- Tenuta o-ring invisibile
- Fissaggio a parete impermeabile

Cromo lucido	WE81102/SECR	398,00 €
Inox spazzolato	WE81102/SEIX	<b>NEW</b> 597,00 €
Mora opaco	WE81102/SEBM	597,00 €

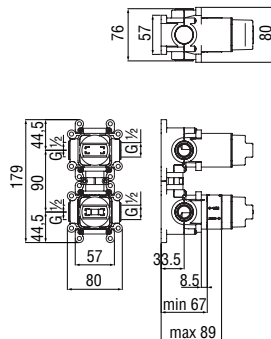
**Techbox 2 vie, parte incasso necessaria**

- Deviatore a 2 vie ceramico
- Ingresso e uscita acqua  $\varnothing$  1/2"
- Adatta anche a montaggio su cartongesso

-	WE81102	160,00 €
---	---------	----------



CARTRIDGE  
WARRANTY



RCR350  
39,00 €



RCR201/35FSC  
39,00 €

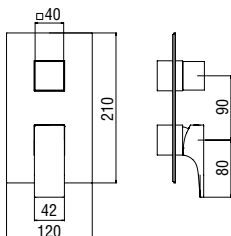

NR00212/30  
85,00 €

**Parte esterna monocomando incasso a 2-3 vie**

- Limitatore di portata con freno al 50%
- Tenuta o-ring invisibile
- Fissaggio a parete impermeabile

Cromo lucido	WE81102/SECR		398,00 €
Inox spazzolato	WE81102/SEIX	<b>NEW</b>	597,00 €
Mora opaco	WE81102/SEBM		597,00 €

**Techbox 3 vie, parte incasso necessaria**

- Deviatore a 3 vie ceramico
- Ingresso e uscita acqua  $\varnothing$  1/2"
- Adatta anche a montaggio su cartongesso

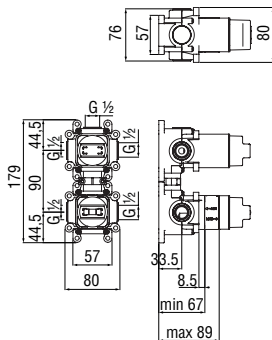

-	WE81103	184,00 €
---	---------	----------



CARTRIDGE  
WARRANTY



RCR350  
39,00 €



RCR201/35C  
39,00 €



NR00212/32  
85,00 €

## TERMOSTATICI INCASSO

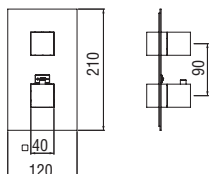
**Parte esterna termostatico a 1 via**

- Blocco di sicurezza 38° C
- Montaggio verticale o orizzontale

Cromo lucido	WE00101/QCR	519,00 €
Inox spazzolato	WE00101/QIX	779,00 €
Mora opaco	WE00101/QBM	779,00 €



NR00008  
34,00 €

**Wellbox 1 via, parte incasso necessaria**

- Ingresso e uscita acqua  $\varnothing$  1/2"
- Rubinetti di chiusura
- Valvole antiritorno
- Adatta anche a montaggio su cartongesso
- Filtri di ricambio cartuccia inclusi nella confezione

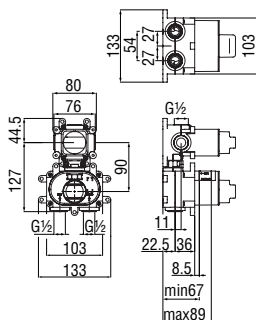

-	WE00101	167,00 €
---	---------	----------



RCR201/5  
58,00 €



RVT200/5D  
18,00 €

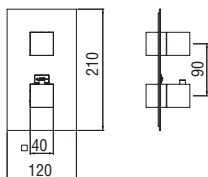

**Parte esterna termostatico a 2 vie**

- Blocco di sicurezza 38° C
- Montaggio verticale o orizzontale

Cromo lucido	WE00102/QCR	519,00 €
Inox spazzolato	WE00102/QIX	779,00 €
Mora opaco	WE00102/QBM	779,00 €

  
NR00008  
34,00 €

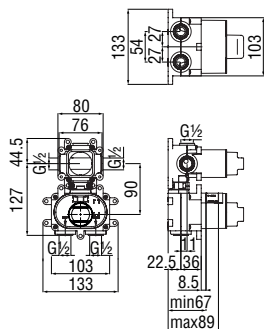

**Wellbox 2 vie, parte incasso necessaria**

- Ingresso e uscita acqua  $\varnothing$  1/2"
- Rubinetti di chiusura
- Valvole antiritorno
- Adatta anche a montaggio su cartongesso
- Filtri di ricambio cartuccia inclusi nella confezione

-	WE00102	215,00 €
---	---------	----------

  
RCR201/5  
58,00 €

  
RCR201/28  
39,00 €

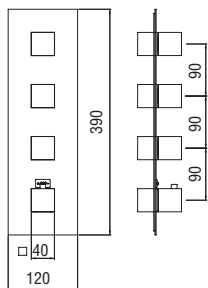

**Parte esterna termostatico a 3 vie**

- Blocco di sicurezza 38° C
- Montaggio verticale o orizzontale

Cromo lucido	WE00103/QCR	965,00 €
Inox spazzolato	WE00103/QIX	1.447,00 €
Mora opaco	WE00103/QBM	1.447,00 €

  
NR00008  
34,00 €

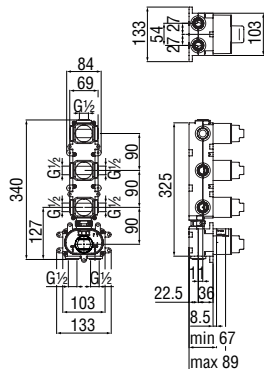

**Wellbox 3 vie, parte incasso necessaria**

- Ingresso e uscita acqua  $\varnothing$  1/2"
- Rubinetti di chiusura
- Valvole antiritorno
- Adatta anche a montaggio su cartongesso
- Filtri di ricambio cartuccia inclusi nella confezione

-	WE00103	318,00 €
---	---------	----------

  
RCR201/5  
58,00 €

  
RVT200/5D  
18,00 €

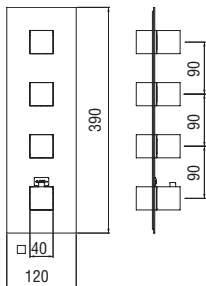

**Parte esterna termostatico a 4 vie**

- Blocco di sicurezza 38° C
- Montaggio verticale o orizzontale

Cromo lucido	WE00104/QCR	965,00 €
Inox spazzolato	WE00104/QIX	1.447,00 €
Mora opaco	WE00104/QBM	1.447,00 €

  
NR00008  
34,00 €

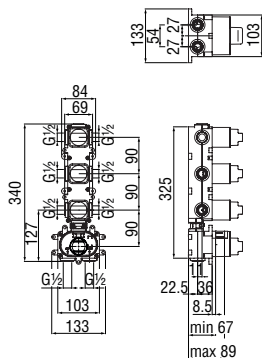

**Wellbox 4 vie, parte incasso necessaria**

- Ingresso e uscita acqua  $\varnothing$  1/2"
- Rubinetti di chiusura
- Valvole antiritorno
- Adatta anche a montaggio su cartongesso
- Filtri di ricambio cartuccia inclusi nella confezione

-	WE00104	360,00 €
---	---------	----------

  
RCR201/5  
58,00 €

  
RCR201/28  
39,00 €

  
RVT200/5D  
18,00 €





RUBINETTERIA NOBILI

# ACQUAVIVA

Centro Stile Nobili

Il fascino contemporaneo di una linea fresca ed attuale avvolge un'intensa tradizione tecnologica: Acquaviva celebra l'innovazione tecnologica maturata dal brand Nobili in oltre sessant'anni di esperienza attraverso uno stile moderno e accattivante, caratterizzato da linee ordinate e perfettamente equilibrate.



Cromo lucido

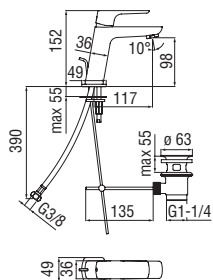

Mora opaco

**Monocomando**

- Limitatore di portata con freno al 50%
- Aeratore anticalcare M 24 x 1
- Scarico 1 1/4" con sistema brevettato SNAP
- Flessibili inox ø 3/8"

Cromo lucido	VV103118/1CR	158,00 €
Mora opaco	VV103118/1BM	236,00 €



CARTRIDGE  
WARRANTY



RCR280/D  
39,00 €

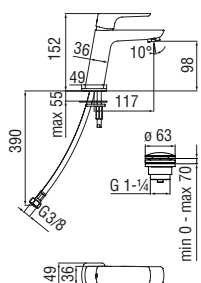

RAEK220/37CR  
47,00 € - 10 pz.

**Monocomando**

- Limitatore di portata con freno al 50%
- Aeratore anticalcare M 24 x 1
- Scarico 1 1/4" push
- Flessibili inox ø 3/8"

Cromo lucido	VV103118/2CR	171,00 €
Mora opaco	VV103118/2BM	257,00 €



CARTRIDGE  
WARRANTY



RCR280/D  
39,00 €

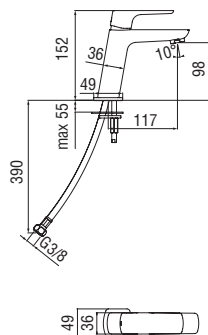

RAEK220/37CR  
47,00 € - 10 pz.

**Monocomando**

- Limitatore di portata con freno al 50%
- Aeratore anticalcare M 24 x 1
- Senza scarico
- Flessibili inox ø 3/8"

Cromo lucido	VV103118/3CR	154,00 €
Mora opaco	VV103118/3BM	232,00 €



CARTRIDGE  
WARRANTY



RCR280/D  
39,00 €

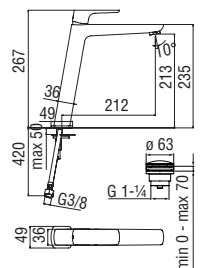

RAEK220/37CR  
47,00 € - 10 pz.

**Monocomando a bacinella**

- Limitatore di portata con freno al 50%
- Aeratore anticalcare M 24 x 1
- Scarico 1 1/4" push
- Flessibili inox ø 3/8"

Cromo lucido	VV103128/2CR	336,00 €
Mora opaco	VV103128/2BM	504,00 €



CARTRIDGE  
WARRANTY



RCR280/D  
39,00 €

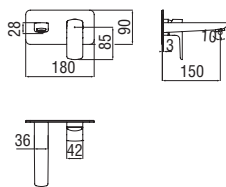

RAEK220/37CR  
47,00 € - 10 pz.

**Parte esterna monocomando a parete**

- Limitatore di portata con freno al 50%
- Aeratore anticalcare M 24 x 1
- Lunghezza bocca 150 mm
- Senza scarico

Cromo lucido	VV103198CR	250,00 €
Mora opaco	VV103198BM	375,00 €



RAEK220/37CR  
47,00 € - 10 pz.

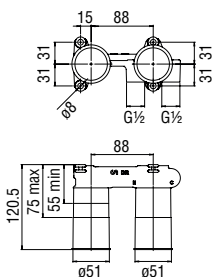

NR00212/10CR  
43,00 €

**Allbox, parte incasso necessaria**

- Ingresso acqua calda e acqua fredda ø 1/2"
- Uscita ø 1/2"

-	WE00198	<b>MOD</b>	125,00 €
---	---------	------------	----------



CARTRIDGE  
WARRANTY

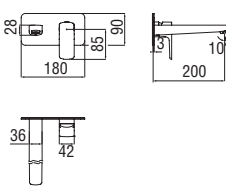

RCR350  
39,00 €

**Parte esterna monocomando a parete bocca lunga**

- Limitatore di portata con freno al 50%
- Aeratore anticalcare M 24 x 1
- Lunghezza bocca 200 mm
- Senza scarico

Cromo lucido	VV103198/1CR	277,00 €
Mora opaco	VV103198/1BM	415,00 €



RAEK220/37CR  
47,00 € - 10 pz.

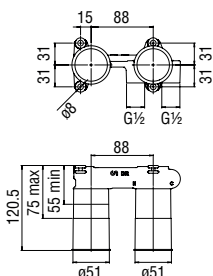

NR00212/10CR  
43,00 €

**Allbox, parte incasso necessaria**

- Ingresso acqua calda e acqua fredda ø 1/2"
- Uscita ø 1/2"

-	WE00198	<b>MOD</b>	125,00 €
---	---------	------------	----------



CARTRIDGE  
WARRANTY



RCR350  
39,00 €

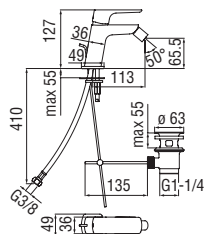

**Monocomando**

- Limitatore di portata con freno al 50%
- Aeratore anticalcare M 16,5 x 1
- Getto orientabile
- Scarico 1 1/4" con sistema brevettato SNAP
- Flessibili inox ø 3/8"

Cromo lucido	VV103119/1CR	158,00 €
Mora opaco	VV103119/1BM	236,00 €



CARTRIDGE  
WARRANTY



RCR280/D  
39,00 €



RAEK222/25CR  
21,00 € - 1 pz.

VASCA

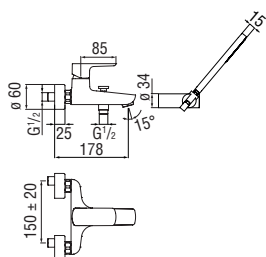

**Monocomando esterno con set doccia**

- Limitatore di portata con freno al 50%
- Aeratore anticalcare M 28 x 1
- Supporto doccetta orientabile
- Doccetta monogetto e flessibile 150 cm

Cromo lucido	VV103110CR	<b>MOD</b>	294,00 €
Mora opaco	VV103110BM	<b>MOD</b>	442,00 €



CARTRIDGE  
WARRANTY



RCR350/D  
39,00 €



RAEK219/41CR  
47,00 € - 5 pz.

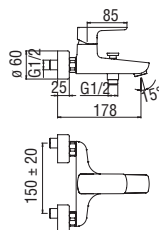

**Monocomando esterno**

- Limitatore di portata con freno al 50%
- Aeratore anticalcare M 28 x 1
- Uscita ø 1/2"

Cromo lucido	VV103110/1CR	210,00 €
Mora opaco	VV103110/1BM	315,00 €



CARTRIDGE  
WARRANTY



RCR350/D  
39,00 €



RAEK219/41CR  
47,00 € - 5 pz.

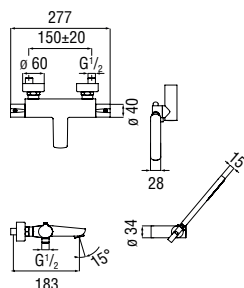

**Termostatico esterno con set doccia**

- Blocco di sicurezza 38° C
- Valvole antiritorno
- Aeratore anticalcare M 28 x 1
- Supporto doccetta orientabile
- Doccetta monogetto e flessibile 150 cm
- Filtri di ricambio cartuccia inclusi nella confezione

Cromo lucido	VV103010CR	<b>MOD</b>	329,00 €
Mora opaco	VV103010BM	<b>MOD</b>	492,00 €



RCR201/5  
58,00 €



RCR201/70  
39,00 €



RAEK219/41CR  
47,00 € - 5 pz.

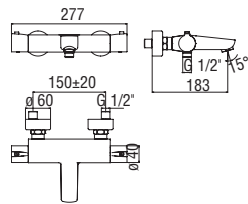

**Termostatico esterno**

- Blocco di sicurezza 38° C
- Valvoline antiritorno
- Aeratore anticalcare M 28 x 1
- Uscita ø 1/2"
- Filtri di ricambio cartuccia inclusi nella confezione

Cromo lucido	VV103010/1CR	244,00 €
Mora opaco	VV103010/1BM	365,00 €



RCR201/5  
58,00 €



RCR201/70  
39,00 €



RAEK219/41CR  
47,00 € - 5 pz.

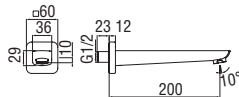

**Bocca a parete**

- Aeratore anticalcare M 24 x 1
- Lunghezza 200 mm

Cromo lucido	AV00158/40CR	191,00 €
Mora opaco	AV00158/40BM	287,00 €



RAEK220/14CR  
45,00 € - 10 pz.

DOCCIA

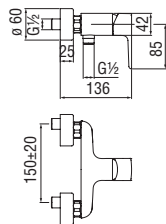

**Monocomando esterno**

- Limitatore di portata con freno al 50%
- Uscita ø 1/2"

Cromo lucido	VV103130CR	169,00 €
Mora opaco	VV103130BM	254,00 €



CARTRIDGE  
WARRANTY



RCR350  
39,00 €

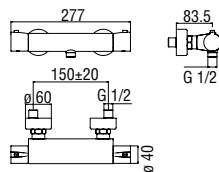

**Termostatico esterno**

- Blocco di sicurezza 38° C
- Valvoline antiritorno
- Uscita ø 1/2"
- Filtri di ricambio cartuccia inclusi nella confezione

Cromo lucido	VV103030CR	200,00 €
Mora opaco	VV103030BM	299,00 €



RCR201/6  
58,00 €

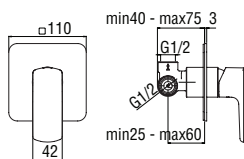

RVT200/26  
18,00 €

**Monocomando incasso a 1 via**

- Limitatore di portata con freno al 50%
- Ingresso acqua calda e acqua fredda  $\varnothing$  1/2"
- Uscita  $\varnothing$  1/2"
- Parte esterna e parte incasso

Cromo lucido	VV103108CR	100,00 €
Mora opaco	VV103108BM	149,00 €



CARTRIDGE  
WARRANTY



RCR350  
39,00 €

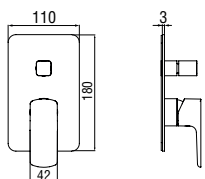

NR00212/10CR  
43,00 €

**Monocomando incasso a 2 vie**

- Limitatore di portata con freno al 50%
- Deviatore con ritorno automatico

Cromo lucido	VV103100/ECR	151,00 €
Mora opaco	VV103100/EBM	226,00 €

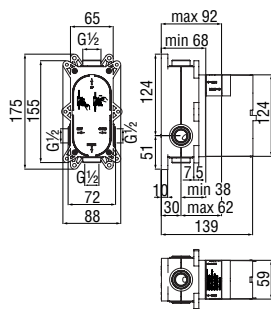

NR00212/13CR  
57,00 €

**Easybox 2 vie, parte incasso necessaria**

- Ingresso e uscita acqua  $\varnothing$  1/2"
- Adatta anche a montaggio su cartongesso

Nota: disponibile il dispositivo antireflusso RVREN1717 (opzionale)

-	WE81100	135,00 €
---	---------	----------



CARTRIDGE  
WARRANTY



RCR350  
39,00 €



RVREN1717  
33,00 €

RUBINETTERIA NOBILI

# LOOP

Piet Billekens

Quando la migliore tecnologia si dona all'estetica, scaturiscono realtà straordinarie: l'assoluto design di Loop è omaggio all'efficienza da cui discende. La nostra idea di perfezione raggiunge la meta più elevata: la cartuccia a immersione Nobili Widd® sintetizza in soli 28 millimetri di diametro il massimo della ricerca tecnologica.

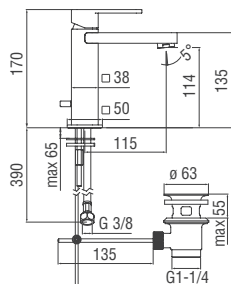

Cromo lucido

**Monocomando**

- Limitatore di portata con freno al 50%
- Aeratore anticalcare M 24 x 1
- Scarico 1 1/4" con sistema brevettato SNAP
- Flessibili inox  $\varnothing$  3/8"

Cromo lucido LP90118/1CR 370,00 €

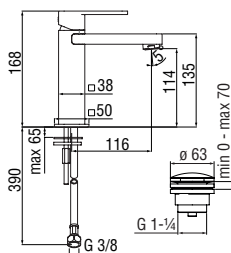
CARTRIDGE  
WARRANTYRCR280/D  
39,00 €RAEK220/37CR  
47,00 € - 10 pz.**Monocomando**

- Limitatore di portata con freno al 50%
- Aeratore anticalcare M 24 x 1
- Scarico 1 1/4" push
- Flessibili inox  $\varnothing$  3/8"

Cromo lucido LP90118/3CR 382,00 €

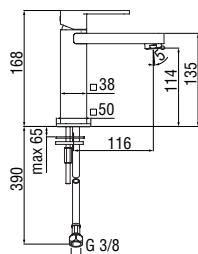
CARTRIDGE  
WARRANTYRCR280/D  
39,00 €RAEK220/37CR  
47,00 € - 10 pz.**Monocomando**

- Limitatore di portata con freno al 50%
- Aeratore anticalcare M 24 x 1
- Senza scarico
- Flessibili inox  $\varnothing$  3/8"

Cromo lucido LP90118/2CR 368,00 €

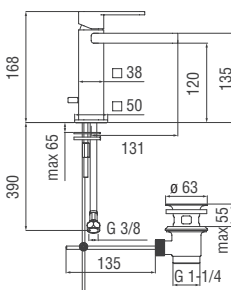
CARTRIDGE  
WARRANTYRCR280/D  
39,00 €RAEK220/37CR  
47,00 € - 10 pz.**Monocomando con bocca a cascata**

- Limitatore di portata con freno al 50%
- Scarico 1 1/4" con sistema brevettato SNAP
- Flessibili inox  $\varnothing$  3/8"

Cromo lucido LPC90118/1CR 440,00 €

CARTRIDGE  
WARRANTYRCR284/D  
39,00 €

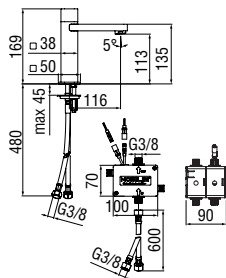

**Comando infrarossi**

- Aeratore anticalcare M 24 x 1
- Alimentazione a batteria
- Senza scarico
- Flessibili inox  $\varnothing$  3/8"

Cromo lucido

IRLP90118/3CR

501,00 €

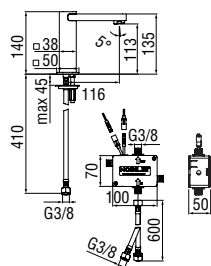

RAEK219/23CR  
61,00 € - 10 pz.

**Comando infrarossi monoacqua**

- Aeratore anticalcare M 24 x 1
- Alimentazione a batteria
- Senza scarico
- Flessibili inox  $\varnothing$  3/8"

Cromo lucido

IRLP90236CR

450,00 €

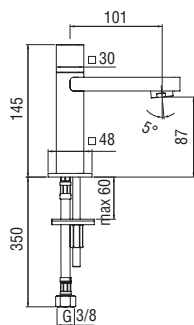

RAEK219/23CR  
61,00 € - 10 pz.

**Rubinetto monoacqua**

- Aeratore anticalcare M 24 x 1
- Senza scarico
- Flessibile inox  $\varnothing$  3/8"

Cromo lucido

LP90236CR

202,00 €



RVT200/5D  
18,00 €

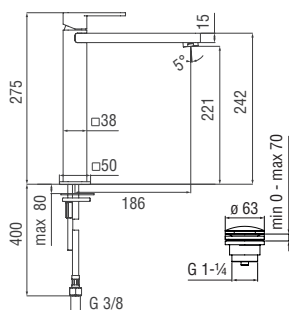

RAEK219/14CR  
58,00 € - 10 pz.

**Monocomando a bacinella**

- Limitatore di portata con freno al 50%
- Aeratore anticalcare M 24 x 1
- Scarico 1 1/4" push
- Flessibili inox  $\varnothing$  3/8"

Cromo lucido

LP90128/2CR

464,00 €



CARTRIDGE  
WARRANTY



RCR280/D  
39,00 €



RAEK220/37CR  
47,00 € - 10 pz.

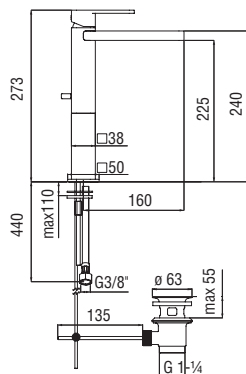

### Monocomando a bacinella con bocca a cascata

- Limitatore di portata con freno al 50%
- Scarico 1 1/4" con sistema brevettato SNAP
- Flessibili inox ø 3/8"

Cromo lucido LPC90128/1CR 501,00 €



CARTRIDGE  
WARRANTY



RCR284/D  
39,00 €

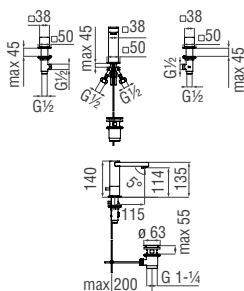

### Batteria 3 fori

- Aeratore anticalcare M 24 x 1
- Scarico 1 1/4" con sistema brevettato SNAP

Cromo lucido LP90211/1CR 552,00 €



RVT200/5D  
18,00 €



RAEK220/37CR  
47,00 € - 10 pz.

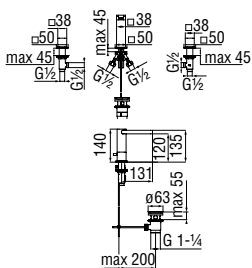

### Batteria 3 fori con bocca a cascata

- Scarico 1 1/4" con sistema brevettato SNAP

Cromo lucido LPC90211/1CR 589,00 €

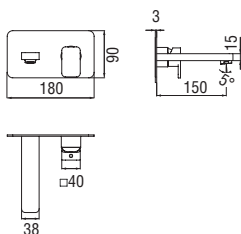

RVT200/5D  
18,00 €

**Parte esterna monocomando a parete**

- Limitatore di portata con freno al 50%
- Aeratore anticalcare M 24 x 1
- Lunghezza bocca 150 mm
- Senza scarico

Cromo lucido LP90198CR 446,00 €

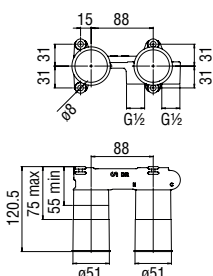
RAEK220/37CR  
47,00 € - 10 pz.NR00212/10CR  
43,00 €**Allbox, parte incasso necessaria**

- Ingresso acqua calda e acqua fredda  $\varnothing 1/2''$
- Uscita  $\varnothing 1/2''$

- WE00198 MOD 125,00 €

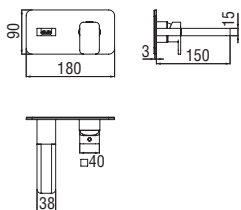
20 YEARS  
CARTRIDGE  
WARRANTYRCR350  
39,00 €**Parte esterna monocomando a parete bocca a cascata**

- Limitatore di portata con freno al 50%
- Lunghezza bocca 150 mm
- Senza scarico

Cromo lucido LPC90198CR 501,00 €

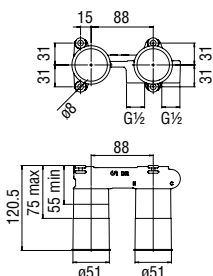
NR00212/10CR  
43,00 €**Allbox, parte incasso necessaria**

- Ingresso acqua calda e acqua fredda  $\varnothing 1/2''$
- Uscita  $\varnothing 1/2''$

- WE00198 MOD 125,00 €

20 YEARS  
CARTRIDGE  
WARRANTYRCR350  
39,00 €

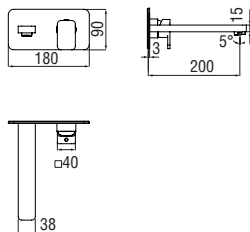
**Parte esterna monocomando a parete bocca lunga**

- Limitatore di portata con freno al 50%
- Aeratore anticalcare M 24 x 1
- Lunghezza bocca 200 mm
- Senza scarico

Cromo lucido LP90198/1CR 479,00 €

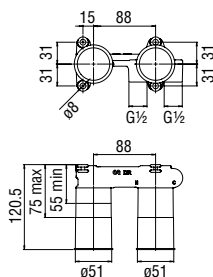
RAEK220/37CR  
47,00 € - 10 pz.NR00212/10CR  
43,00 €**Allbox, parte incasso necessaria**

- Ingresso acqua calda e acqua fredda ø 1/2"
- Uscita ø 1/2"

- WE00198 MOD 125,00 €

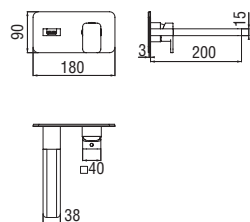
CARTRIDGE  
WARRANTYRCR350  
39,00 €**Parte esterna monocomando a parete bocca lunga a cascata**

- Limitatore di portata con freno al 50%
- Lunghezza bocca 200 mm
- Senza scarico

Cromo lucido LPC90198/1CR 528,00 €

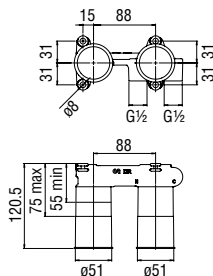
NR00212/10CR  
43,00 €**Allbox, parte incasso necessaria**

- Ingresso acqua calda e acqua fredda ø 1/2"
- Uscita ø 1/2"

- WE00198 MOD 125,00 €

CARTRIDGE  
WARRANTYRCR350  
39,00 €

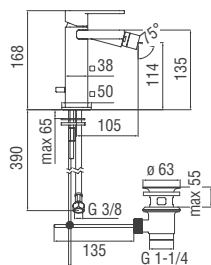

**Monocomando**

- Limitatore di portata con freno al 50%
- Aeratore anticalcare M 22 x 1
- Getto orientabile
- Scarico 1 1/4" con sistema brevettato SNAP
- Flessibili inox ø 3/8"

Cromo lucido LP90119/1CR 370,00 €



CARTRIDGE WARRANTY



RCR280/D 39,00 €



RAE219/61CR 23,00 € - 1 pz.

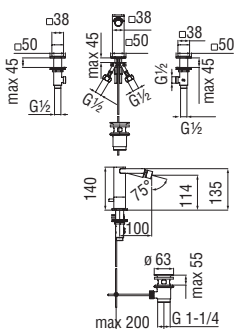

**Batteria 3 fori**

- Aeratore anticalcare M 22 x 1
- Getto orientabile
- Scarico 1 1/4" con sistema brevettato SNAP

Cromo lucido LP90215/1CR 552,00 €



RVT200/5D 18,00 €



RAE219/61CR 23,00 € - 1 pz.

VASCA A PAVIMENTO

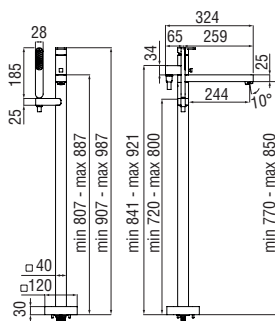

**Parte esterna monocomando a 2 vie**

- Limitatore di portata con freno al 50%
- Aeratore anticalcare M 28 x 1
- Deviatore con ritorno automatico
- Supporto doccetta fisso
- Doccetta monogetto e flessibile 150 cm

Cromo lucido LP90180CR **MOD** 1.408,00 €



CARTRIDGE WARRANTY



RCR350 39,00 €



RAEK219/41CR 47,00 € - 5 pz.

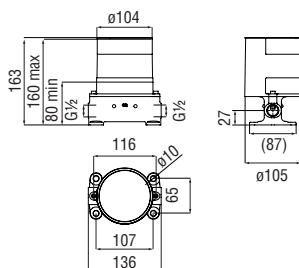

**Parte incasso necessaria**

- Ingresso acqua calda e acqua fredda ø 1/2"

- WE77250 **MOD** 291,00 €

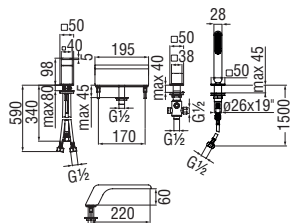

**Monocomando bordo vasca**

- Limitatore di portata con freno al 50%
- Bocca a cascata
- Deviatore a 2 vie
- Doccetta monogetto estraibile

Cromo lucido WEBK110/9LPCR MOD 1.559,00 €



CARTRIDGE WARRANTY



RCR350 39,00 €

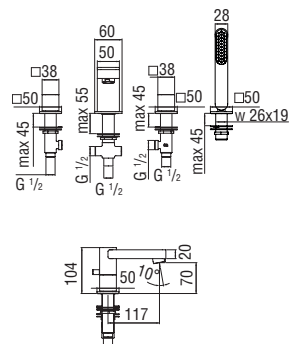

**Batteria 4 fori bordo vasca**

- Aeratore anticalcare M 28 x 1
- Deviatore con ritorno automatico
- Doccetta monogetto estraibile

Cromo lucido LP90001/6CR MOD 954,00 €



RVT200/5D 18,00 €



RAEK219/41CR 47,00 € - 5 pz.

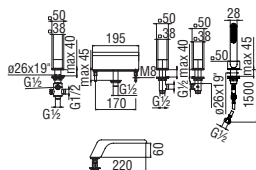

**Batteria 5 fori bordo vasca**

- Bocca a cascata
- Deviatore a 2 vie
- Doccetta monogetto estraibile

Cromo lucido WEBK204/LPCR MOD 1.377,00 €



RVT200/5D 18,00 €

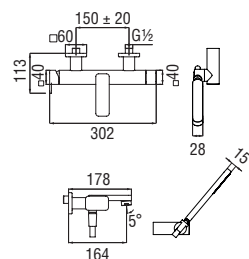

**Monocomando esterno con set doccia**

- Limitatore di portata con freno al 50%
- Aeratore anticalcare M 24 x 1
- Supporto doccetta orientabile
- Doccetta monogetto e flessibile 150 cm

Cromo lucido LP90110CR MOD 726,00 €



CARTRIDGE WARRANTY



RCR350 39,00 €



RCR201/59 51,00 €



RAEK220/14CR 45,00 € - 10 pz.

**Monocomando esterno**

- Limitatore di portata con freno al 50%
- Aeratore anticalcare M 24 x 1
- Uscita  $\varnothing$  1/2"

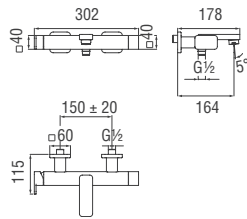

Cromo lucido LP90110/1CR 648,00 €



CARTRIDGE WARRANTY



RCR350 39,00 €



RCR201/59 51,00 €



RAEK220/14CR 45,00 € - 10 pz.

**Parte esterna monocomando incasso a 2 vie**

- Limitatore di portata con freno al 50%
- Deviatore a 2 vie
- Aeratore anticalcare M 28 x 1
- Supporto doccetta fisso
- Doccetta monogetto e flessibile 150 cm

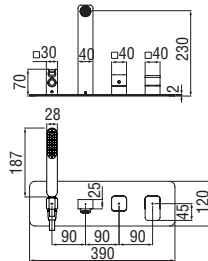

Cromo lucido WEBK110/90LPCR **MOD** 676,00 €



RAEK219/41CR 47,00 € - 5 pz.



NR00212/24CR 158,00 €

**Parte incasso necessaria**

- Ingresso acqua calda e acqua fredda  $\varnothing$  1/2"
- Uscite  $\varnothing$  1/2"

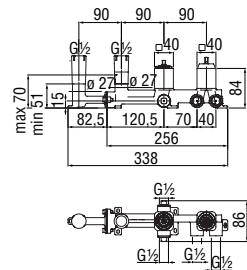

Cromo lucido WE81201/LPCR 442,00 €



CARTRIDGE WARRANTY



RCR350 39,00 €



RCR201/35FSC 39,00 €

**Bocca a parete**

- Aeratore anticalcare M 28 x 1
- Lunghezza 240 mm

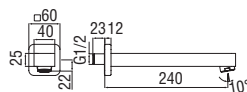

Cromo lucido AV00158/39CR 172,00 €



RAEK219/41CR 47,00 € - 5 pz.

**Monocomando esterno**

- Limitatore di portata con freno al 50%
- Uscita  $\varnothing$  1/2"

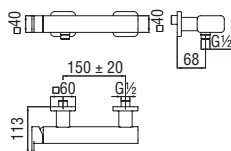

Cromo lucido LP90130CR 451,00 €

CARTRIDGE  
WARRANTYRCR350  
39,00 €**Monocomando incasso a 1 via**

- Limitatore di portata con freno al 50%
- Tenuta o-ring invisibile
- Fissaggio a parete impermeabile
- Ingresso acqua calda e acqua fredda  $\varnothing$  1/2"
- Uscita  $\varnothing$  1/2"
- Parte esterna e parte incasso

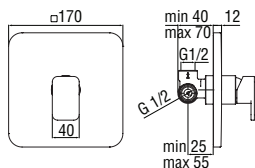

Cromo lucido LP90108CR 302,00 €

CARTRIDGE  
WARRANTYRCR350  
39,00 €NR00212/10CR  
43,00 €**Parte esterna monocomando incasso a 2 vie**

- Limitatore di portata con freno al 50%
- Deviatore con ritorno automatico
- Tenuta o-ring invisibile
- Fissaggio a parete impermeabile

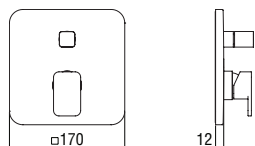

Cromo lucido LP90100/ECR 242,00 €

NR00212/13CR  
57,00 €**Easybox 2 vie, parte incasso necessaria**

- Ingresso e uscita acqua  $\varnothing$  1/2"
- Adatta anche a montaggio su cartongesso

Nota: disponibile il dispositivo antireflusso RVREN1717 (opzionale)

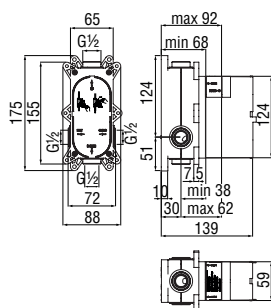

- WE81100 135,00 €

CARTRIDGE  
WARRANTYRCR350  
39,00 €RVREN1717  
33,00 €

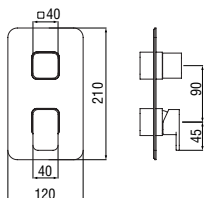

**Parte esterna monocomando incasso a 2-3 vie**

- Limitatore di portata con freno al 50%
- Tenuta o-ring invisibile
- Fissaggio a parete impermeabile

Cromo lucido

WE81102/LPCR

430,00 €

**Techbox 2 vie, parte incasso necessaria**

- Deviatore a 2 vie ceramico
- Ingresso e uscita acqua  $\varnothing 1/2''$
- Adatta anche a montaggio su cartongesso

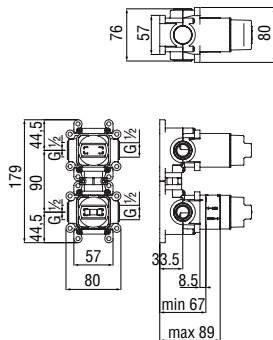

-

WE81102

160,00 €

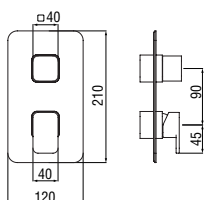
CARTRIDGE  
WARRANTYRCR350  
39,00 €RCR201/35FSC  
39,00 €NR00212/30  
85,00 €**Parte esterna monocomando incasso a 2-3 vie**

- Limitatore di portata con freno al 50%
- Tenuta o-ring invisibile
- Fissaggio a parete impermeabile

Cromo lucido

WE81102/LPCR

430,00 €

**Techbox 3 vie, parte incasso necessaria**

- Deviatore a 3 vie ceramico
- Ingresso e uscita acqua  $\varnothing 1/2''$
- Adatta anche a montaggio su cartongesso

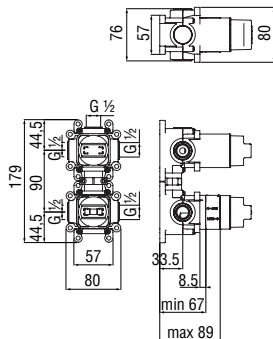

-

WE81103

184,00 €

CARTRIDGE  
WARRANTYRCR350  
39,00 €RCR201/35C  
39,00 €NR00212/32  
85,00 €

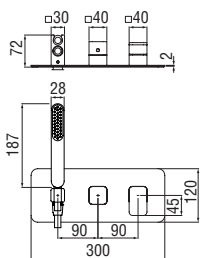
**Monocomando incasso a 2 vie**

- Limitatore di portata con freno al 50%
- Supporto doccetta fisso
- Doccetta monogetto e flessibile 150 cm
- Deviatore a 2 vie
- Abbinamento libero per la seconda via

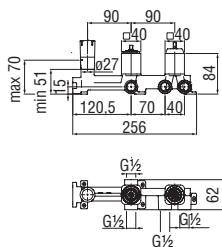
Cromo lucido WESK100/LPCR **MOD** 597,00 €NR00212/24CR  
158,00 €**Parte incasso necessaria**

- Ingresso acqua calda e acqua fredda ø 1/2"
- Uscite ø 1/2"

Cromo lucido WE81200/LPCR 390,00 €

CARTRIDGE  
WARRANTYRCR350  
39,00 €RCR201/35FSC  
39,00 €

## TERMOSTATICI INCASSO

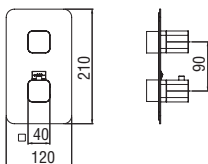
**Parte esterna termostatico a 1 via**

- Blocco di sicurezza 38° C
- Montaggio verticale o orizzontale

Cromo lucido LP90101CR 525,00 €

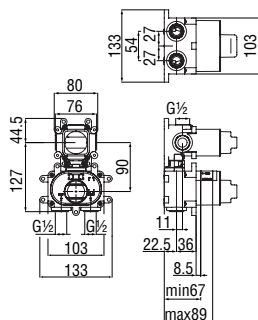
NR00008  
34,00 €**Wellbox 1 via, parte incasso necessaria**

- Ingresso e uscita acqua ø 1/2"
- Rubinetti di chiusura
- Valvole antiritorno
- Adatta anche a montaggio su cartongesso
- Filtri di ricambio cartuccia inclusi nella confezione

- WE00101 167,00 €

RCR201/5  
58,00 €RVT200/5D  
18,00 €

**Parte esterna termostatico a 2 vie**

- Blocco di sicurezza 38° C
- Montaggio verticale o orizzontale

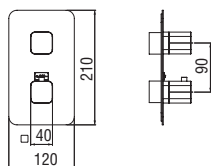

Cromo lucido LP90102CR 525,00 €



NR00008  
34,00 €

**Wellbox 2 vie, parte incasso necessaria**

- Ingresso e uscita acqua  $\varnothing$  1/2"
- Rubinetti di chiusura
- Valvole antiritorno
- Adatta anche a montaggio su cartongesso
- Filtri di ricambio cartuccia inclusi nella confezione

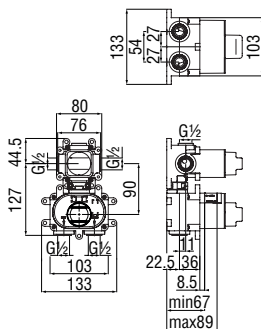

- WE00102 215,00 €



RCR201/5  
58,00 €



RCR201/28  
39,00 €

**Parte esterna termostatico a 3 vie**

- Blocco di sicurezza 38° C
- Montaggio verticale o orizzontale

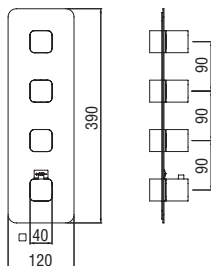

Cromo lucido LP90103CR 826,00 €



NR00008  
34,00 €

**Wellbox 3 vie, parte incasso necessaria**

- Ingresso e uscita acqua  $\varnothing$  1/2"
- Rubinetti di chiusura
- Valvole antiritorno
- Adatta anche a montaggio su cartongesso
- Filtri di ricambio cartuccia inclusi nella confezione

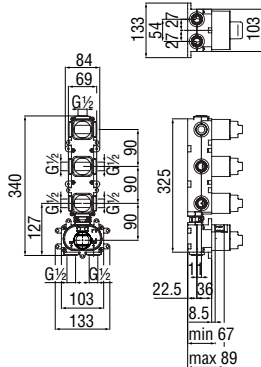

- WE00103 318,00 €



RCR201/5  
58,00 €



RVT200/5D  
18,00 €

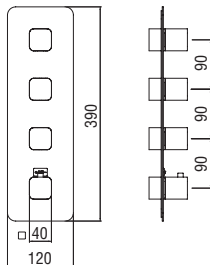

**Parte esterna termostatico a 4 vie**

- Blocco di sicurezza 38° C
- Montaggio verticale o orizzontale

Cromo lucido LP90104CR 826,00 €

NR00008  
34,00 €

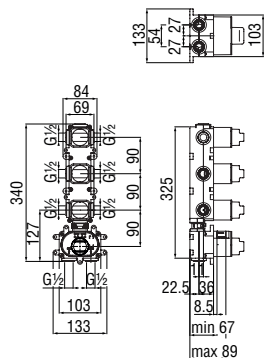

**Wellbox 4 vie, parte incasso necessaria**

- Ingresso e uscita acqua ø 1/2"
- Rubinetti di chiusura
- Valvole antiritorno
- Adatta anche a montaggio su cartongesso
- Filtri di ricambio cartuccia inclusi nella confezione

- WE00104 360,00 €

RCR201/5  
58,00 €

RCR201/28  
39,00 €

RVT200/5D  
18,00 €

RUBINETTERIA NOBILI

# UP

Centro Stile Nobili

Linee sfuggenti, sorprendente forza stilistica. Look fresco e giovanile, spirito distintivo. Up comunica entusiasmo e apre a nuove affascinanti visioni. Corpo leggero, carattere dinamico e anima innovativa: il portamento agile seduce con allegria, esaltando la personalità incisiva del miscelatore.



Cromo lucido

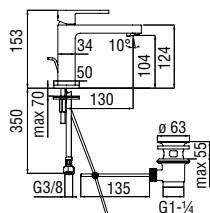

Mora opaco

**Monocomando**

- Limitatore di portata con freno al 50%
- Aeratore anticalcare M 24 x 1
- Scarico 1 1/4" con sistema brevettato SNAP
- Flessibili inox  $\varnothing$  3/8"

Cromo lucido	UP94118/1CR	245,00 €
Mora opaco	UP94118/1BM	368,00 €



CARTRIDGE  
WARRANTY



RCR280/D  
39,00 €

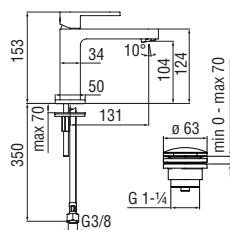

RAEK220/37CR  
47,00 € - 10 pz.

**Monocomando**

- Limitatore di portata con freno al 50%
- Aeratore anticalcare M 24 x 1
- Scarico 1 1/4" push
- Flessibili inox  $\varnothing$  3/8"

Cromo lucido	UP94118/3CR	258,00 €
Mora opaco	UP94118/3BM	389,00 €



CARTRIDGE  
WARRANTY



RCR280/D  
39,00 €

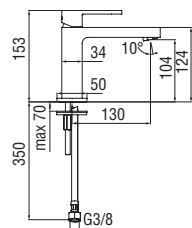

RAEK220/37CR  
47,00 € - 10 pz.

**Monocomando**

- Limitatore di portata con freno al 50%
- Aeratore anticalcare M 24 x 1
- Senza scarico
- Flessibili inox  $\varnothing$  3/8"

Cromo lucido	UP94118/2CR	242,00 €
Mora opaco	UP94118/2BM	362,00 €



CARTRIDGE  
WARRANTY



RCR280/D  
39,00 €

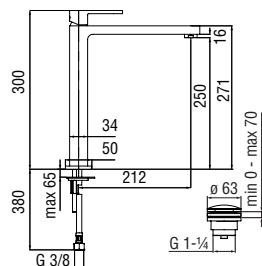

RAEK220/37CR  
47,00 € - 10 pz.

**Monocomando a bacinella**

- Limitatore di portata con freno al 50%
- Aeratore anticalcare M 24 x 1
- Scarico 1 1/4" push
- Flessibili inox  $\varnothing$  3/8"

Cromo lucido	UP94128/2CR	383,00 €
Mora opaco	UP94128/2BM	575,00 €



CARTRIDGE  
WARRANTY



RCR280/D  
39,00 €

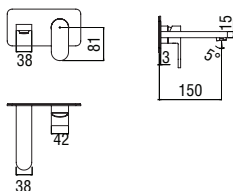

RAEK220/37CR  
47,00 € - 10 pz.

**Parte esterna monocomando a parete**

- Limitatore di portata con freno al 50%
- Aeratore anticalcare M 24 x 1
- Lunghezza bocca 150 mm
- Senza scarico

Cromo lucido	UP94198CR	246,00 €
Mora opaco	UP94198BM	369,00 €

 RAEK220/37CR  
47,00 € - 10 pz.

 NR00212/10CR  
43,00 €

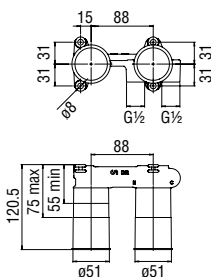
**Allbox, parte incasso necessaria**

- Ingresso acqua calda e acqua fredda  $\varnothing 1/2"$
- Uscita  $\varnothing 1/2"$

- WE00198 **MOD** 125,00 €

 20 YEARS  
CARTRIDGE  
WARRANTY

 RCR350  
39,00 €

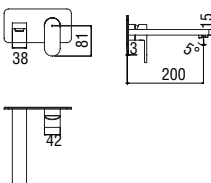
**Parte esterna monocomando a parete bocca lunga**

- Limitatore di portata con freno al 50%
- Aeratore anticalcare M 24 x 1
- Lunghezza bocca 200 mm
- Senza scarico

Cromo lucido	UP94198/1CR	272,00 €
Mora opaco	UP94198/1BM	410,00 €

 RAEK220/37CR  
47,00 € - 10 pz.

 NR00212/10CR  
43,00 €

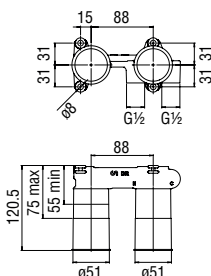
**Allbox, parte incasso necessaria**

- Ingresso acqua calda e acqua fredda  $\varnothing 1/2"$
- Uscita  $\varnothing 1/2"$

- WE00198 **MOD** 125,00 €

 20 YEARS  
CARTRIDGE  
WARRANTY

 RCR350  
39,00 €

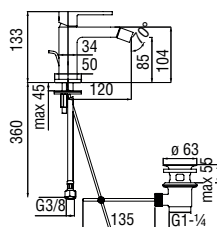
**Monocomando**

- Limitatore di portata con freno al 50%
- Aeratore anticalcare M 16,5 x 1
- Getto orientabile
- Scarico 1 1/4" con sistema brevettato SNAP
- Flessibili inox ø 3/8"

Cromo lucido	UP94119/1CR	245,00 €
Mora opaco	UP94119/1BM	368,00 €

 CARTRIDGE  
WARRANTY

 RCR280/D  
39,00 €

 RAE222/25CR  
21,00 € - 1 pz.

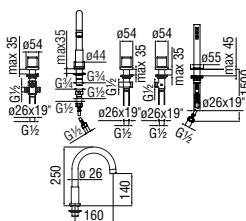
**BORDO VASCA**

**Batteria 5 fori bordo vasca**

- Aeratore anticalcare M 24 x 1
- Deviatore a 2 vie
- Doccetta monogetto estraibile

Cromo lucido	WEBK204/UPCR	649,00 €
Mora opaco	WEBK204/UPBM	963,00 €

 RVT200/5S  
18,00 €

 RVT200/5D  
18,00 €

 RAEK219/43CR  
38,00 € - 5 pz.

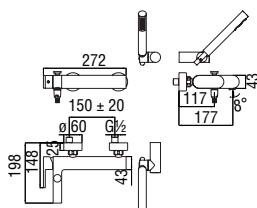
**VASCA**

**Monocomando esterno con set doccia**

- Limitatore di portata con freno al 50%
- Aeratore anticalcare M 24 x 1
- Deviatore con ritorno automatico
- Supporto doccetta orientabile
- Doccetta monogetto e flessibile 150 cm

Cromo lucido	UP94110CR	524,00 €
Mora opaco	UP94110BM	784,00 €



 CARTRIDGE  
WARRANTY

 RCR350/D  
39,00 €

 RAEK220/14CR  
45,00 € - 10 pz.

**Monocomando esterno**

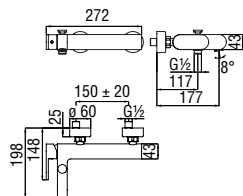
- Limitatore di portata con freno al 50%
- Aeratore anticalcare M 24 x 1
- Deviatore con ritorno automatico
- Uscita ø 1/2"



Cromo lucido	UP94110/1CR	463,00 €
Mora opaco	UP94110/1BM	695,00 €

 CARTRIDGE  
WARRANTY

 RCR350/D  
39,00 €

 RAEK220/14CR  
45,00 € - 10 pz.



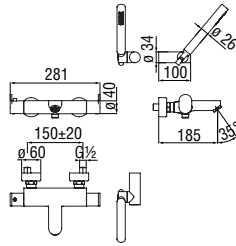

**Termostatico esterno con set doccia**

- Blocco di sicurezza 38° C
- Valvole antiritorno
- Aeratore anticalcare M 28 x 1
- Deviatore a 2 vie ceramico
- Doccetta monogetto, supporto orientabile e flessibile 150 cm
- Filtri di ricambio cartuccia inclusi nella confezione

Cromo lucido	UP94010CR	359,00 €
Mora opaco	UP94010BM	537,00 €



RCR201/5  
58,00 €



RCR201/70  
39,00 €



RAEK219/41CR  
47,00 € - 5 pz.

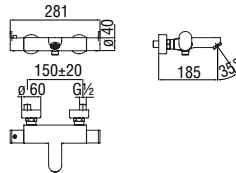

**Termostatico esterno**

- Blocco di sicurezza 38° C
- Valvole antiritorno
- Aeratore anticalcare M 28 x 1
- Deviatore a 2 vie ceramico
- Uscita ø 1/2"
- Filtri di ricambio cartuccia inclusi nella confezione

Cromo lucido	UP94010/1CR	331,00 €
Mora opaco	UP94010/1BM	497,00 €



RCR201/5  
58,00 €



RCR201/70  
39,00 €



RAEK219/41CR  
47,00 € - 5 pz.

DOCCIA

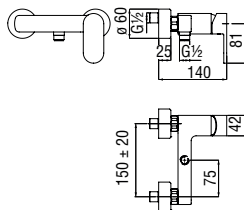

**Monocomando esterno**

- Limitatore di portata con freno al 50%
- Uscita ø 1/2"

Cromo lucido	UP94130CR	255,00 €
Mora opaco	UP94130BM	383,00 €



20 YEARS  
CARTRIDGE  
WARRANTY



RCR350/D  
39,00 €

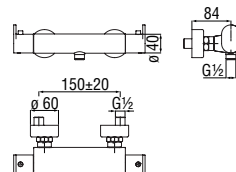

**Termostatico esterno**

- Blocco di sicurezza 38° C
- Valvole antiritorno
- Uscita ø 1/2"
- Filtri di ricambio cartuccia inclusi nella confezione

Cromo lucido	UP94030CR	245,00 €
Mora opaco	UP94030BM	368,00 €



RCR201/6  
58,00 €

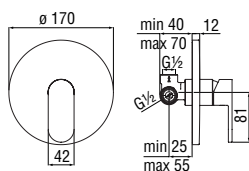

RVT200/26  
18,00 €

**Monocomando incasso a 1 via**

- Limitatore di portata con freno al 50%
- Tenuta o-ring invisibile
- Fissaggio a parete impermeabile
- Ingresso acqua calda e acqua fredda  $\varnothing$  1/2"
- Uscita  $\varnothing$  1/2"
- Parte esterna e parte incasso

Cromo lucido	UP94108CR	160,00 €
Mora opaco	UP94108BM	239,00 €



CARTRIDGE  
WARRANTY



RCR350  
39,00 €

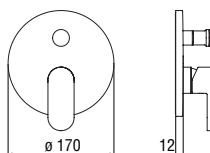

NR00212/10CR  
43,00 €

**Parte esterna monocomando incasso a 2 vie**

- Limitatore di portata con freno al 50%
- Deviatore con ritorno automatico
- Tenuta o-ring invisibile
- Fissaggio a parete impermeabile

Cromo lucido	UP94100/ECR	208,00 €
Mora opaco	UP94100/EBM	313,00 €

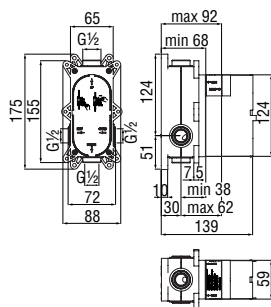

NR00212/13CR  
57,00 €

**Easybox 2 vie, parte incasso necessaria**

- Ingresso e uscita acqua  $\varnothing$  1/2"
- Adatta anche a montaggio su cartongesso

Nota: disponibile il dispositivo antireflusso RVREN1717 (opzionale)

-	WE81100	135,00 €
---	---------	----------



CARTRIDGE  
WARRANTY



RCR350  
39,00 €

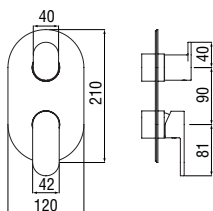

RVREN1717  
33,00 €

**Parte esterna monocomando incasso a 2-3 vie**

- Limitatore di portata con freno al 50%
- Tenuta o-ring invisibile
- Fissaggio a parete impermeabile

Cromo lucido	WE81102/UPCR	410,00 €
Mora opaco	WE81102/UPBM	615,00 €

**Techbox 2 vie, parte incasso necessaria**

- Deviatore a 2 vie ceramico
- Ingresso e uscita acqua  $\varnothing$  1/2"
- Adatta anche a montaggio su cartongesso

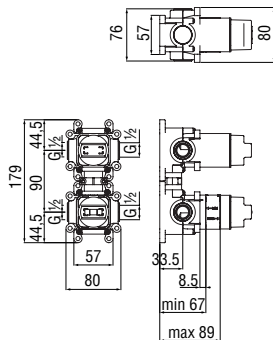

-	WE81102	160,00 €
---	---------	----------



CARTRIDGE  
WARRANTY



RCR350  
39,00 €



RCR201/35FSC  
39,00 €

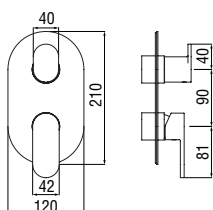

NR00212/30  
85,00 €

**Parte esterna monocomando incasso a 2-3 vie**

- Limitatore di portata con freno al 50%
- Tenuta o-ring invisibile
- Fissaggio a parete impermeabile

Cromo lucido	WE81102/UPCR	410,00 €
Mora opaco	WE81102/UPBM	615,00 €

**Techbox 3 vie, parte incasso necessaria**

- Deviatore a 3 vie ceramico
- Ingresso e uscita acqua  $\varnothing$  1/2"
- Adatta anche a montaggio su cartongesso

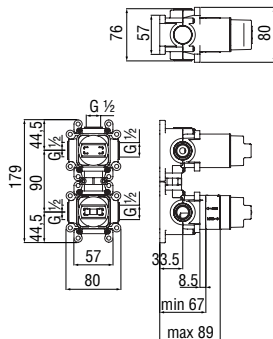

-	WE81103	184,00 €
---	---------	----------



CARTRIDGE  
WARRANTY



RCR350  
39,00 €



RCR201/35C  
39,00 €



NR00212/32  
85,00 €

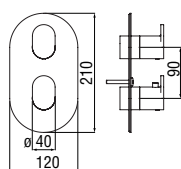

**Parte esterna termostatico a 1 via**

- Blocco di sicurezza 38° C
- Montaggio verticale o orizzontale

Cromo lucido	UP94101CR	379,00 €
Mora opaco	UP94101BM	570,00 €



NR00008  
34,00 €

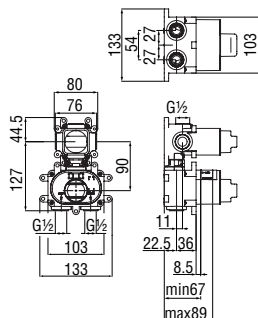

**Wellbox 1 via, parte incasso necessaria**

- Ingresso e uscita acqua ø 1/2"
- Rubinetti di chiusura
- Valvole antiritorno
- Adatta anche a montaggio su cartongesso
- Filtri di ricambio cartuccia inclusi nella confezione

-	WE00101	167,00 €
---	---------	----------



RCR201/5  
58,00 €



RVT200/5D  
18,00 €

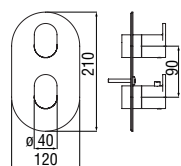

**Parte esterna termostatico a 2 vie**

- Blocco di sicurezza 38° C
- Montaggio verticale o orizzontale

Cromo lucido	UP94102CR	379,00 €
Mora opaco	UP94102BM	570,00 €



NR00008  
34,00 €

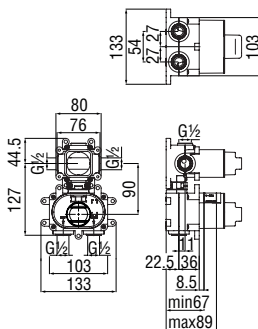

**Wellbox 2 vie, parte incasso necessaria**

- Ingresso e uscita acqua ø 1/2"
- Rubinetti di chiusura
- Valvole antiritorno
- Adatta anche a montaggio su cartongesso
- Filtri di ricambio cartuccia inclusi nella confezione

-	WE00102	215,00 €
---	---------	----------



RCR201/5  
58,00 €



RCR201/28  
39,00 €

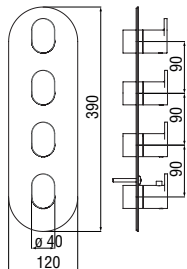

**Parte esterna termostatico a 3 vie**

- Blocco di sicurezza 38° C
- Montaggio verticale o orizzontale

Cromo lucido	UP94103CR	783,00 €
Mora opaco	UP94103BM	1.174,00 €

  
NR00008  
34,00 €

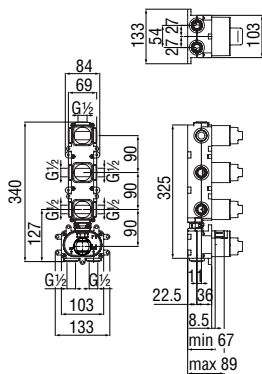

**Wellbox 3 vie, parte incasso necessaria**

- Ingresso e uscita acqua  $\varnothing$  1/2"
- Rubinetti di chiusura
- Valvoline antiritorno
- Adatta anche a montaggio su cartongesso
- Filtri di ricambio cartuccia inclusi nella confezione

-	WE00103	318,00 €
---	---------	----------

  
RCR201/5  
58,00 €

  
RVT200/5D  
18,00 €

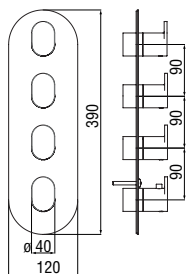

**Parte esterna termostatico a 4 vie**

- Blocco di sicurezza 38° C
- Montaggio verticale o orizzontale

Cromo lucido	UP94104CR	783,00 €
Mora opaco	UP94104BM	1.174,00 €

  
NR00008  
34,00 €

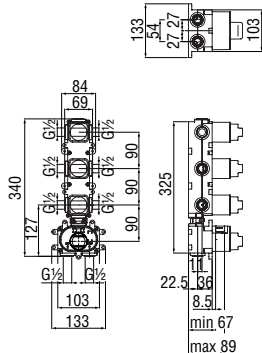

**Wellbox 4 vie, parte incasso necessaria**

- Ingresso e uscita acqua  $\varnothing$  1/2"
- Rubinetti di chiusura
- Valvoline antiritorno
- Adatta anche a montaggio su cartongesso
- Filtri di ricambio cartuccia inclusi nella confezione

-	WE00104	360,00 €
---	---------	----------

  
RCR201/5  
58,00 €

  
RCR201/28  
39,00 €

  
RVT200/5D  
18,00 €



RUBINETTERIA NOBILI

# RAY

Centro Stile Nobili

Il volume rigido del corpo si contrappone alle linee sensuali della bocca di miscelazione, dando vita a innovative proporzioni e giochi di forme. L'avanguardia tecnologica fissa nuovi standard di riferimento grazie alla lavorazione robotizzata su barra a sezione quadrata, in grado di disegnare forme taglienti e spigoli perfettamente precisi.

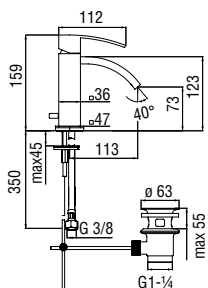

Cromo lucido

**Monocomando**

- Limitatore di portata con freno al 50%
- Aeratore anticalcare
- Scarico 1 1/4" con sistema brevettato SNAP
- Flessibili inox  $\varnothing$  3/8"

Cromo lucido RY00118/1CR 408,00 €

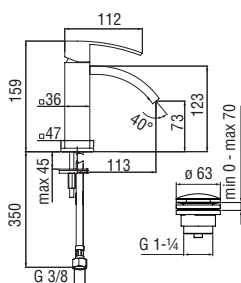
CARTRIDGE  
WARRANTYRCR280/D  
39,00 €RAEK222/28  
93,00 € - 5 pz.**Monocomando**

- Limitatore di portata con freno al 50%
- Aeratore anticalcare
- Scarico 1 1/4" push
- Flessibili inox  $\varnothing$  3/8"

Cromo lucido RY00118/2CR 421,00 €

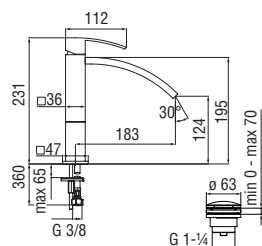
CARTRIDGE  
WARRANTYRCR280/D  
39,00 €RAEK222/28  
93,00 € - 5 pz.**Monocomando a bacinella**

- Limitatore di portata con freno al 50%
- Aeratore anticalcare
- Scarico 1 1/4" push
- Flessibili inox  $\varnothing$  3/8"

Cromo lucido RY00158/2CR 529,00 €

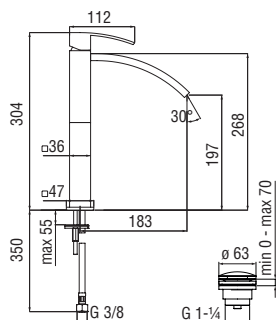
CARTRIDGE  
WARRANTYRCR280/D  
39,00 €RAEK222/28  
93,00 € - 5 pz.**Monocomando a bacinella**

- Limitatore di portata con freno al 50%
- Aeratore anticalcare
- Scarico 1 1/4" push
- Flessibili inox  $\varnothing$  3/8"

Cromo lucido RY00128/2CR 647,00 €

CARTRIDGE  
WARRANTYRCR280/D  
39,00 €RAEK222/28  
93,00 € - 5 pz.

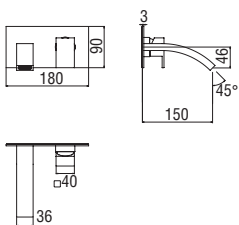

**Parte esterna monocomando a parete**

- Limitatore di portata con freno al 50%
- Aeratore anticalcare
- Lunghezza bocca 150 mm
- Senza scarico

Cromo lucido RY00198CR 537,00 €

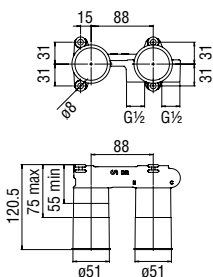
RAEK222/28  
93,00 € - 5 pz.NR00212/10CR  
43,00 €**Allbox, parte incasso necessaria**

- Ingresso acqua calda e acqua fredda  $\varnothing 1/2"$
- Uscita  $\varnothing 1/2"$

- WE00198 MOD 125,00 €

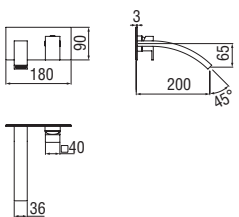
20 YEARS  
CARTRIDGE  
WARRANTYRCR350  
39,00 €**Parte esterna monocomando a parete bocca lunga**

- Limitatore di portata con freno al 50%
- Aeratore anticalcare
- Lunghezza bocca 200 mm
- Senza scarico

Cromo lucido RY00198/1CR 570,00 €

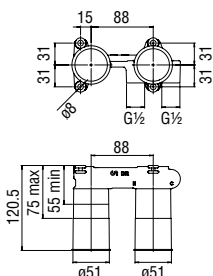
RAEK222/28  
93,00 € - 5 pz.NR00212/10CR  
43,00 €**Allbox, parte incasso necessaria**

- Ingresso acqua calda e acqua fredda  $\varnothing 1/2"$
- Uscita  $\varnothing 1/2"$

- WE00198 MOD 125,00 €

20 YEARS  
CARTRIDGE  
WARRANTYRCR350  
39,00 €

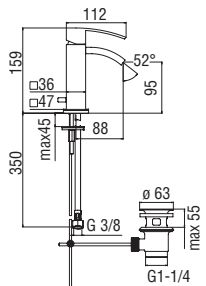

**Monocomando**

- Limitatore di portata con freno al 50%
- Aeratore anticalcare
- Scarico 1 1/4" con sistema brevettato SNAP
- Flessibili inox ø 3/8"

Cromo lucido RY00119/1CR 417,00 €



CARTRIDGE WARRANTY



RCR280/D 39,00 €



RAEK222/28 93,00 € - 5 pz.

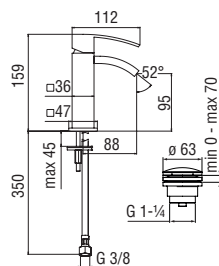

**Monocomando**

- Limitatore di portata con freno al 50%
- Aeratore anticalcare
- Scarico 1 1/4" push
- Flessibili inox ø 3/8"

Cromo lucido RY00119/2CR 431,00 €



CARTRIDGE WARRANTY



RCR280/D 39,00 €



RAEK222/28 93,00 € - 5 pz.

BORDO VASCA

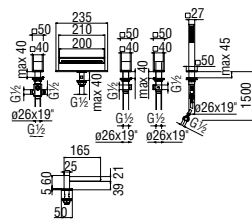

**Batteria 5 fori bordo vasca**

- Bocca a cascata
- Deviatore a 2 vie
- Doccetta monogetto estraibile

Cromo lucido WEBK204/QCR 1.557,00 €



RVT200/5D 18,00 €

VASCA

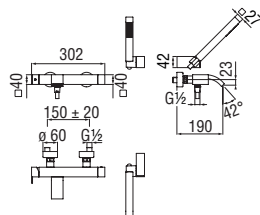

**Monocomando esterno con set doccia**

- Limitatore di portata con freno al 50%
- Aeratore anticalcare
- Supporto doccetta orientabile
- Doccetta monogetto e flessibile 150 cm

Cromo lucido RY00110CR 815,00 €



CARTRIDGE WARRANTY



RCR350 39,00 €



RCR201/59 51,00 €



RAEK219/27 96,00 € - 5 pz.

**Monocomando esterno**

- Limitatore di portata con freno al 50%
- Aeratore anticalcare
- Uscita ø 1/2"

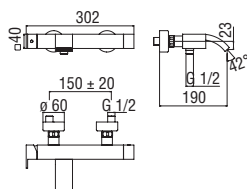

Cromo lucido RY00110/1CR 700,00 €



CARTRIDGE  
WARRANTY



RCR350  
39,00 €



RCR201/59  
51,00 €



RAEK219/27  
96,00 € - 5 pz.

**Termostatico esterno con set doccia**

- Blocco di sicurezza 38° C
- Valvole antiritorno
- Aeratore anticalcare
- Supporto doccetta orientabile
- Doccetta monogetto e flessibile 150 cm
- Filtri di ricambio cartuccia inclusi nella confezione

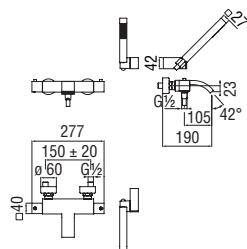

Cromo lucido RY00010CR 815,00 €



RCR201/5  
58,00 €



RCR201/70  
39,00 €



RAEK219/27  
96,00 € - 5 pz.

**Termostatico esterno**

- Blocco di sicurezza 38° C
- Valvole antiritorno
- Aeratore anticalcare
- Uscita ø 1/2"
- Filtri di ricambio cartuccia inclusi nella confezione

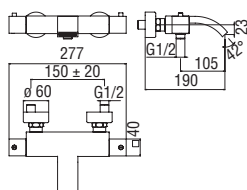

Cromo lucido RY00010/1CR 698,00 €



RCR201/5  
58,00 €



RCR201/70  
39,00 €



RAEK219/27  
96,00 € - 5 pz.

DOCCIA

**Monocomando esterno**

- Limitatore di portata con freno al 50%
- Uscita ø 1/2"

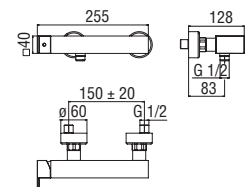

Cromo lucido RY00130CR 509,00 €



CARTRIDGE  
WARRANTY

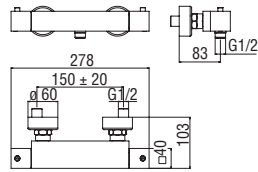

RCR350  
39,00 €

**Termostatico esterno**

- Blocco di sicurezza 38° C
- Valvole antiritorno
- Uscita ø 1/2"
- Filtri di ricambio cartuccia inclusi nella confezione

Cromo lucido RY00030CR 508,00 €

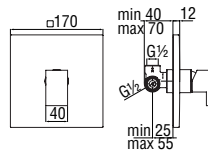
RCR201/5  
58,00 €RVT200/26  
18,00 €**Monocomando incasso a 1 via**

- Limitatore di portata con freno al 50%
- Tenuta o-ring invisibile
- Fissaggio a parete impermeabile
- Ingresso acqua calda e acqua fredda ø 1/2"
- Uscita ø 1/2"
- Parte esterna e parte incasso

Cromo lucido RY00108CR 372,00 €

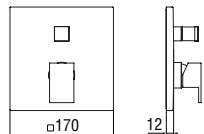
CARTRIDGE  
WARRANTYRCR350  
39,00 €NR00212/10CR  
43,00 €**Parte esterna monocomando incasso a 2 vie**

- Limitatore di portata con freno al 50%
- Deviatore con ritorno automatico
- Tenuta o-ring invisibile
- Fissaggio a parete impermeabile

Cromo lucido RY00100/ECR 318,00 €

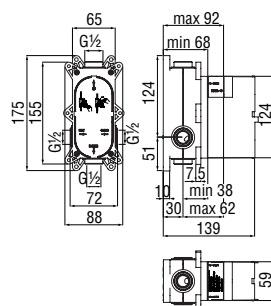
NR00212/13CR  
57,00 €**Easybox 2 vie, parte incasso necessaria**

- Ingresso e uscita acqua ø 1/2"
- Adatta anche a montaggio su cartongesso

Nota: disponibile il dispositivo antireflusso RVREN1717 (opzionale)

- WE81100 135,00 €

CARTRIDGE  
WARRANTYRCR350  
39,00 €RVREN1717  
33,00 €

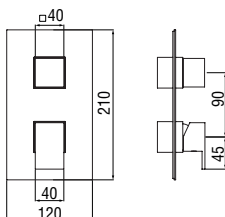
**Parte esterna monocomando incasso a 2-3 vie**

- Limitatore di portata con freno al 50%
- Tenuta o-ring invisibile
- Fissaggio a parete impermeabile

Cromo lucido

WE81102/QCR

420,00 €

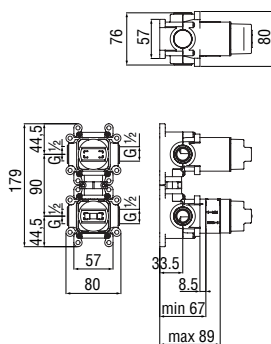
**Techbox 2 vie, parte incasso necessaria**

- Deviatore a 2 vie ceramico
- Ingresso e uscita acqua  $\varnothing$  1/2"
- Adatta anche a montaggio su cartongesso

-

WE81102

160,00 €

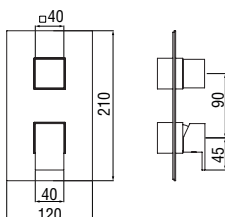
CARTRIDGE  
WARRANTYRCR350  
39,00 €RCR201/35FSC  
39,00 €NR00212/30  
85,00 €**Parte esterna monocomando incasso a 2-3 vie**

- Limitatore di portata con freno al 50%
- Tenuta o-ring invisibile
- Fissaggio a parete impermeabile

Cromo lucido

WE81102/QCR

420,00 €

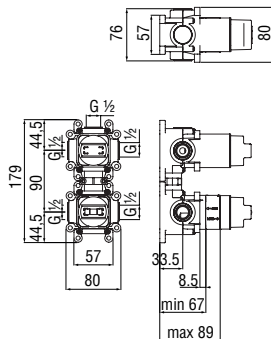
**Techbox 3 vie, parte incasso necessaria**

- Deviatore a 3 vie ceramico
- Ingresso e uscita acqua  $\varnothing$  1/2"
- Adatta anche a montaggio su cartongesso

-

WE81103

184,00 €

CARTRIDGE  
WARRANTYRCR350  
39,00 €RCR201/35C  
39,00 €NR00212/32  
85,00 €

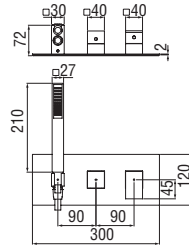
**Parte esterna monocomando incasso a 2 vie**

- Limitatore di portata con freno al 50%
- Supporto doccetta fisso
- Doccetta monogetto e flessibile 150 cm
- Deviatore a 2 vie
- Abbinamento libero per la seconda via

Cromo lucido

WESK100/QCR

670,00 €

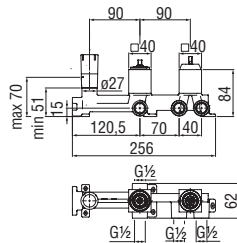
NR00212/23CR  
177,00 €

Cromo lucido

WE81200/QCR

390,00 €

20  
YEARS  
CARTRIDGE  
WARRANTYRCR350  
39,00 €RCR201/35FSC  
39,00 €

## TERMOSTATICI INCASSO

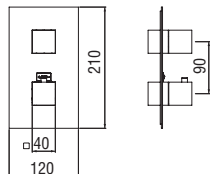
**Parte esterna termostatico a 1 via**

- Blocco di sicurezza 38° C
- Montaggio verticale o orizzontale

Cromo lucido

WE00101/QCR

519,00 €

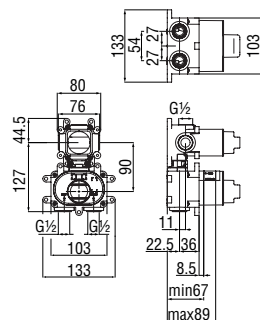
NR00008  
34,00 €**Wellbox 1 via, parte incasso necessaria**

- Ingresso e uscita acqua  $\varnothing$  1/2"
- Rubinetti di chiusura
- Valvole antiritorno
- Adatta anche a montaggio su cartongesso
- Filtri di ricambio cartuccia inclusi nella confezione

-

WE00101

167,00 €

RCR201/5  
58,00 €RVT200/5D  
18,00 €

**Parte esterna termostatico a 2 vie**

- Blocco di sicurezza 38° C
- Montaggio verticale o orizzontale

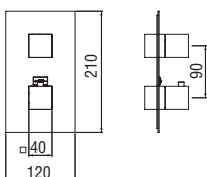

Cromo lucido WE00102/QCR 519,00 €



NR00008  
34,00 €

**Wellbox 2 vie, parte incasso necessaria**

- Ingresso e uscita acqua  $\varnothing$  1/2"
- Rubinetti di chiusura
- Valvole antiritorno
- Adatta anche a montaggio su cartongesso
- Filtri di ricambio cartuccia inclusi nella confezione

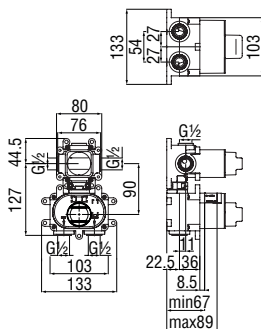

- WE00102 215,00 €



RCR201/5  
58,00 €



RCR201/28  
39,00 €

**Parte esterna termostatico a 3 vie**

- Blocco di sicurezza 38° C
- Montaggio verticale o orizzontale

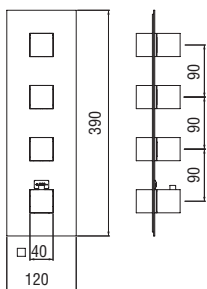

Cromo lucido WE00103/QCR 965,00 €



NR00008  
34,00 €

**Wellbox 3 vie, parte incasso necessaria**

- Ingresso e uscita acqua  $\varnothing$  1/2"
- Rubinetti di chiusura
- Valvole antiritorno
- Adatta anche a montaggio su cartongesso
- Filtri di ricambio cartuccia inclusi nella confezione

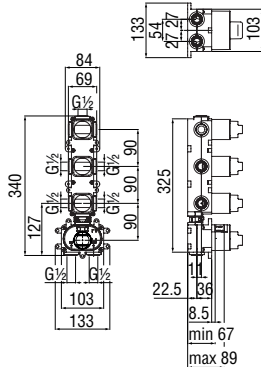

- WE00103 318,00 €



RCR201/5  
58,00 €



RVT200/5D  
18,00 €

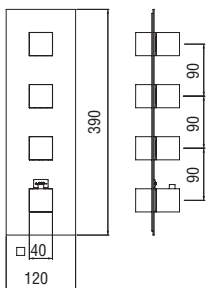

**Parte esterna termostatico a 4 vie**

- Blocco di sicurezza 38° C
- Montaggio verticale o orizzontale

Cromo lucido WE00104/QCR 965,00 €

 NR00008  
34,00 €

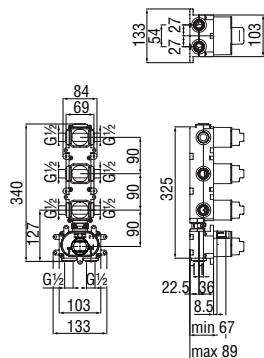

**Wellbox 4 vie, parte incasso necessaria**

- Ingresso e uscita acqua ø 1/2"
- Rubinetti di chiusura
- Valvole antiritorno
- Adatta anche a montaggio su cartongesso
- Filtri di ricambio cartuccia inclusi nella confezione

- WE00104 360,00 €

 RCR201/5  
58,00 €

 RCR201/28  
39,00 €

 RVT200/5D  
18,00 €



RUBINETTERIA NOBILI

# MIA

Centro Stile Nobili

Scelte estetiche limitate all'indispensabile. Eleganza e dinamismo. Freschezza e coerenza delle proporzioni. Evidente carattere, massima espressione di una bellezza senza tempo. Cartuccia Nobili Widd® dal diametro di soli 28 millimetri e lavorazione da barra, esclusivo connubio di prestigio tecnologico e avanguardia produttiva.



Cromo lucido



Inox spazzolato

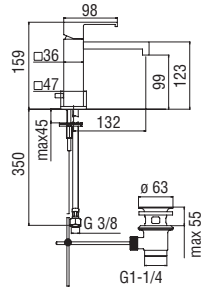

Mora opaco

**Monocomando**

- Limitatore di portata con freno al 50%
- Aeratore anticalcare
- Scarico 1 1/4" con sistema brevettato SNAP
- Flessibili inox  $\varnothing$  3/8"

Cromo lucido	MII02118/1CR	355,00 €
Inox spazzolato	MII02118/1IX	533,00 €
Mora opaco	MII02118/1BM	533,00 €



CARTRIDGE  
WARRANTY



RCR280/D  
39,00 €

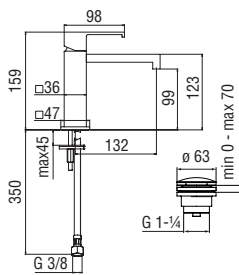

RAEK222/28  
93,00 € - 5 pz.

**Monocomando**

- Limitatore di portata con freno al 50%
- Aeratore anticalcare
- Scarico 1 1/4" push
- Flessibili inox  $\varnothing$  3/8"

Cromo lucido	MII02118/2CR	369,00 €
Inox spazzolato	MII02118/2IX	552,00 €
Mora opaco	MII02118/2BM	552,00 €



CARTRIDGE  
WARRANTY



RCR280/D  
39,00 €

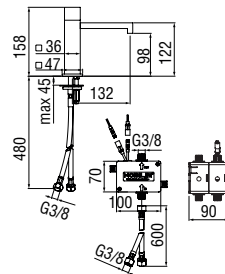

RAEK222/28  
93,00 € - 5 pz.

**Comando infrarossi**

- Aeratore anticalcare
- Alimentazione a batteria
- Senza scarico
- Flessibili inox  $\varnothing$  3/8"

Cromo lucido	IRMII02118/3CR	561,00 €
--------------	----------------	----------

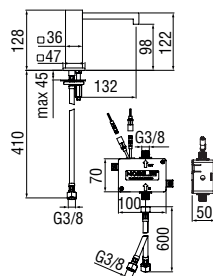

RAEK222/28  
93,00 € - 5 pz.

**Comando infrarossi monoacqua**

- Aeratore anticalcare
- Alimentazione a batteria
- Senza scarico
- Flessibili inox  $\varnothing$  3/8"

Cromo lucido	IRMII02236CR	509,00 €
--------------	--------------	----------



RAEK222/28  
93,00 € - 5 pz.

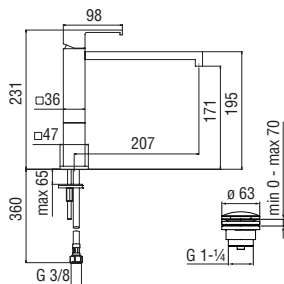

**Monocomando a bacinella**

- Limitatore di portata con freno al 50%
- Aeratore anticalcare
- Scarico 1 1/4" push
- Flessibili inox ø 3/8"

Cromo lucido	MI102158/2CR	465,00 €
Inox spazzolato	MI102158/2IX	698,00 €
Mora opaco	MI102158/2BM	698,00 €



CARTRIDGE  
WARRANTY



RCR280/D  
39,00 €



RAEK222/28  
93,00 € - 5 pz.

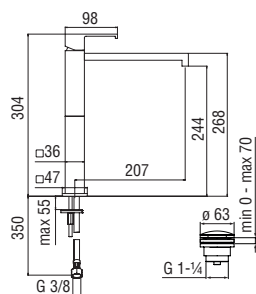

**Monocomando a bacinella**

- Limitatore di portata con freno al 50%
- Aeratore anticalcare
- Scarico 1 1/4" push
- Flessibili inox ø 3/8"

Cromo lucido	MI102128/2CR	580,00 €
Inox spazzolato	MI102128/2IX	872,00 €
Mora opaco	MI102128/2BM	872,00 €



CARTRIDGE  
WARRANTY



RCR280/D  
39,00 €



RAEK222/28  
93,00 € - 5 pz.

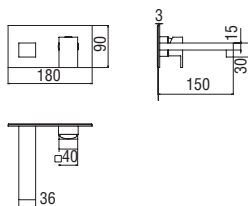

**Parte esterna monocomando a parete**

- Limitatore di portata con freno al 50%
- Aeratore anticalcare
- Lunghezza bocca 150 mm
- Senza scarico

Cromo lucido	MI102198CR	559,00 €
Inox spazzolato	MI102198IX	839,00 €
Mora opaco	MI102198BM	839,00 €



RAEK222/28  
93,00 € - 5 pz.



NR00212/10CR  
43,00 €

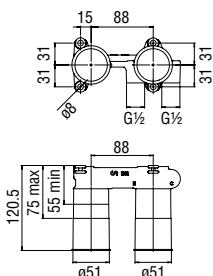

**Allbox, parte incasso necessaria**

- Ingresso acqua calda e acqua fredda ø 1/2"
- Uscita ø 1/2"

-	WE00198	<b>MOD</b>	125,00 €
---	---------	------------	----------



CARTRIDGE  
WARRANTY

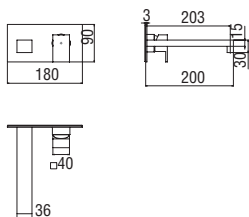

RCR350  
39,00 €

**Parte esterna monocomando a parete bocca lunga**

- Limitatore di portata con freno al 50%
- Aeratore anticalcare
- Lunghezza bocca 200 mm
- Senza scarico

Cromo lucido	MII02198/1CR	593,00 €
Inox spazzolato	MII02198/1IX	889,00 €
Mora opaco	MII02198/1BM	889,00 €



RAEK222/28  
93,00 € - 5 pz.

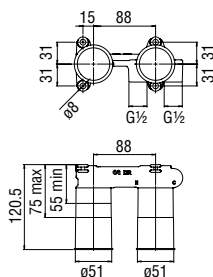

NR00212/10CR  
43,00 €

**Allbox, parte incasso necessaria**

- Ingresso acqua calda e acqua fredda  $\varnothing$  1/2"
- Uscita  $\varnothing$  1/2"

- WE00198 **MOD** 125,00 €



CARTRIDGE  
WARRANTY



RCR350  
39,00 €

## BIDET

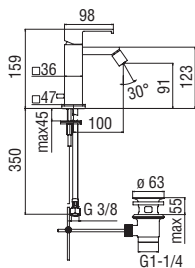
**Monocomando**

- Limitatore di portata con freno al 50%
- Aeratore anticalcare M 16 x 1
- Getto orientabile
- Scarico 1 1/4" con sistema brevettato SNAP
- Flessibili inox  $\varnothing$  3/8"

Cromo lucido	MII02119/1CR	373,00 €
Inox spazzolato	MII02119/1IX	559,00 €
Mora opaco	MII02119/1BM	559,00 €



CARTRIDGE  
WARRANTY



RCR280/D  
39,00 €

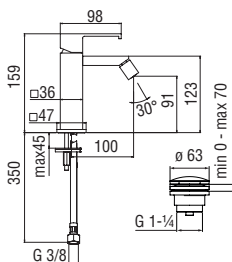

RAE222/25CR  
21,00 € - 1 pz.

**Monocomando**

- Limitatore di portata con freno al 50%
- Aeratore anticalcare M 16 x 1
- Getto orientabile
- Scarico 1 1/4" push
- Flessibili inox  $\varnothing$  3/8"

Cromo lucido	MII02119/2CR	386,00 €
Inox spazzolato	MII02119/2IX	579,00 €
Mora opaco	MII02119/2BM	579,00 €



CARTRIDGE  
WARRANTY



RCR280/D  
39,00 €



RAE222/25CR  
21,00 € - 1 pz.

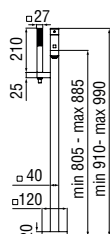
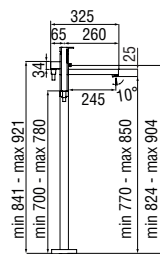
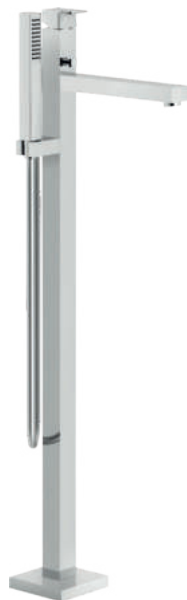

**Parte esterna monocomando a 2 vie**

- Limitatore di portata con freno al 50%
- Aeratore anticalcare M 28 x 1
- Deviatore con ritorno automatico
- Supporto doccetta fisso
- Doccetta monogetto e flessibile 150 cm

Cromo lucido	WE00180/QCR	1.665,00 €
Inox spazzolato	WE00180/QIX	2.498,00 €
Mora opaco	WE00180/QBM	2.498,00 €



CARTRIDGE  
WARRANTY



RCR350  
39,00 €



RAEK219/41CR  
47,00 € - 5 pz.

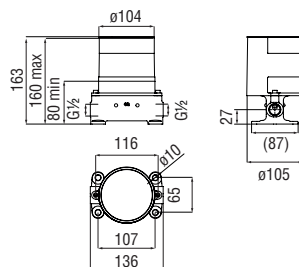

**Parte incasso necessaria**

- Ingresso acqua calda e acqua fredda  $\varnothing 1/2"$

-	WE77250	<b>MOD</b>	291,00 €
---	---------	------------	----------

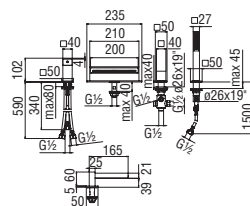

**Monocomando bordo vasca**

- Limitatore di portata con freno al 50%
- Bocca a cascata
- Deviatore a 2 vie
- Doccetta monogetto estraibile

Cromo lucido	WEBK110/9QCR	1.715,00 €
Inox spazzolato	WEBK110/9QIX	2.573,00 €
Mora opaco	WEBK110/9QBM	2.573,00 €



CARTRIDGE  
WARRANTY



RCR350  
39,00 €

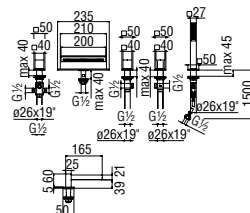

**Batteria 5 fori bordo vasca**

- Bocca a cascata
- Deviatore a 2 vie
- Doccetta monogetto estraibile

Cromo lucido	WEBK204/QCR	1.557,00 €
Inox spazzolato	WEBK204/QIX	2.336,00 €
Mora opaco	WEBK204/QBM	2.336,00 €



RVT200/5D  
18,00 €

**Monocomando esterno con set doccia**

- Limitatore di portata con freno al 50%
- Aeratore anticalcare M 24 x 1
- Supporto doccetta orientabile
- Doccetta monogetto e flessibile 150 cm

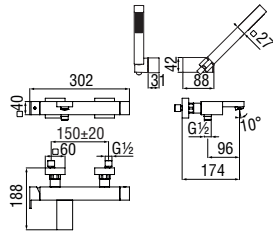

Cromo lucido	MQ102110CR	847,00 €
Inox spazzolato	MQ102110IX	1.273,00 €
Mora opaco	MQ102110BM	1.273,00 €



CARTRIDGE WARRANTY



RCR350  
39,00 €



RCR201/59  
51,00 €



RAEK220/14CR  
45,00 € - 10 pz.

**Monocomando esterno**

- Limitatore di portata con freno al 50%
- Aeratore anticalcare M 24 x 1
- Uscita ø 1/2"

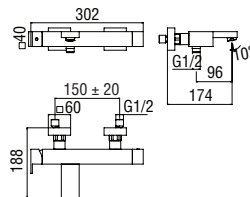

Cromo lucido	MQ102110/1CR	730,00 €
Inox spazzolato	MQ102110/1IX	1.093,00 €
Mora opaco	MQ102110/1BM	1.093,00 €



CARTRIDGE WARRANTY



RCR350  
39,00 €



RCR201/59  
51,00 €



RAEK220/14CR  
45,00 € - 10 pz.

**Termostatico esterno con set doccia**

- Blocco di sicurezza 38° C
- Valvole antiritorno
- Aeratore anticalcare M 24 x 1
- Supporto doccetta orientabile
- Doccetta monogetto e flessibile 150 cm
- Filtri di ricambio cartuccia inclusi nella confezione

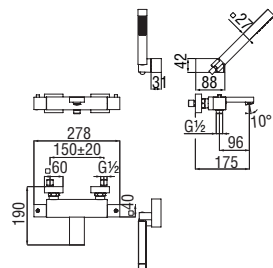

Cromo lucido	MQ102010CR	847,00 €
Inox spazzolato	MQ102010IX	1.273,00 €
Mora opaco	MQ102010BM	1.273,00 €



RCR201/5  
58,00 €



RCR201/70  
39,00 €



RAEK220/14CR  
45,00 € - 10 pz.

**Termostatico esterno**

- Blocco di sicurezza 38° C
- Valvole antiritorno
- Aeratore anticalcare M 24 x 1
- Uscita ø 1/2"
- Filtri di ricambio cartuccia inclusi nella confezione

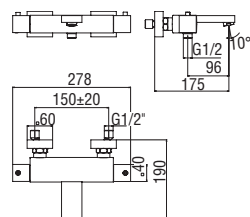

Cromo lucido	MQ102010/1CR	730,00 €
Inox spazzolato	MQ102010/1IX	1.093,00 €
Mora opaco	MQ102010/1BM	1.093,00 €



RCR201/5  
58,00 €



RCR201/70  
39,00 €



RAEK220/14CR  
45,00 € - 10 pz.

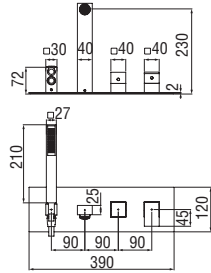

**Parte esterna monocomando incasso a 2 vie**

- Limitatore di portata con freno al 50%
- Deviatore a 2 vie
- Aeratore anticalcare M 28 x 1
- Supporto doccetta fisso
- Doccetta monogetto e flessibile 150 cm

Cromo lucido	WEBK110/90QCR	764,00 €
Inox spazzolato	WEBK110/90QIX	1.148,00 €
Mora opaco	WEBK110/90QBM	1.148,00 €



RAEK219/41CR  
47,00 € - 5 pz.



NR00212/23CR  
177,00 €

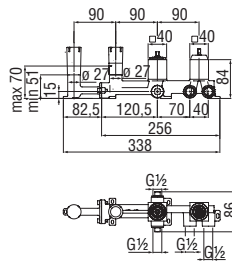

**Parte incasso necessaria**

- Ingresso acqua calda e acqua fredda ø 1/2"
- Uscite ø 1/2"

Cromo lucido	WE81201/QCR	442,00 €
Inox spazzolato	WE81201/QIX	663,00 €
Mora opaco	WE81201/QBM	663,00 €



CARTRIDGE  
WARRANTY



RCR350  
39,00 €



RCR201/35FSC  
39,00 €

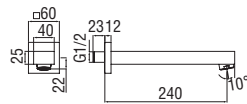

**Bocca a parete**

- Aeratore anticalcare M 28 x 1
- Lunghezza 240 mm

Cromo lucido	AV00158/38CR	180,00 €
Inox spazzolato	AV00158/38IX	269,00 €
Mora opaco	AV00158/38BM	269,00 €



RAEK219/41CR  
47,00 € - 5 pz.

DOCCIA

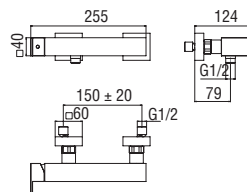

**Monocomando esterno**

- Limitatore di portata con freno al 50%
- Uscita ø 1/2"

Cromo lucido	MQ102130CR	529,00 €
Inox spazzolato	MQ102130IX	794,00 €
Mora opaco	MQ102130BM	794,00 €



CARTRIDGE  
WARRANTY

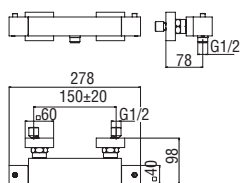

RCR350  
39,00 €

**Termostatico esterno**

- Blocco di sicurezza 38° C
- Valvole antiritorno
- Uscita ø 1/2"
- Filtri di ricambio cartuccia inclusi nella confezione

Cromo lucido	MQ102030CR	529,00 €
Inox spazzolato	MQ102030IX	794,00 €
Mora opaco	MQ102030BM	794,00 €

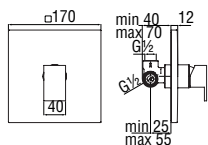
RCR201/5  
58,00 €RVT200/26  
18,00 €**Monocomando incasso a 1 via**

- Limitatore di portata con freno al 50%
- Tenuta o-ring invisibile
- Fissaggio a parete impermeabile
- Ingresso acqua calda e acqua fredda ø 1/2"
- Uscita ø 1/2"
- Parte esterna e parte incasso

Cromo lucido	M1102108CR	389,00 €
Inox spazzolato	M1102108IX	581,00 €
Mora opaco	M1102108BM	581,00 €

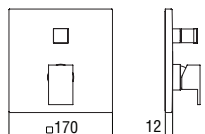
CARTRIDGE  
WARRANTYRCR350  
39,00 €NR00212/10CR  
43,00 €**Parte esterna monocomando incasso a 2 vie**

- Limitatore di portata con freno al 50%
- Deviatore con ritorno automatico
- Tenuta o-ring invisibile
- Fissaggio a parete impermeabile

Cromo lucido	M1102100/ECR	318,00 €
Inox spazzolato	M1102100/EIX	478,00 €
Mora opaco	M1102100/EBM	478,00 €

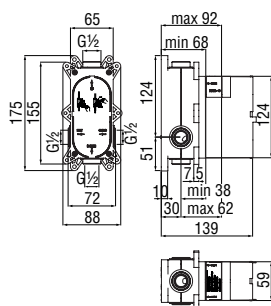
NR00212/13CR  
57,00 €**Easybox 2 vie, parte incasso necessaria**

- Ingresso e uscita acqua ø 1/2"
- Adatta anche a montaggio su cartongesso

Nota: disponibile il dispositivo antireflusso RVREN1717 (opzionale)

-	WE81100	135,00 €
---	---------	----------

CARTRIDGE  
WARRANTYRCR350  
39,00 €RVREN1717  
33,00 €



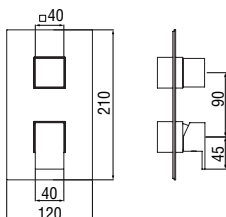

### Parte esterna monocomando incasso a 2-3 vie

- Limitatore di portata con freno al 50%
- Tenuta o-ring invisibile
- Fissaggio a parete impermeabile

Cromo lucido	WE81102/QCR	420,00 €
Inox spazzolato	WE81102/QIX	630,00 €
Mora opaco	WE81102/QBM	630,00 €

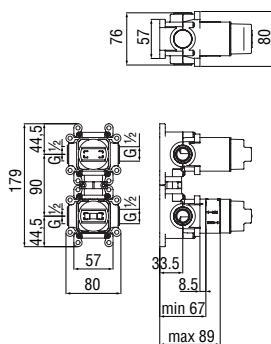

### Techbox 2 vie, parte incasso necessaria

- Deviatore a 2 vie ceramico
- Ingresso e uscita acqua  $\varnothing$  1/2"
- Adatta anche a montaggio su cartongesso

-	WE81102	160,00 €
---	---------	----------



CARTRIDGE  
WARRANTY



RCR350  
39,00 €



RCR201/35FSC  
39,00 €



NR00212/30  
85,00 €

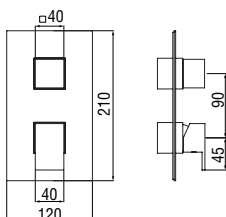

### Parte esterna monocomando incasso a 2-3 vie

- Limitatore di portata con freno al 50%
- Tenuta o-ring invisibile
- Fissaggio a parete impermeabile

Cromo lucido	WE81102/QCR	420,00 €
Inox spazzolato	WE81102/QIX	630,00 €
Mora opaco	WE81102/QBM	630,00 €

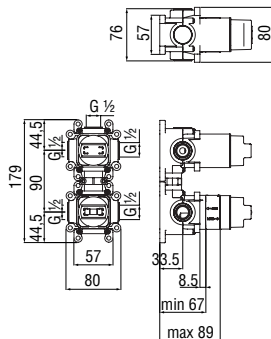

### Techbox 3 vie, parte incasso necessaria

- Deviatore a 3 vie ceramico
- Ingresso e uscita acqua  $\varnothing$  1/2"
- Adatta anche a montaggio su cartongesso

-	WE81103	184,00 €
---	---------	----------



CARTRIDGE  
WARRANTY



RCR350  
39,00 €



RCR201/35C  
39,00 €

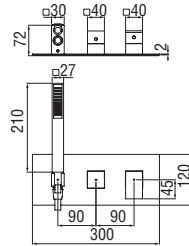

NR00212/32  
85,00 €

**Parte esterna monocomando incasso a 2 vie**

- Limitatore di portata con freno al 50%
- Supporto doccetta fisso
- Doccetta monogetto e flessibile 150 cm
- Deviatore a 2 vie
- Abbinamento libero per la seconda via

Cromo lucido	WESK100/QCR	670,00 €
Inox spazzolato	WESK100/QIX	1.005,00 €
Mora opaco	WESK100/QBM	1.005,00 €



NR00212/23CR  
177,00 €

**Parte incasso necessaria**

- Ingresso acqua calda e acqua fredda  $\varnothing$  1/2"
- Uscite  $\varnothing$  1/2"

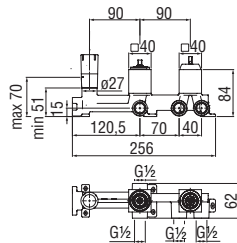

Cromo lucido	WE81200/QCR	390,00 €
Inox spazzolato	WE81200/QIX	585,00 €
Mora opaco	WE81200/QBM	585,00 €



CARTRIDGE  
WARRANTY



RCR350  
39,00 €



RCR201/35FSC  
39,00 €

## TERMOSTATICI INCASSO

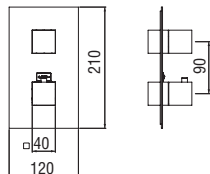
**Parte esterna termostatico a 1 via**

- Blocco di sicurezza 38° C
- Montaggio verticale o orizzontale

Cromo lucido	WE00101/QCR	519,00 €
Inox spazzolato	WE00101/QIX	779,00 €
Mora opaco	WE00101/QBM	779,00 €



NR00008  
34,00 €

**Wellbox 1 via, parte incasso necessaria**

- Ingresso e uscita acqua  $\varnothing$  1/2"
- Rubinetti di chiusura
- Valvole antiritorno
- Adatta anche a montaggio su cartongesso
- Filtri di ricambio cartuccia inclusi nella confezione

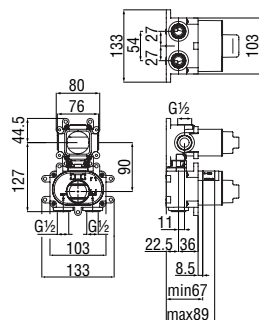

-	WE00101	167,00 €
---	---------	----------



RCR201/5  
58,00 €



RVT200/5D  
18,00 €

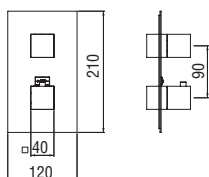

**Parte esterna termostatico a 2 vie**

- Blocco di sicurezza 38° C
- Montaggio verticale o orizzontale

Cromo lucido	WE00102/QCR	519,00 €
Inox spazzolato	WE00102/QIX	779,00 €
Mora opaco	WE00102/QBM	779,00 €



NR00008  
34,00 €

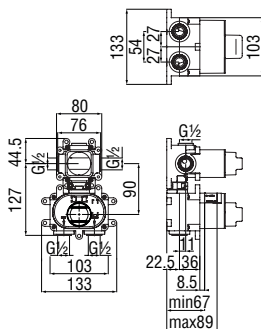

**Wellbox 2 vie, parte incasso necessaria**

- Ingresso e uscita acqua  $\varnothing$  1/2"
- Rubinetti di chiusura
- Valvole antiritorno
- Adatta anche a montaggio su cartongesso
- Filtri di ricambio cartuccia inclusi nella confezione

-	WE00102	215,00 €
---	---------	----------



RCR201/5  
58,00 €



RCR201/28  
39,00 €

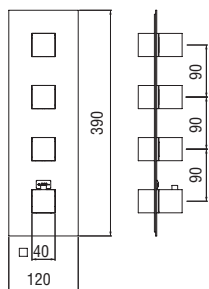

**Parte esterna termostatico a 3 vie**

- Blocco di sicurezza 38° C
- Montaggio verticale o orizzontale

Cromo lucido	WE00103/QCR	965,00 €
Inox spazzolato	WE00103/QIX	1.447,00 €
Mora opaco	WE00103/QBM	1.447,00 €



NR00008  
34,00 €

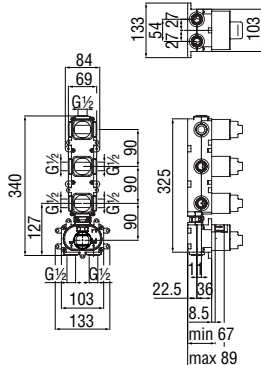

**Wellbox 3 vie, parte incasso necessaria**

- Ingresso e uscita acqua  $\varnothing$  1/2"
- Rubinetti di chiusura
- Valvole antiritorno
- Adatta anche a montaggio su cartongesso
- Filtri di ricambio cartuccia inclusi nella confezione

-	WE00103	318,00 €
---	---------	----------



RCR201/5  
58,00 €



RVT200/5D  
18,00 €

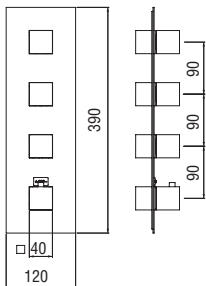

**Parte esterna termostatico a 4 vie**

- Blocco di sicurezza 38° C
- Montaggio verticale o orizzontale

Cromo lucido	WE00104/QCR	965,00 €
Inox spazzolato	WE00104/QIX	1.447,00 €
Mora opaco	WE00104/QBM	1.447,00 €

  
NR00008  
34,00 €

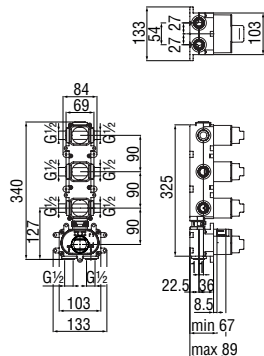

**Wellbox 4 vie, parte incasso necessaria**

- Ingresso e uscita acqua ø 1/2"
- Rubinetti di chiusura
- Valvole antiritorno
- Adatta anche a montaggio su cartongesso
- Filtri di ricambio cartuccia inclusi nella confezione

-	WE00104	360,00 €
---	---------	----------

  
RCR201/5  
58,00 €

  
RCR201/28  
39,00 €

  
RVT200/5D  
18,00 €

RUBINETTERIA NOBILI

# SOFÌ

Centro Stile Nobili

Portamento maestoso, stile solenne: un continuo susseguirsi di curve morbide e spigoli vivi. Andamento classico, eleganza raffinata: Sofì reinventa la storia dell'arte e propone all'interno della sala da bagno un favoloso incontro tra sapori lontani e ispirazioni moderne.



Cromo lucido

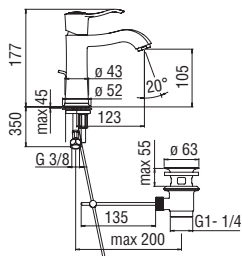

Caffè spazzolato

**Monocomando**

- Limitatore di portata con freno al 50%
- Aeratore anticalcare M 24 x 1
- Scarico 1 1/4" con sistema brevettato SNAP
- Flessibili inox ø 3/8"

Cromo lucido	SI98118/1CR	293,00 €
Caffè spazzolato	SI98118/1SB	<b>NEW</b> 469,00 €



CARTRIDGE  
WARRANTY



RCR280/D  
39,00 €

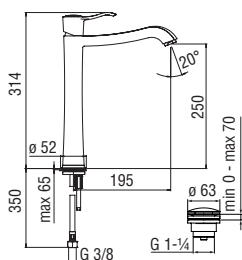

RAEK220/37CR  
47,00 € - 10 pz.

**Monocomando a bacinella**

- Limitatore di portata con freno al 50%
- Aeratore anticalcare M 24 x 1
- Scarico 1 1/4" push
- Flessibili inox ø 3/8"

Cromo lucido	SI98128/2CR	389,00 €
Caffè spazzolato	SI98128/2SB	<b>NEW</b> 622,00 €



CARTRIDGE  
WARRANTY



RCR280/D  
39,00 €

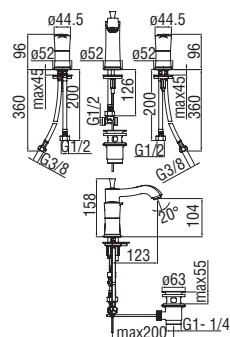

RAEK220/37CR  
47,00 € - 10 pz.

**Batteria 3 fori**

- Aeratore anticalcare M 24 x 1
- Scarico 1 1/4" con sistema brevettato SNAP

Cromo lucido	SI98211/1CR	431,00 €
Caffè spazzolato	SI98211/1SB	<b>NEW</b> 690,00 €



RVT200/5D  
18,00 €



RVT200/5S  
18,00 €

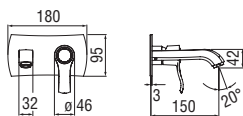

RAEK220/37CR  
47,00 € - 10 pz.

**Parte esterna monocomando a parete**

- Limitatore di portata con freno al 50%
- Aeratore anticalcare M 24 x 1
- Lunghezza bocca 150 mm
- Senza scarico

Cromo lucido	SI98198CR	280,00 €
Caffè spazzolato	SI98198SB	<b>NEW</b> 448,00 €



RAEK220/37CR  
47,00 € - 10 pz.

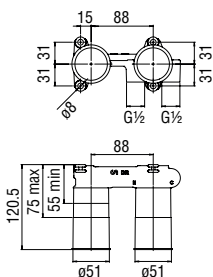

NR00212/10CR  
43,00 €

**Allbox, parte incasso necessaria**

- Ingresso acqua calda e acqua fredda  $\varnothing$  1/2"
- Uscita  $\varnothing$  1/2"

-	WE00198	<b>MOD</b>	125,00 €
---	---------	------------	----------



CARTRIDGE  
WARRANTY

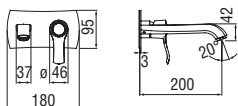

RCR350  
39,00 €

**Parte esterna monocomando a parete bocca lunga**

- Limitatore di portata con freno al 50%
- Aeratore anticalcare M 24 x 1
- Lunghezza bocca 200 mm
- Senza scarico

Cromo lucido	SI98198/1CR	355,00 €
Caffè spazzolato	SI98198/1SB	<b>NEW</b> 568,00 €



RAEK220/37CR  
47,00 € - 10 pz.

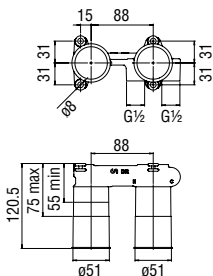

NR00212/10CR  
43,00 €

**Allbox, parte incasso necessaria**

- Ingresso acqua calda e acqua fredda  $\varnothing$  1/2"
- Uscita  $\varnothing$  1/2"

-	WE00198	<b>MOD</b>	125,00 €
---	---------	------------	----------



CARTRIDGE  
WARRANTY



RCR350  
39,00 €

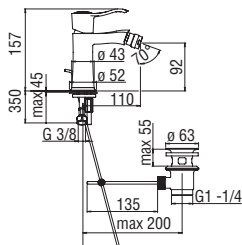

**Monocomando**

- Limitatore di portata con freno al 50%
- Aeratore anticalcare M 24 x 1
- Getto orientabile
- Scarico 1 1/4" con sistema brevettato SNAP
- Flessibili inox ø 3/8"

Cromo lucido	SI98119/1CR	293,00 €
Caffè spazzolato	SI98119/1SB	<b>NEW</b> 469,00 €



CARTRIDGE  
WARRANTY



RCR280/D  
39,00 €



RAE220/37CR  
21,00 € - 1 pz.

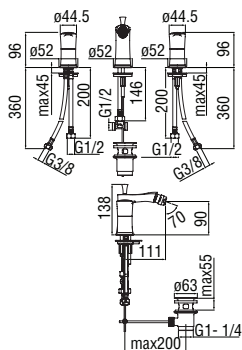

**Batteria 3 fori**

- Aeratore anticalcare M 22 x 1
- Getto orientabile
- Scarico 1 1/4" con sistema brevettato SNAP

Cromo lucido	SI98215/1CR	431,00 €
Caffè spazzolato	SI98215/1SB	<b>NEW</b> 690,00 €



RVT200/5S  
18,00 €



RVT200/5D  
18,00 €



RAE220/37CR  
21,00 € - 1 pz.

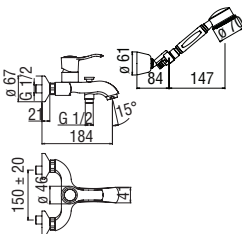

**Monocomando esterno con set doccia**

- Limitatore di portata con freno al 50%
- Aeratore anticalcare M 28 x 1
- Deviatore con ritorno automatico
- Supporto doccetta orientabile
- Doccetta monogetto e flessibile 150 cm

Cromo lucido	SI98110CR	757,00 €
Caffè spazzolato	SI98110SB	<b>NEW</b> 1.211,00 €



CARTRIDGE  
WARRANTY



RCR360/D  
39,00 €



RAEK219/41CR  
47,00 € - 5 pz.

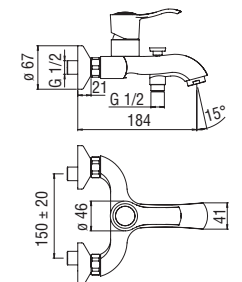

**Monocomando esterno**

- Limitatore di portata con freno al 50%
- Aeratore anticalcare M 28 x 1
- Deviatore con ritorno automatico
- Uscita ø 1/2"

Cromo lucido	SI98110/1CR	530,00 €
Caffè spazzolato	SI98110/1SB	<b>NEW</b> 848,00 €



CARTRIDGE  
WARRANTY



RCR360/D  
39,00 €



RAEK219/41CR  
47,00 € - 5 pz.



**Bocca a parete**

- Aeratore anticalcare M 24 x 1
- Lunghezza 200 mm

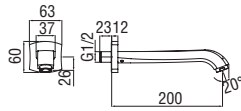

Cromo lucido	AV00158/41CR	182,00 €
Caffè spazzolato	AV00158/41SB	<b>NEW</b> 291,00 €

 RAEK220/14CR  
45,00 € - 10 pz.

**DOCCIA**

**Monocomando esterno**

- Limitatore di portata con freno al 50%
- Uscita ø 1/2"

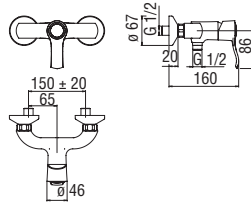

Cromo lucido	SI98130CR	420,00 €
Caffè spazzolato	SI98130SB	<b>NEW</b> 672,00 €

 **20 YEARS**  
CARTRIDGE WARRANTY

 RCR360/D  
39,00 €

**Monocomando incasso a 1 via**

- Limitatore di portata con freno al 50%
- Ingresso acqua calda e acqua fredda ø 1/2"
- Uscita ø 1/2"
- Parte esterna e parte incasso

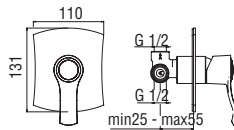

Cromo lucido	SI98108CR	300,00 €
Caffè spazzolato	SI98108SB	<b>NEW</b> 480,00 €

 **20 YEARS**  
CARTRIDGE WARRANTY

 RCR350  
39,00 €

 NR00212/10CR  
43,00 €

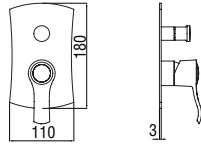
**Parte esterna monocomando incasso a 2 vie**

- Limitatore di portata con freno al 50%
- Deviatore con ritorno automatico

Cromo lucido	SI98100/ECR	285,00 €
Caffè spazzolato	SI98100/ESB	<b>NEW</b> 456,00 €

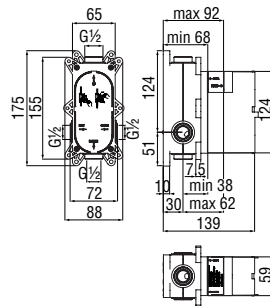

NR00212/13CR  
57,00 €

**Easybox 2 vie, parte incasso necessaria**

- Ingresso e uscita acqua  $\varnothing$  1/2"
- Adatta anche a montaggio su cartongesso

Nota: disponibile il dispositivo antireflusso RVREN1717 (opzionale)

-	WE81100	135,00 €
---	---------	----------



CARTRIDGE  
WARRANTY



RCR350  
39,00 €

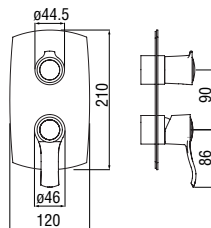

RVREN1717  
33,00 €

**Parte esterna monocomando incasso a 2-3 vie**

- Limitatore di portata con freno al 50%
- Tenuta o-ring invisibile
- Fissaggio a parete impermeabile

Cromo lucido	WE81102/SICR	415,00 €
Caffè spazzolato	WE81102/SISB	<b>NEW</b> 664,00 €

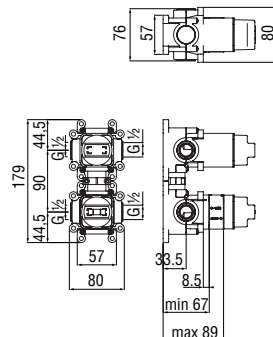
**Techbox 2 vie, parte incasso necessaria**

- Deviatore a 2 vie ceramico
- Ingresso e uscita acqua  $\varnothing$  1/2"
- Adatta anche a montaggio su cartongesso

-	WE81102	160,00 €
---	---------	----------



CARTRIDGE  
WARRANTY



RCR350  
39,00 €



RCR201/35FSC  
39,00 €

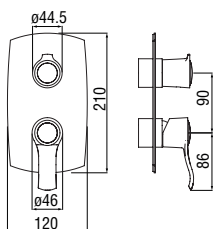

NR00212/30  
85,00 €

**Parte esterna monocomando incasso a 2-3 vie**

- Limitatore di portata con freno al 50%
- Tenuta o-ring invisibile
- Fissaggio a parete impermeabile

Cromo lucido	WE81102/SICR	415,00 €
Caffè spazzolato	WE81102/SISB	<b>NEW</b> 664,00 €

**Techbox 3 vie, parte incasso necessaria**

- Deviatore a 3 vie ceramico
- Ingresso e uscita acqua  $\varnothing$  1/2"
- Adatta anche a montaggio su cartongesso

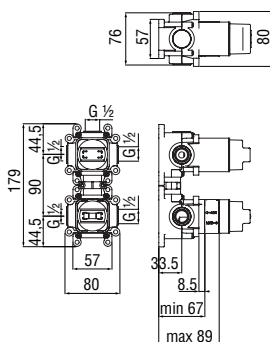

-	WE81103	184,00 €
---	---------	----------



CARTRIDGE  
WARRANTY



RCR350  
39,00 €



RCR201/35C  
39,00 €



NR00212/32  
85,00 €

## TERMOSTATICI INCASSO

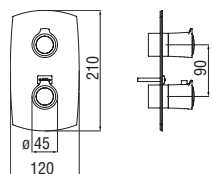
**Parte esterna termostatico a 1 via**

- Blocco di sicurezza 38° C
- Montaggio verticale o orizzontale

Cromo lucido	SI98101CR	417,00 €
Caffè spazzolato	SI98101SB	<b>NEW</b> 667,00 €



NR00008  
34,00 €

**Wellbox 1 via, parte incasso necessaria**

- Ingresso e uscita acqua  $\varnothing$  1/2"
- Rubinetti di chiusura
- Valvoline antiritorno
- Adatta anche a montaggio su cartongesso
- Filtri di ricambio cartuccia inclusi nella confezione

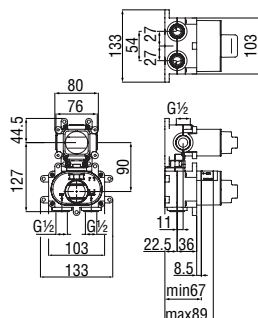

-	WE00101	167,00 €
---	---------	----------



RCR201/5  
58,00 €



RVT200/5D  
18,00 €

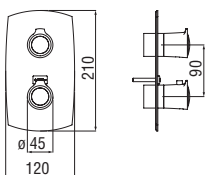

**Parte esterna termostatico a 2 vie**

- Blocco di sicurezza 38° C
- Montaggio verticale o orizzontale

Cromo lucido	SI98102CR	417,00 €
Caffè spazzolato	SI98102SB	<b>NEW</b> 667,00 €

  
NR00008  
34,00 €

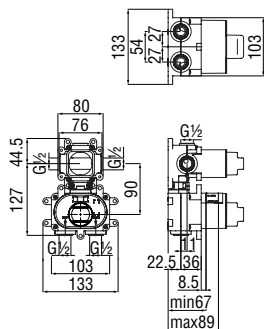

**Wellbox 2 vie, parte incasso necessaria**

- Ingresso e uscita acqua ø 1/2"
- Rubinetti di chiusura
- Valvole antiritorno
- Adatta anche a montaggio su cartongesso
- Filtri di ricambio cartuccia inclusi nella confezione

-	WE00102	215,00 €
---	---------	----------

  
RCR201/5  
58,00 €

  
RCR201/28  
39,00 €

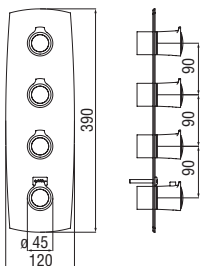

**Parte esterna termostatico a 3 vie**

- Blocco di sicurezza 38° C
- Montaggio verticale o orizzontale

Cromo lucido	SI98103CR	845,00 €
Caffè spazzolato	SI98103SB	<b>NEW</b> 1.352,00 €

  
NR00008  
34,00 €

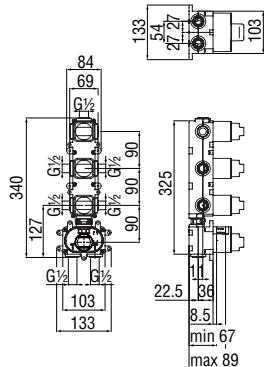

**Wellbox 3 vie, parte incasso necessaria**

- Ingresso e uscita acqua ø 1/2"
- Rubinetti di chiusura
- Valvole antiritorno
- Adatta anche a montaggio su cartongesso
- Filtri di ricambio cartuccia inclusi nella confezione

-	WE00103	318,00 €
---	---------	----------

  
RCR201/5  
58,00 €

  
RVT200/5D  
18,00 €

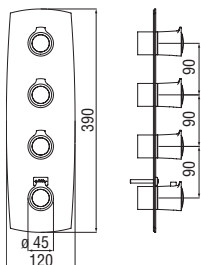

**Parte esterna termostatico a 4 vie**

- Blocco di sicurezza 38° C
- Montaggio verticale o orizzontale

Cromo lucido	SI98104CR	845,00 €
Caffè spazzolato	SI98104SB	<b>NEW</b> 1.352,00 €

  
NR00008  
34,00 €

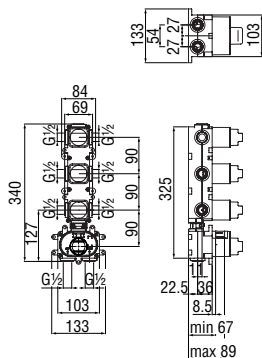

**Wellbox 4 vie, parte incasso necessaria**

- Ingresso e uscita acqua  $\varnothing$  1/2"
- Rubinetti di chiusura
- Valvole antiritorno
- Adatta anche a montaggio su cartongesso
- Filtri di ricambio cartuccia inclusi nella confezione

-	WE00104	360,00 €
---	---------	----------

  
RCR201/5  
58,00 €

  
RCR201/28  
39,00 €

  
RVT200/5D  
18,00 €



RUBINETTERIA NOBILI

# LIRA

Piet Billekens

Elementare nella sagoma ma nobile nella sua concezione, la forma dell'acqua si racconta iniziando il suo percorso da una linea, che nella sua essenzialità apre ad un mondo interpretativo poliedrico. Lira supera il concetto di moda, cristallizzando l'atemporalità del suo stile: il carattere è negli occhi di chi la guarda.



Cromo lucido



Grafite spazzolato PVD

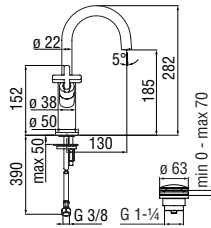

Mora opaco

**Bicomando**

- Aeratore anticalcare M 18,5 x 1, portata 5 l/min
- Bocca girevole
- Scarico 1 1/4" push
- Flessibili inox ø 3/8"

Cromo lucido	LR116218/2CR	373,00 €
Grafite spazzolato PVD	LR116218/2GUP	<b>NEW</b> 597,00 €
Mora opaco	LR116218/2BM	559,00 €



RVT200/26  
18,00 €

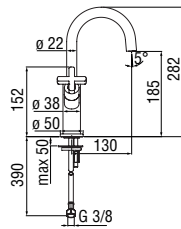

RAEK222/44  
61,00 € - 10 pz.

**Bicomando**

- Aeratore anticalcare M 18,5 x 1, portata 5 l/min
- Bocca girevole
- Senza scarico
- Flessibili inox ø 3/8"

Cromo lucido	LR116218/3CR	370,00 €
Grafite spazzolato PVD	LR116218/3GUP	<b>NEW</b> 592,00 €
Mora opaco	LR116218/3BM	554,00 €



RVT200/26  
18,00 €

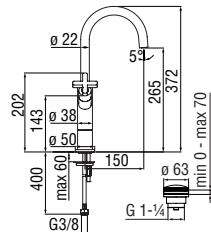

RAEK222/44  
61,00 € - 10 pz.

**Bicomando a bacinella**

- Aeratore anticalcare M 18,5 x 1, portata 5 l/min
- Bocca girevole
- Scarico 1 1/4" push
- Flessibili inox ø 3/8"

Cromo lucido	LR116258/2CR	476,00 €
Grafite spazzolato PVD	LR116258/2GUP	<b>NEW</b> 762,00 €
Mora opaco	LR116258/2BM	712,00 €



RVT200/26  
18,00 €

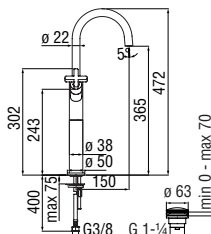

RAEK222/44  
61,00 € - 10 pz.

**Bicomando a bacinella**

- Aeratore anticalcare M 18,5 x 1, portata 5 l/min
- Bocca girevole
- Scarico 1 1/4" push
- Flessibili inox ø 3/8"

Cromo lucido	LR116228/2CR	525,00 €
Grafite spazzolato PVD	LR116228/2GUP	<b>NEW</b> 840,00 €
Mora opaco	LR116228/2BM	788,00 €



RVT200/26  
18,00 €



RAEK222/44  
61,00 € - 10 pz.



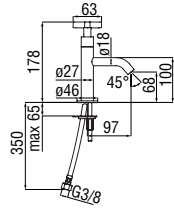

**Rubinetto monoacqua**

- Aeratore anticalcare M 16,5 x 1, portata 5 l/min
- Senza scarico
- Flessibile inox ø 3/8"

Cromo lucido	LR116236CR	191,00 €
Grafite spazzolato PVD	LR116236GUP	<b>NEW</b> 306,00 €
Mora opaco	LR116236BM	287,00 €

RVT200/5D  
18,00 €

RAEK219/28  
58,00 € - 10 pz.

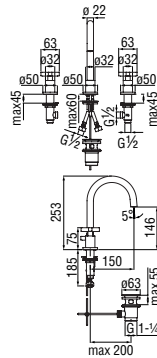

**Batteria 3 fori**

- Aeratore anticalcare M 18,5 x 1, portata 5 l/min
- Bocca girevole
- Scarico 1 1/4" con sistema brevettato SNAP

Cromo lucido	LR116211/1CR	396,00 €
Grafite spazzolato PVD	LR116211/1GUP	<b>NEW</b> 634,00 €
Mora opaco	LR116211/1BM	595,00 €

RVT200/10  
18,00 €

RAEK222/44  
61,00 € - 10 pz.

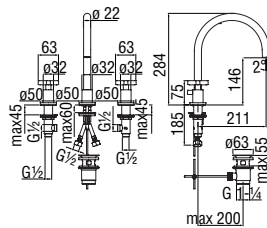

**Batteria 3 fori con bocca lunga**

- Aeratore anticalcare M 18,5 x 1, portata 5 l/min
- Bocca girevole
- Scarico 1 1/4" con sistema brevettato SNAP

Cromo lucido	LR116211/5CR	422,00 €
Grafite spazzolato PVD	LR116211/5GUP	<b>NEW</b> 675,00 €
Mora opaco	LR116211/5BM	633,00 €

RVT200/10  
18,00 €

RAEK222/44  
61,00 € - 10 pz.

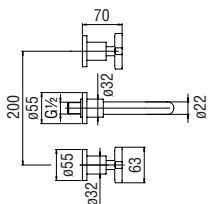
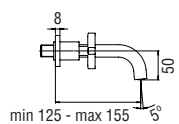
**Parte esterna batteria 3 fori a parete**

- Aeratore anticalcare M 18,5 x 1, portata 5 l/min
- Lunghezza bocca min 125 - max 155 mm
- Senza scarico

Cromo lucido	LR116298/ECR	264,00 €
Grafite spazzolato PVD	LR116298/EGUP	<b>NEW</b> 422,00 €
Mora opaco	LR116298/EBM	396,00 €



RAEK222/44  
61,00 € - 10 pz.

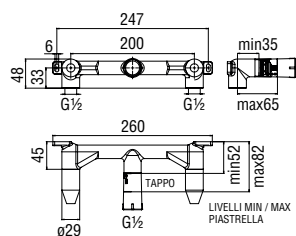
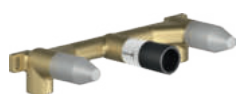

NR00212/28  
41,00 €

**Allbox, parte incasso necessaria**

- Ingresso acqua calda e acqua fredda  $\varnothing$  1/2"
- Uscita  $\varnothing$  1/2"

-	WE00298	130,00 €
---	---------	----------

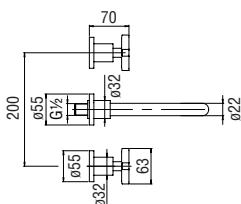
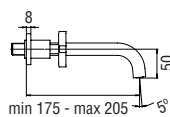
**Parte esterna batteria 3 fori a parete con bocca lunga**

- Aeratore anticalcare M 18,5 x 1, portata 5 l/min
- Lunghezza bocca min 175 - max 205 mm
- Senza scarico

Cromo lucido	LR116298/IECR	280,00 €
Grafite spazzolato PVD	LR116298/IEGUP	<b>NEW</b> 448,00 €
Mora opaco	LR116298/IEBM	420,00 €



RAEK222/44  
61,00 € - 10 pz.

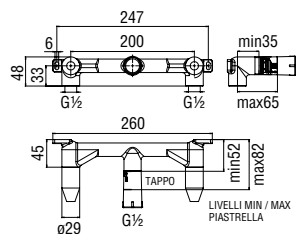

NR00212/28  
41,00 €

**Allbox, parte incasso necessaria**

- Ingresso acqua calda e acqua fredda  $\varnothing$  1/2"
- Uscita  $\varnothing$  1/2"

-	WE00298	130,00 €
---	---------	----------

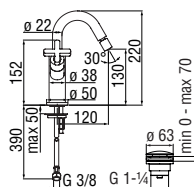

**Bicomando**

- Aeratore anticalcare M 18,5 x 1, portata 5 l/min
- Bocca girevole
- Getto orientabile
- Scarico 1 1/4" push
- Flessibili inox ø 3/8"

Cromo lucido	LR116219/2CR		373,00 €
Grafite spazzolato PVD	LR116219/2GUP	<b>NEW</b>	597,00 €
Mora opaco	LR116219/2BM		559,00 €



RVT200/26  
18,00 €



RAE222/44CR  
22,00 € - 10 pz.

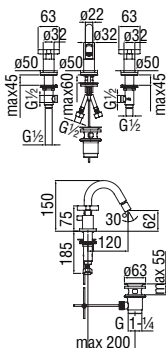

**Batteria 3 fori**

- Aeratore anticalcare M 18,5 x 1, portata 5 l/min
- Bocca girevole
- Getto orientabile
- Scarico 1 1/4" con sistema brevettato SNAP
- Flessibili inox ø 3/8"

Cromo lucido	LR116215/1CR		396,00 €
Grafite spazzolato PVD	LR116215/1GUP	<b>NEW</b>	634,00 €
Mora opaco	LR116215/1BM		595,00 €



RVT200/10  
18,00 €



RAE222/44CR  
22,00 € - 10 pz.

VASCA A PAVIMENTO

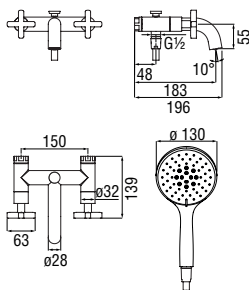

**Gruppo esterno con set doccia**

- Aeratore anticalcare M 24 x 1
- Deviatore con ritorno automatico
- Doccetta a 3 getti e flessibile 150 cm

Cromo lucido	LR116210/2SCR	<b>MOD</b>	510,00 €
Grafite spazzolato PVD	LR116210/2SGUP	<b>NEW</b>	816,00 €
Mora opaco	LR116210/2SBM	<b>MOD</b>	765,00 €



RVT200/26  
18,00 €



RAEK222/22  
45,00 € - 10 pz.

**Colonne a pavimento**

- Supporto doccetta fisso
- Attacco ø 3/4" x 1/2"

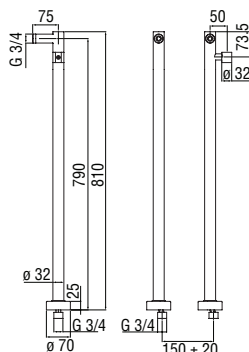

Cromo lucido	AV00151/11CR		486,00 €
Grafite spazzolato PVD	AV00151/11GUP	<b>NEW</b>	778,00 €
Mora opaco	AV00151/11BM		730,00 €



**Batteria 5 fori bordo vasca**

- Aeratore anticalcare M 18,5 x 1
- Deviatore a 2 vie
- Doccetta a 3 getti estraibile

Cromo lucido	WEBK204/LRCR	<b>MOD</b>	754,00 €
Grafite spazzolato PVD	WEBK204/LRGUP	<b>NEW</b>	1.206,00 €
Mora opaco	WEBK204/LRBM	<b>MOD</b>	1.130,00 €

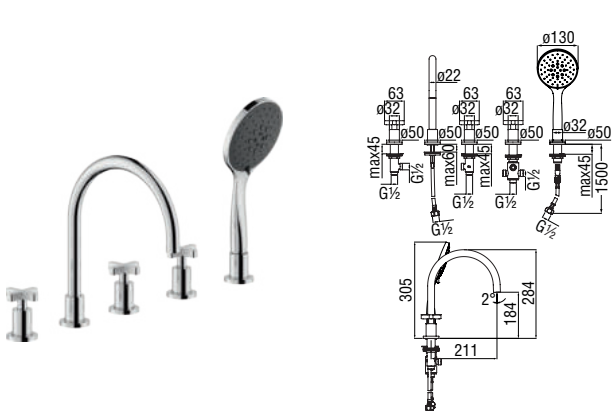

**Batteria 5 fori bordo vasca con bocca lunga**

- Aeratore anticalcare M 18,5 x 1
- Deviatore a 2 vie
- Doccetta a 3 getti estraibile

Cromo lucido	WEBK204/LRCR	<b>MOD</b>	805,00 €
Grafite spazzolato PVD	WEBK204/LRGUP	<b>NEW</b>	1.288,00 €
Mora opaco	WEBK204/LRBM	<b>MOD</b>	1.208,00 €



VASCA

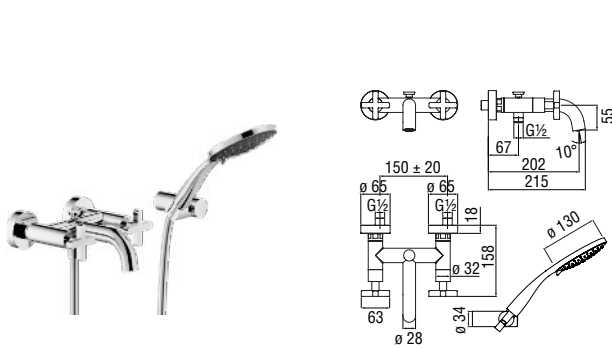

**Gruppo esterno con set doccia**

- Aeratore anticalcare M 24 x 1
- Deviatore con ritorno automatico
- Supporto doccetta orientabile
- Doccetta a 3 getti e flessibile 150 cm

Cromo lucido	LR116210CR	<b>MOD</b>	510,00 €
Grafite spazzolato PVD	LR116210GUP	<b>NEW</b>	816,00 €
Mora opaco	LR116210BM	<b>MOD</b>	765,00 €

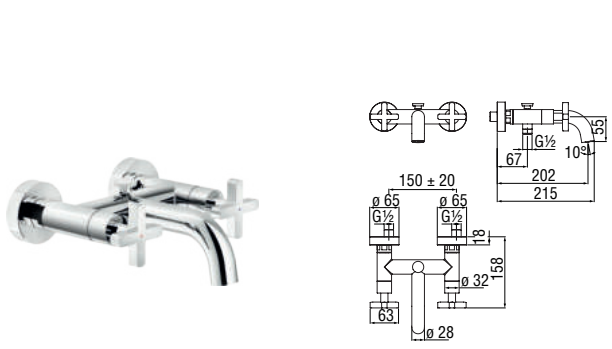

**Gruppo esterno**

- Aeratore anticalcare M 24 x 1
- Deviatore con ritorno automatico
- Uscita ø 1/2"

Cromo lucido	LR116210/1CR		410,00 €
Grafite spazzolato PVD	LR116210/1GUP	<b>NEW</b>	656,00 €
Mora opaco	LR116210/1BM		614,00 €



**Gruppo esterno**

· Uscita ø 1/2"

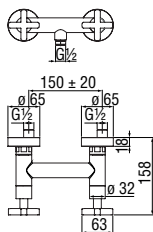

Cromo lucido	LR116230CR		345,00 €
Grafite spazzolato PVD	LR116230GUP	<b>NEW</b>	552,00 €
Mora opaco	LR116230BM		517,00 €

RVT200/26  
18,00 €**Coppia di rubinetti d'arresto a incasso**

· Ingresso a 2 vie

· Uscite ø 1/2"

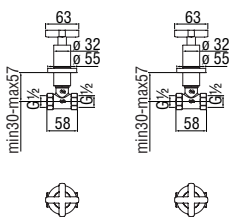

Cromo lucido	LRK116208/1CR		294,00 €
Grafite spazzolato PVD	LRK116208/1GUP	<b>NEW</b>	470,00 €
Mora opaco	LRK116208/1BM		442,00 €

RVT200/26  
18,00 €NR00212/26  
38,00 €**Deviatore 2 vie**

· Ingresso a 2 vie

· Uscite ø 1/2"

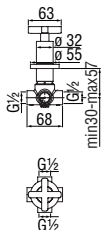

Cromo lucido	LR116160CR		230,00 €
Grafite spazzolato PVD	LR116160GUP	<b>NEW</b>	368,00 €
Mora opaco	LR116160BM		347,00 €

NR00212/27  
24,00 €

**Parte esterna termostatico a 1 via**

- Blocco di sicurezza 38° C
- Montaggio verticale o orizzontale

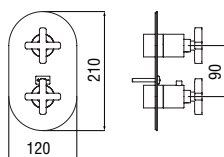

Cromo lucido	LR116101CR	463,00 €
Grafite spazzolato PVD	LR116101GUP	<b>NEW</b> 741,00 €
Mora opaco	LR116101BM	695,00 €

NR00008  
34,00 €

**Wellbox 1 via, parte incasso necessaria**

- Ingresso e uscita acqua ø 1/2"
- Rubinetti di chiusura
- Valvole antiritorno
- Adatta anche a montaggio su cartongesso
- Filtri di ricambio cartuccia inclusi nella confezione

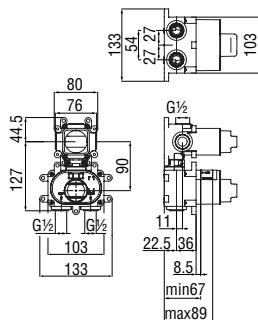

-	WE00101	167,00 €
---	---------	----------

RCR201/5  
58,00 €

RVT200/5D  
18,00 €

**Parte esterna termostatico a 2 vie**

- Blocco di sicurezza 38° C
- Montaggio verticale o orizzontale

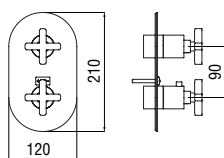

Cromo lucido	LR116102CR	463,00 €
Grafite spazzolato PVD	LR116102GUP	<b>NEW</b> 741,00 €
Mora opaco	LR116102BM	695,00 €

NR00008  
34,00 €

**Wellbox 2 vie, parte incasso necessaria**

- Ingresso e uscita acqua ø 1/2"
- Rubinetti di chiusura
- Valvole antiritorno
- Adatta anche a montaggio su cartongesso
- Filtri di ricambio cartuccia inclusi nella confezione

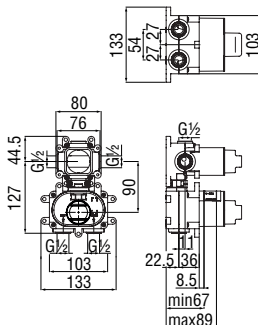

-	WE00102	215,00 €
---	---------	----------

RCR201/5  
58,00 €

RCR201/28  
39,00 €

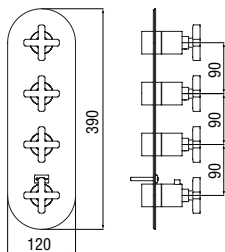

**Parte esterna termostatico a 3 vie**

- Blocco di sicurezza 38° C
- Montaggio verticale o orizzontale

Cromo lucido	LR116103CR	868,00 €
Grafite spazzolato PVD	LR116103GUP	<b>NEW</b> 1.389,00 €
Mora opaco	LR116103BM	1.303,00 €



NR00008  
34,00 €

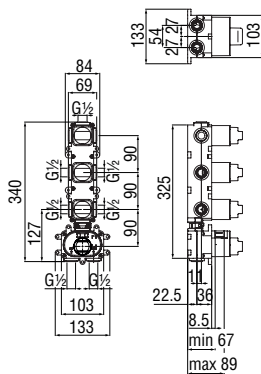

**Wellbox 3 vie, parte incasso necessaria**

- Ingresso e uscita acqua  $\varnothing$  1/2"
- Rubinetti di chiusura
- Valvole antiritorno
- Adatta anche a montaggio su cartongesso
- Filtri di ricambio cartuccia inclusi nella confezione

-	WE00103	318,00 €
---	---------	----------



RCR201/5  
58,00 €



RVT200/5D  
18,00 €

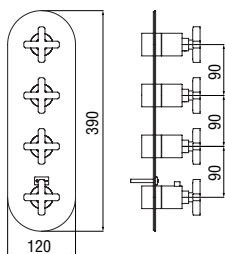

**Parte esterna termostatico a 4 vie**

- Blocco di sicurezza 38° C
- Montaggio verticale o orizzontale

Cromo lucido	LR116104CR	868,00 €
Grafite spazzolato PVD	LR116104GUP	<b>NEW</b> 1.389,00 €
Mora opaco	LR116104BM	1.303,00 €



NR00008  
34,00 €

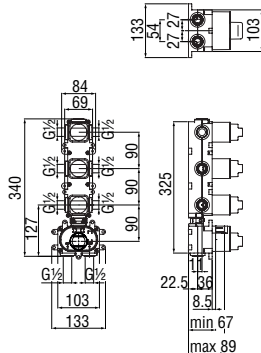

**Wellbox 4 vie, parte incasso necessaria**

- Ingresso e uscita acqua  $\varnothing$  1/2"
- Rubinetti di chiusura
- Valvole antiritorno
- Adatta anche a montaggio su cartongesso
- Filtri di ricambio cartuccia inclusi nella confezione

-	WE00104	360,00 €
---	---------	----------



RCR201/5  
58,00 €



RCR201/28  
39,00 €



RVT200/5D  
18,00 €





RUBINETTERIA NOBILI

# CARLOS PRIMERO

Piet Billekens

Carlos Primero esprime il passaggio generazionale tra ricordi di stile e nuovi percorsi. L'eleganza è vestita da abiti sensuali e cattura gli sguardi attraverso una gamma completa, adatta ad ambienti raffinati e signorili: miscelatori per lavabo, bidet, vasca oppure doccia, oltre ad una ricca proposta di accessori coordinati.



Cromo lucido



Miele spazzolato PVD

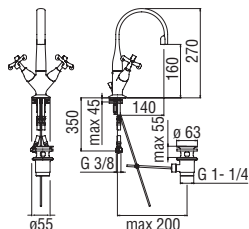

Caffè spazzolato

**Bicomando**

- Aeratore anticalcare M 16,5 x 1
- Bocca girevole
- Scarico 1 1/4" con sistema brevettato SNAP
- Flessibili inox ø 3/8"

Cromo lucido	CP218/1CR	305,00 €
Miele spazzolato PVD	CP218/1CGP	<b>NEW</b> 488,00 €
Caffè spazzolato	CP218/1SB	<b>NEW</b> 488,00 €



RVT200/26  
18,00 €

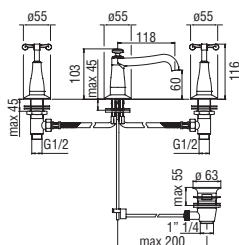

RAEK219/280  
61,00 € - 10 pz.

**Batteria 3 fori**

- Scarico 1 1/4" con sistema brevettato SNAP

Cromo lucido	CP211/1CR	382,00 €
Miele spazzolato PVD	CP211/1CGP	<b>NEW</b> 611,00 €
Caffè spazzolato	CP211/1SB	<b>NEW</b> 611,00 €

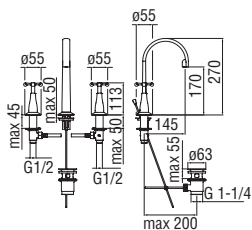

RVT200/26  
18,00 €

**Batteria 3 fori**

- Aeratore anticalcare M 16,5 x 1
- Scarico 1 1/4" con sistema brevettato SNAP

Cromo lucido	CP212/1CR	448,00 €
Miele spazzolato PVD	CP212/1CGP	<b>NEW</b> 717,00 €
Caffè spazzolato	CP212/1SB	<b>NEW</b> 717,00 €



RVT200/26  
18,00 €

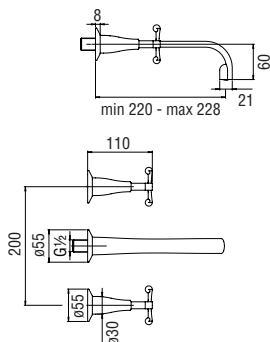

RAEK219/280  
61,00 € - 10 pz.

**Parte esterna batteria 3 fori a parete**

- Aeratore anticalcare M 16,5 x 1
- Lunghezza bocca min 220 - max 228 mm
- Senza scarico

Cromo lucido	CP298/ECR		318,00 €
Miele spazzolato PVD	CP298/ECGP	NEW	509,00 €
Caffè spazzolato	CP298/ESB	NEW	509,00 €



RAEK219/280  
61,00 € - 10 pz.



NR00212/31CR  
82,00 €

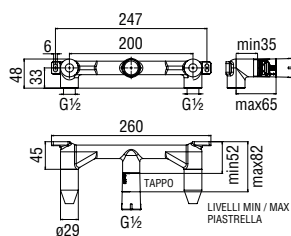

-	WE00298		130,00 €
---	---------	--	----------

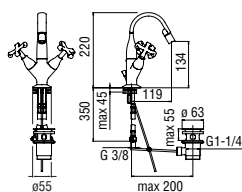
**Bicomando**

- Aeratore anticalcare M 16,5 x 1
- Bocca girevole
- Getto orientabile
- Scarico 1 1/4" con sistema brevettato SNAP
- Flessibili inox ø 3/8"

Cromo lucido	CP219/1CR		305,00 €
Miele spazzolato PVD	CP219/1CGP	NEW	488,00 €
Caffè spazzolato	CP219/1SB	NEW	488,00 €



RVT200/26  
18,00 €

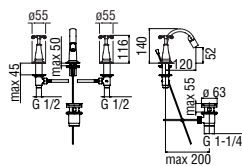

RAE219/280CR  
27,00 € - 1 pz.

**Batteria 3 fori**

- Aeratore anticalcare M 16,5 x 1
- Getto orientabile
- Scarico 1 1/4" con sistema brevettato SNAP

Cromo lucido	CP215/1CR		448,00 €
Miele spazzolato PVD	CP215/1CGP	NEW	717,00 €
Caffè spazzolato	CP215/1SB	NEW	717,00 €



RVT200/26  
18,00 €



RAE219/280CR  
27,00 € - 1 pz.

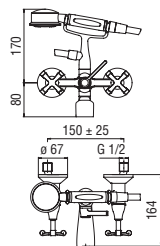

**Gruppo esterno con set doccia**

- Deviatore manuale
- Supporto doccetta fisso
- Doccetta monogetto e flessibile 150 cm

Cromo lucido	CP210CR	525,00 €
Miele spazzolato PVD	CP210CGP	<b>NEW</b> 840,00 €
Caffè spazzolato	CP210SB	<b>NEW</b> 840,00 €

 RVT200/26  
18,00 €

**Colonne a pavimento**

- Attacco ø 3/4" x 1/2"

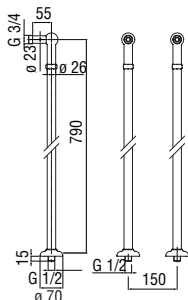

Cromo lucido	AV00151/10CR	641,00 €
Miele spazzolato PVD	AV00151/10CGP	<b>NEW</b> 1.026,00 €
Caffè spazzolato	AV00151/10SB	<b>NEW</b> 1.026,00 €

VASCA

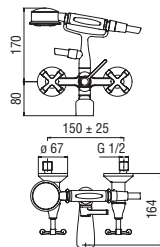

**Gruppo esterno con set doccia**

- Deviatore manuale
- Supporto doccetta fisso
- Doccetta monogetto e flessibile 150 cm

Cromo lucido	CP210CR	525,00 €
Miele spazzolato PVD	CP210CGP	<b>NEW</b> 840,00 €
Caffè spazzolato	CP210SB	<b>NEW</b> 840,00 €

 RVT200/26  
18,00 €

DOCCIA

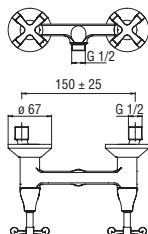

**Gruppo esterno**

- Uscita ø 1/2"

Cromo lucido	CP230CR	285,00 €
Miele spazzolato PVD	CP230CGP	<b>NEW</b> 456,00 €
Caffè spazzolato	CP230SB	<b>NEW</b> 456,00 €

 RVT200/26  
18,00 €

**Coppia di rubinetti d'arresto a incasso**

- Ingresso a 2 vie
- Uscite  $\varnothing 1/2"$

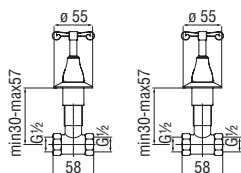

Cromo lucido	CPK208/ICR		328,00 €
Miele spazzolato PVD	CPK208/ICGP	NEW	525,00 €
Caffè spazzolato	CPK208/1SB	NEW	525,00 €



RVT200/26  
18,00 €



NR00212/26  
38,00 €

**Deviatore a 2 vie**

- Ingresso a 2 vie
- Uscite  $\varnothing 1/2"$

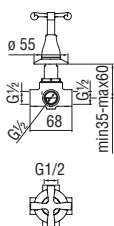

Cromo lucido	CP160CR		258,00 €
Miele spazzolato PVD	CP160CGP	NEW	413,00 €
Caffè spazzolato	CP160SB	NEW	413,00 €



RCR201/45  
21,00 €



NR00212/27  
24,00 €

**TERMOSTATICI INCASSO****Parte esterna termostatico a 1 via**

- Blocco di sicurezza 38° C
- Montaggio verticale o orizzontale

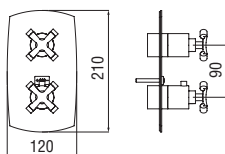

Cromo lucido	CP101CR		442,00 €
Miele spazzolato PVD	CP101CGP	NEW	707,00 €
Caffè spazzolato	CP101SB	NEW	707,00 €



NR00008  
34,00 €

**Wellbox 1 via, parte incasso necessaria**

- Ingresso e uscita acqua  $\varnothing 1/2"$
- Rubinetti di chiusura
- Valvole antiritorno
- Adatta anche a montaggio su cartongesso
- Filtri di ricambio cartuccia inclusi nella confezione

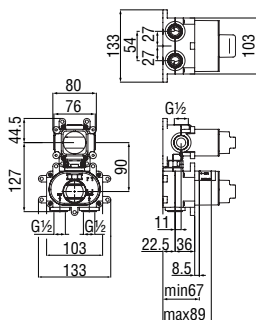

-	WE00101		167,00 €
---	---------	--	----------



RCR201/5  
58,00 €



RVT200/5D  
18,00 €

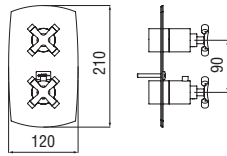

**Parte esterna termostatico a 2 vie**

- Blocco di sicurezza 38° C
- Montaggio verticale o orizzontale

Cromo lucido	CPI02CR	442,00 €
Miele spazzolato PVD	CPI02CGP	<b>NEW</b> 707,00 €
Caffè spazzolato	CPI02SB	<b>NEW</b> 707,00 €

  
NR00008  
34,00 €

**Wellbox 2 vie, parte incasso necessaria**

- Ingresso e uscita acqua ø 1/2"
- Rubinetti di chiusura
- Valvole antiritorno
- Adatta anche a montaggio su cartongesso
- Filtri di ricambio cartuccia inclusi nella confezione

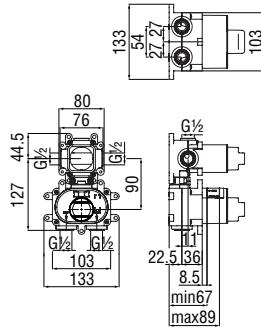

-	WE00102	215,00 €
---	---------	----------

  
RCR201/5  
58,00 €

  
RCR201/28  
39,00 €

**Parte esterna termostatico a 3 vie**

- Blocco di sicurezza 38° C
- Montaggio verticale o orizzontale

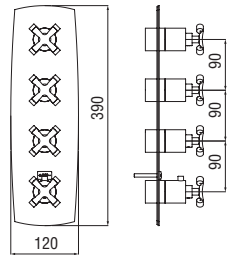

Cromo lucido	CPI03CR	884,00 €
Miele spazzolato PVD	CPI03CGP	<b>NEW</b> 1.414,00 €
Caffè spazzolato	CPI03SB	<b>NEW</b> 1.414,00 €

  
NR00008  
34,00 €

**Wellbox 3 vie, parte incasso necessaria**

- Ingresso e uscita acqua ø 1/2"
- Rubinetti di chiusura
- Valvole antiritorno
- Adatta anche a montaggio su cartongesso
- Filtri di ricambio cartuccia inclusi nella confezione

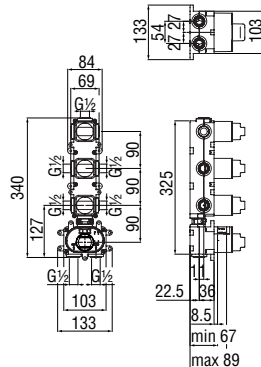

-	WE00103	318,00 €
---	---------	----------

  
RCR201/5  
58,00 €

  
RVT200/5D  
18,00 €

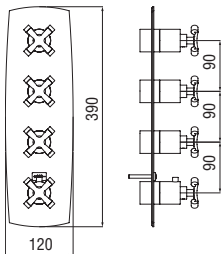

**Parte esterna termostatico a 4 vie**

- Blocco di sicurezza 38° C
- Montaggio verticale o orizzontale

Cromo lucido	CPI04CR		884,00 €
Miele spazzolato PVD	CPI04CGP	NEW	1.414,00 €
Caffè spazzolato	CPI04SB	NEW	1.414,00 €

  
NR00008  
34,00 €

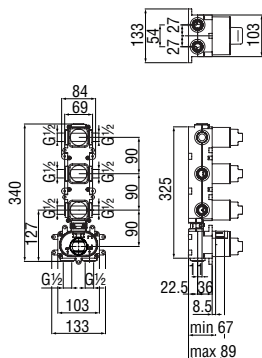

**Wellbox 4 vie, parte incasso necessaria**

- Ingresso e uscita acqua  $\varnothing$  1/2"
- Rubinetti di chiusura
- Valvole antiritorno
- Adatta anche a montaggio su cartongesso
- Filtri di ricambio cartuccia inclusi nella confezione

-	WE00104	360,00 €
---	---------	----------

 RCR201/5 58,00 €      RCR201/28 39,00 €      RVT200/5D 18,00 €





RUBINETTERIA NOBILI

# GRAZIA

Centro Stile Nobili

Giochi di contrasto in stile retrò. Sensazioni di piacevole tranquillità. Pace e benessere di un passato lontano: la collezione Grazia riporta in vita il fascino e la suggestione dei tempi antichi, mescolando un marcato stile novecentesco alla più moderna innovazione tecnologica del nostro brand.



Cromo lucido

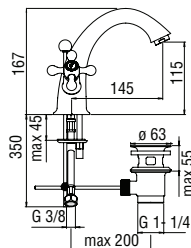

Miele spazzolato PVD

**Bicomando**

- Aeratore anticalcare M 24 x 1
- Scarico 1 1/4" con sistema brevettato SNAP
- Flessibili inox ø 3/8"

Cromo lucido	GRC5118/6CR	295,00 €
Miele spazzolato PVD	GRC5118/6CGP	<b>NEW</b> 472,00 €



RVT200/5D  
18,00 €

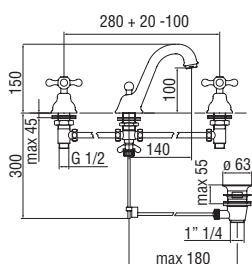

RAEK220/37CR  
47,00 € - 10 pz.

**Batteria 3 fori**

- Aeratore anticalcare M 24 x 1
- Scarico 1 1/4" con sistema brevettato SNAP

Cromo lucido	GRC5011/1CR	273,00 €
Miele spazzolato PVD	GRC5011/1CGP	<b>NEW</b> 437,00 €



RVT200/5D  
18,00 €



RAEK220/37CR  
47,00 € - 10 pz.

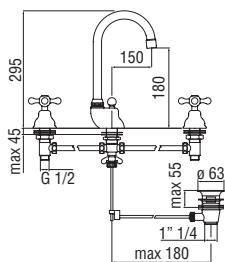

NR00212/1  
19,00 €

**Batteria 3 fori**

- Aeratore anticalcare M 22 x 1
- Bocca girevole
- Scarico 1 1/4" con sistema brevettato SNAP

Cromo lucido	GRC5012/1CR	270,00 €
Miele spazzolato PVD	GRC5012/1CGP	<b>NEW</b> 432,00 €



RVT200/5D  
18,00 €



RAEK219/63CR  
53,00 € - 10 pz.

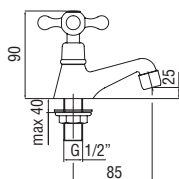

NR00212/1  
19,00 €

**Rubinetto monoacqua**

- Aeratore anticalcare M 22 x 1
- Senza scarico

Cromo lucido	GRC5004/2CR	70,00 €
Miele spazzolato PVD	GRC5004/2CGP	<b>NEW</b> 112,00 €



RVT200/5D  
18,00 €



RAEK219/63CR  
53,00 € - 10 pz.

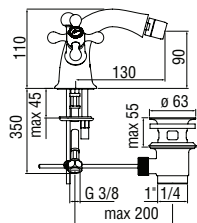

**Bicomando**

- Aeratore anticalcare M 22 x 1
- Scarico 1 1/4" con sistema brevettato SNAP
- Flessibili inox ø 3/8"

Cromo lucido	GRC5119/6CR	295,00 €
Miele spazzolato PVD	GRC5119/6CGP	<b>NEW</b> 472,00 €



RVT200/5D  
18,00 €



RAE219/61CR  
23,00 € - 1 pz.

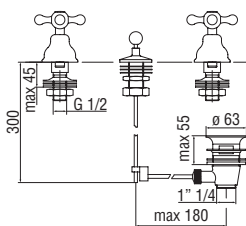

**Batteria 3 fori**

- Scarico 1 1/4" con sistema brevettato SNAP
- Erogazione dalla brida

Cromo lucido	GRC5015/1CR	200,00 €
Miele spazzolato PVD	GRC5015/1CGP	<b>NEW</b> 320,00 €



RVT200/5D  
18,00 €



NR00212/1  
19,00 €

VASCA A PAVIMENTO

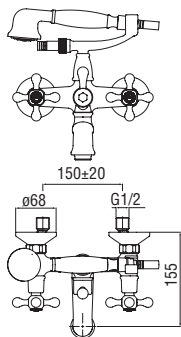
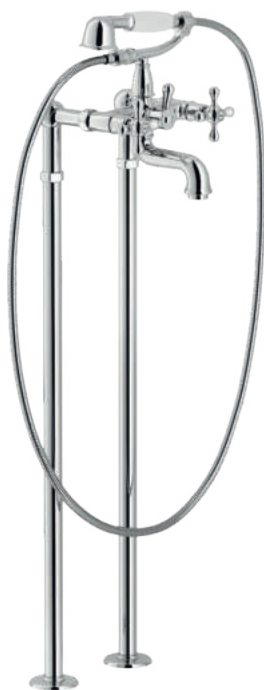

**Gruppo esterno con set doccia**

- Aeratore anticalcare M 28 x 1
- Deviatore manuale
- Doccetta monogetto e flessibile 150 cm

Cromo lucido	GRC5001CR	387,00 €
Miele spazzolato PVD	GRC5001CGP	<b>NEW</b> 619,00 €



RVT200/5D  
18,00 €



RAEK219/41CR  
47,00 € - 5 pz.

**Colonne a pavimento**

- Attacco ø 3/4" x 1/2"

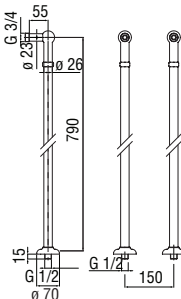

Cromo lucido	AV00151/10CR	641,00 €
Miele spazzolato PVD	AV00151/10CGP	<b>NEW</b> 1.026,00 €

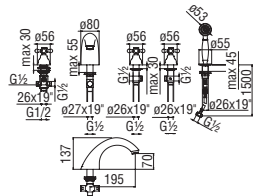

### Batteria 5 fori bordo vasca

- Aeratore anticalcare M 28 x 1
- Deviatore a 2 vie
- Doccetta monogetto estraibile

Cromo lucido	WEBK204/GRCR	907,00 €
Miele spazzolato PVD	WEBK204/GRCGP	<b>NEW</b> 1.451,00 €



VASCA

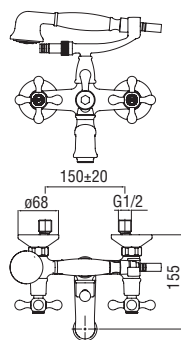

### Gruppo esterno con set doccia

- Aeratore anticalcare M 28 x 1
- Deviatore manuale
- Doccetta monogetto e flessibile 150 cm

Cromo lucido	GRC5001CR	387,00 €
Miele spazzolato PVD	GRC5001CGP	<b>NEW</b> 619,00 €

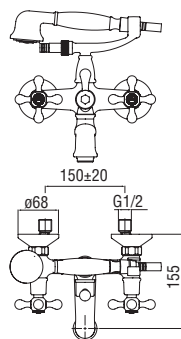

### Gruppo esterno con set doccia

- Aeratore anticalcare M 28 x 1
- Deviatore manuale
- Doccetta monogetto e flessibile 150 cm

Cromo lucido	GRC5001CR	387,00 €
Miele spazzolato PVD	GRC5001CGP	<b>NEW</b> 619,00 €



### Colonna con rampa telescopica

- Attacco presa acqua
- Soffione a snodo ø 200 mm
- Supporto doccetta orientabile
- Flessibile di raccordo 50 cm

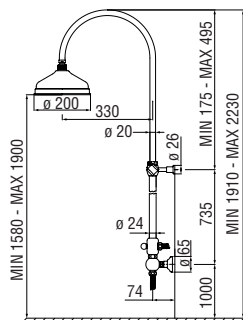

Cromo lucido	AD141/10CR	920,00 €
Miele spazzolato PVD	AD141/10CGP	<b>NEW</b> 1.472,00 €

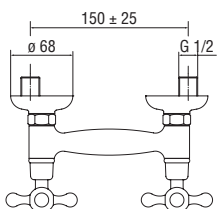
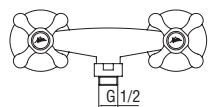
**Gruppo esterno**

· Uscita ø 1/2"

Cromo lucido	GRC5003/ICR	182,00 €
Miele spazzolato PVD	GRC5003/ICGP	<b>NEW</b> 291,00 €

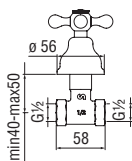
RVT200/5D  
18,00 €**Rubinetto d'arresto a incasso**

· Ingresso a 1 via

· Uscita ø 1/2"

· Placchette acqua calda / fredda incluse nella confezione

Cromo lucido	GRC5008/ICR	82,00 €
Miele spazzolato PVD	GRC5008/ICGP	<b>NEW</b> 131,00 €

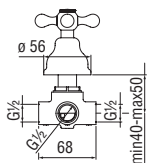
RVT200/5D  
18,00 €NR00212/1  
19,00 €**Deviatore a 2 vie**

· Ingresso a 2 vie

· Uscite ø 1/2"

Cromo lucido	GRO516OCR	258,00 €
Miele spazzolato PVD	GRO516OCGP	<b>NEW</b> 413,00 €

RCR201/45  
21,00 €

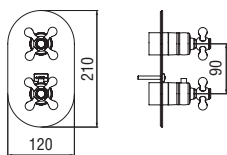

**Parte esterna termostatico a 1 via**

- Blocco di sicurezza 38° C
- Montaggio verticale o orizzontale

Cromo lucido	GRC5101CR	442,00 €
Miele spazzolato PVD	GRC5101CGP	<b>NEW</b> 707,00 €

NR00008  
34,00 €

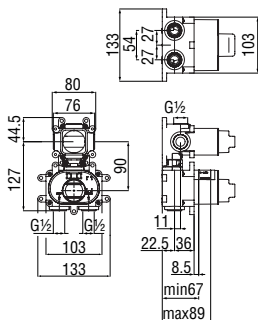

**Wellbox 1 via, parte incasso necessaria**

- Ingresso e uscita acqua  $\varnothing$  1/2"
- Rubinetti di chiusura
- Valvole antiritorno
- Adatta anche a montaggio su cartongesso
- Filtri di ricambio cartuccia inclusi nella confezione

-	WE00101	167,00 €
---	---------	----------

RCR201/5  
58,00 €

RVT200/5D  
18,00 €

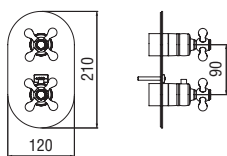

**Parte esterna termostatico a 2 vie**

- Blocco di sicurezza 38° C
- Montaggio verticale o orizzontale

Cromo lucido	GRC5102CR	442,00 €
Miele spazzolato PVD	GRC5102CGP	<b>NEW</b> 707,00 €

NR00008  
34,00 €

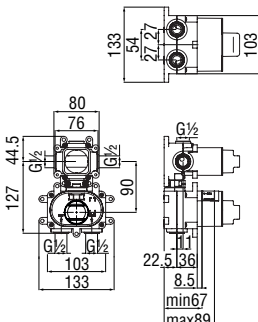

**Wellbox 2 vie, parte incasso necessaria**

- Ingresso e uscita acqua  $\varnothing$  1/2"
- Rubinetti di chiusura
- Valvole antiritorno
- Adatta anche a montaggio su cartongesso
- Filtri di ricambio cartuccia inclusi nella confezione

-	WE00102	215,00 €
---	---------	----------

RCR201/5  
58,00 €

RCR201/28  
39,00 €

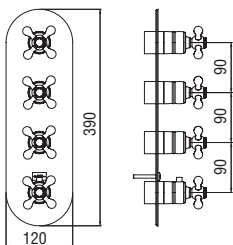

**Parte esterna termostatico a 3 vie**

- Blocco di sicurezza 38° C
- Montaggio verticale o orizzontale

Cromo lucido	GRC5103CR	884,00 €
Miele spazzolato PVD	GRC5103CGP	<b>NEW</b> 1.414,00 €

  
NR00008  
34,00 €

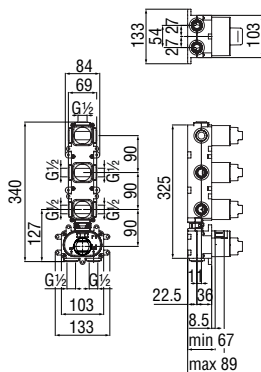

**Wellbox 3 vie, parte incasso necessaria**

- Ingresso e uscita acqua  $\varnothing$  1/2"
- Rubinetti di chiusura
- Valvole antiritorno
- Adatta anche a montaggio su cartongesso
- Filtri di ricambio cartuccia inclusi nella confezione

-	WE00103	318,00 €
---	---------	----------

  
RCR201/5  
58,00 €

  
RVT200/5D  
18,00 €

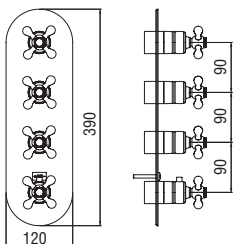

**Parte esterna termostatico a 4 vie**

- Blocco di sicurezza 38° C
- Montaggio verticale o orizzontale

Cromo lucido	GRC5104CR	884,00 €
Miele spazzolato PVD	GRC5104CGP	<b>NEW</b> 1.414,00 €

  
NR00008  
34,00 €

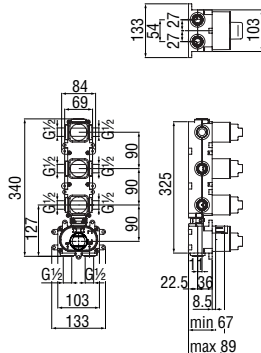

**Wellbox 4 vie, parte incasso necessaria**

- Ingresso e uscita acqua  $\varnothing$  1/2"
- Rubinetti di chiusura
- Valvole antiritorno
- Adatta anche a montaggio su cartongesso
- Filtri di ricambio cartuccia inclusi nella confezione

-	WE00104	360,00 €
---	---------	----------

  
RCR201/5  
58,00 €

  
RCR201/28  
39,00 €

  
RVT200/5D  
18,00 €





RUBINETTERIA ENNE DI NOBILI

# BLUES

Centro Stile Nobili

Geometrie estroverse e cuore brillante dialogano alla pari. Un incontro tra linee pure ed espressive per celebrare la migliore ergonomia, audace sintesi dell'elemento acqua, attraverso un gesto fortemente espressivo: la cartuccia a immersione totale Nobili Widd® è garanzia di assoluta affidabilità e massima sostenibilità ambientale.

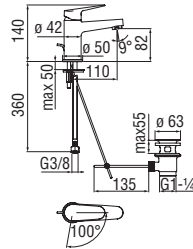

Cromo lucido

**Monocomando a risparmio idrico ed energetico**

- Limitatore di energia con apertura in acqua fredda
- Aeratore anticalcare M 24 x 1, portata 5 l/min
- Scarico 1 1/4" con sistema brevettato SNAP
- Flessibili inox  $\varnothing$  3/8"

Cromo lucido BSH101118/1CR 84,00 €

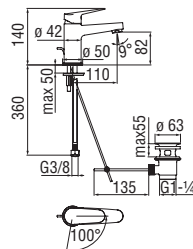
CARTRIDGE  
WARRANTYRCR350/ECO  
48,00 €RAEK219/23CR  
61,00 € - 10 pz.**Monocomando a risparmio idrico ed energetico**

- Limitatore di energia con apertura in acqua fredda
- Aeratore anticalcare M 24 x 1, portata 5 l/min
- Scarico 1 1/4" in PVC
- Flessibili inox  $\varnothing$  3/8"

Cromo lucido BSH101118/4CR 84,00 €

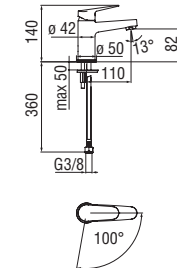
CARTRIDGE  
WARRANTYRCR350/ECO  
48,00 €RAEK219/23CR  
61,00 € - 10 pz.**Monocomando a risparmio idrico ed energetico**

- Limitatore di energia con apertura in acqua fredda
- Aeratore anticalcare M 24 x 1, portata 5 l/min
- Senza scarico
- Flessibili inox  $\varnothing$  3/8"

Cromo lucido BSH101118/3CR 81,00 €

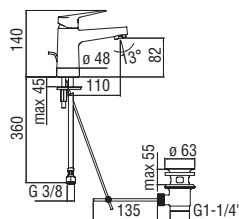
CARTRIDGE  
WARRANTYRCR350/ECO  
48,00 €RAEK219/23CR  
61,00 € - 10 pz.**Monocomando**

- Limitatore di portata con freno al 50%
- Aeratore anticalcare M 24 x 1
- Scarico 1 1/4" con sistema brevettato SNAP
- Flessibili inox  $\varnothing$  3/8"

Cromo lucido BS101118/1CR 84,00 €

CARTRIDGE  
WARRANTYRCR350/D  
39,00 €RAEK220/32CR  
45,00 € - 10 pz.

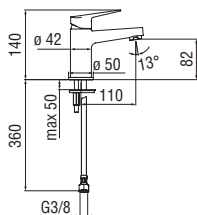
**Monocomando**

- Limitatore di portata con freno al 50%
- Aeratore anticalcare M 24 x 1
- Senza scarico
- Flessibili inox  $\varnothing$  3/8"

Cromo lucido

BS101118/3CR

81,00 €

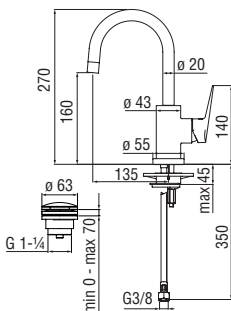
CARTRIDGE  
WARRANTYRCR350/D  
39,00 €RAEK220/32CR  
45,00 € - 10 pz.**Monocomando**

- Limitatore di portata con freno al 50%
- Aeratore anticalcare M 16 x 1
- Bocca girevole 360°
- Scarico 1 1/4" push
- Flessibili inox  $\varnothing$  3/8"

Cromo lucido

BS101338/2CR

292,00 €

CARTRIDGE  
WARRANTYRCR360/D  
39,00 €RAEK222/10CR  
58,00 € - 10 pz.

## BIDET

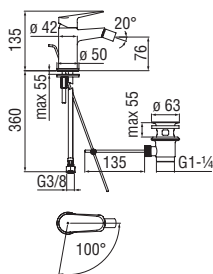
**Monocomando a risparmio idrico ed energetico**

- Limitatore di energia con apertura in acqua fredda
- Aeratore anticalcare M 16,5 x 1, portata 5 l/min
- Getto orientabile
- Scarico 1 1/4" con sistema brevettato SNAP
- Flessibili inox  $\varnothing$  3/8"

Cromo lucido

BSH101119/1CR

84,00 €

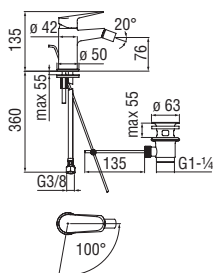
CARTRIDGE  
WARRANTYRCR350/ECO  
48,00 €RAE219/28CR  
22,00 € - 1 pz.**Monocomando a risparmio idrico ed energetico**

- Limitatore di energia con apertura in acqua fredda
- Aeratore anticalcare M 16,5 x 1, portata 5 l/min
- Getto orientabile
- Scarico 1 1/4" in PVC
- Flessibili inox  $\varnothing$  3/8"

Cromo lucido

BSH101119/4CR

84,00 €

CARTRIDGE  
WARRANTYRCR350/ECO  
48,00 €RAE219/28CR  
22,00 € - 1 pz.

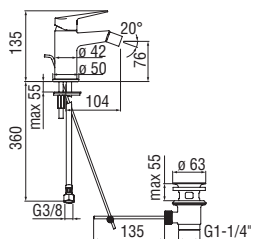

**Monocomando**

- Limitatore di portata con freno al 50%
- Aeratore anticalcare M 16,5 x 1
- Getto orientabile
- Scarico 1 1/4" con sistema brevettato SNAP
- Flessibili inox ø 3/8"

Cromo lucido BS101119/1CR 84,00 €



CARTRIDGE WARRANTY



RCR350/D 39,00 €



RAEK222/25CR 21,00 € - 1 pz.

VASCA

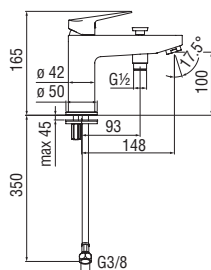

**Monocomando**

- Limitatore di portata con freno al 50%
- Aeratore anticalcare M 24 x 1
- Deviatore con ritorno automatico
- Valvole antiritorno
- Uscita ø 1/2"

Cromo lucido BS101118/10CR 166,00 €



CARTRIDGE WARRANTY



RCR350/D 39,00 €



RAEK220/14CR 45,00 € - 10 pz.

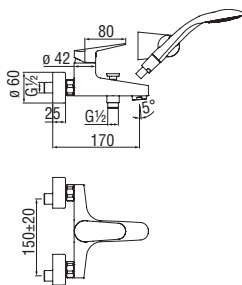

**Monocomando esterno con set doccia**

- Limitatore di portata con freno al 50%
- Aeratore anticalcare M 28 x 1
- Deviatore con ritorno automatico
- Supporto doccetta orientabile
- Doccetta monogetto e flessibile 150 cm

Cromo lucido BS101110CR 154,00 €



CARTRIDGE WARRANTY



RCR350/D 39,00 €



RAEK219/4CR 43,00 € - 5 pz.

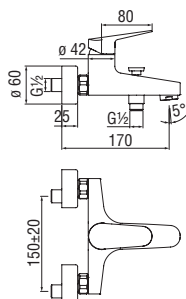

**Monocomando esterno**

- Limitatore di portata con freno al 50%
- Aeratore anticalcare M 28 x 1
- Deviatore con ritorno automatico
- Uscita ø 1/2"

Cromo lucido BS101110/1CR 129,00 €



CARTRIDGE WARRANTY



RCR350/D 39,00 €

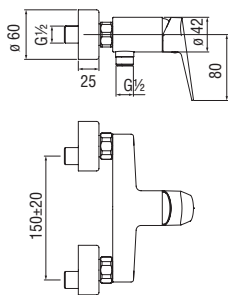

RAEK219/4CR 43,00 € - 5 pz.

**Monocomando esterno**

- Limitatore di portata con freno al 50%
- Uscita ø 1/2"

Cromo lucido BS101130CR 103,00 €

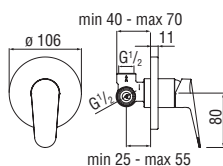
CARTRIDGE  
WARRANTYRCR350  
39,00 €**Monocomando incasso a 1 via**

- Limitatore di portata con freno al 50%
- Ingresso acqua calda e acqua fredda ø 1/2"
- Uscita ø 1/2"
- Parte esterna e parte incasso

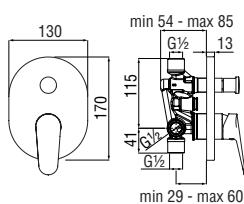
Cromo lucido BS101108CR **MOD** 62,00 €CARTRIDGE  
WARRANTYRCR350  
39,00 €NR00212/10CR  
43,00 €**Monocomando incasso a 2 vie**

- Limitatore di portata con freno al 50%
- Ingresso acqua calda e acqua fredda ø 1/2"
- Uscite ø 1/2"
- Deviatore con ritorno automatico
- Parte esterna e parte incasso

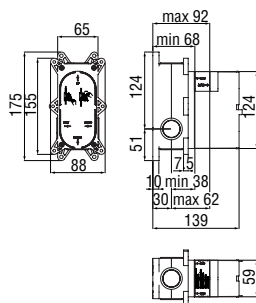
Cromo lucido BS101100CR **MOD** 138,00 €CARTRIDGE  
WARRANTYRCR350  
39,00 €NR00212/13CR  
57,00 €**Scatola opzionale**

- Per montaggio su cartongesso

- WE81100/SC 67,00 €



RUBINETTERIA ENNE DI NOBILI

# ABC

Centro Stile Nobili

Risveglio lento, la luce gentile del mattino, l'abbraccio di una doccia fresca. Un saluto al nuovo giorno in barca a vela, sedotti dal profumo del mare, cullati dalla brezza verso l'infinito. Benessere interiore nel totale rispetto ambientale: la cartuccia a immersione Nobili Widd® è garanzia di assoluta affidabilità e massima sostenibilità.

Nota: articoli in finitura Mora opaco acquistabili solo su confezione



Cromo lucido

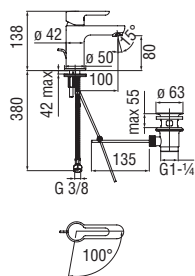

Mora opaco

**Monocomando a risparmio idrico ed energetico**

- Limitatore di energia con apertura in acqua fredda
- Aeratore anticalcare M 24 x 1, portata 5 l/min
- Scarico 1 1/4" con sistema brevettato SNAP
- Flessibili inox  $\varnothing$  3/8"

Cromo lucido	ABH87118/1CR	96,00 €
Mora opaco	ABH87118/1BM	<b>NEW</b> 130,00 €



CARTRIDGE  
WARRANTY



RCR350/ECO  
48,00 €

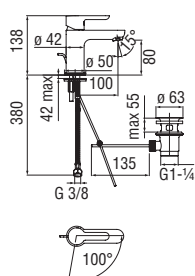

RAEK219/23CR  
61,00 € - 10 pz.

**Monocomando a risparmio idrico ed energetico**

- Limitatore di energia con apertura in acqua fredda
- Aeratore anticalcare M 24 x 1, portata 5 l/min
- Scarico 1 1/4" in PVC
- Flessibili inox  $\varnothing$  3/8"

Cromo lucido	ABH87118/4CR	96,00 €
Mora opaco	ABH87118/4BM	<b>NEW</b> 130,00 €



CARTRIDGE  
WARRANTY



RCR350/ECO  
48,00 €

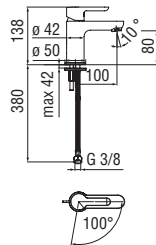

RAEK219/23CR  
61,00 € - 10 pz.

**Monocomando a risparmio idrico ed energetico**

- Limitatore di energia con apertura in acqua fredda
- Aeratore anticalcare M 24 x 1, portata 5 l/min
- Senza scarico
- Flessibili inox  $\varnothing$  3/8"

Cromo lucido	ABH87118/2CR	92,00 €
Mora opaco	ABH87118/2BM	<b>NEW</b> 124,00 €



CARTRIDGE  
WARRANTY



RCR350/ECO  
48,00 €

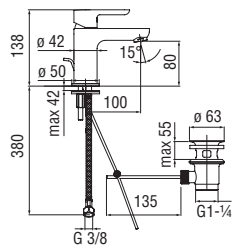

RAEK219/23CR  
61,00 € - 10 pz.

**Monocomando**

- Limitatore di portata con freno al 50%
- Aeratore anticalcare M 24 x 1
- Scarico 1 1/4" con sistema brevettato SNAP
- Flessibili inox  $\varnothing$  3/8"

Cromo lucido	AB87118/1CR	96,00 €
Mora opaco	AB87118/1BM	<b>NEW</b> 130,00 €



CARTRIDGE  
WARRANTY



RCR350/D  
39,00 €



RAEK220/32CR  
45,00 € - 10 pz.

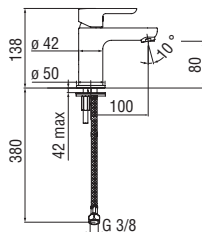

**Monocomando**

- Limitatore di portata con freno al 50%
- Aeratore anticalcare M 24 x 1
- Senza scarico
- Flessibili inox  $\varnothing$  3/8"

Cromo lucido	AB87118/2CR	92,00 €
Mora opaco	AB87118/2BM	<b>NEW</b> 124,00 €



CARTRIDGE  
WARRANTY



RCR350/D  
39,00 €

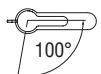
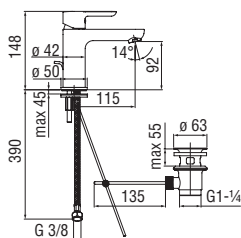

RAEK220/32CR  
45,00 € - 10 pz.

**Monocomando bocca lunga a risparmio idrico ed energetico**

- Limitatore di energia con apertura in acqua fredda
- Aeratore anticalcare M 24 x 1, portata 5 l/min
- Scarico 1 1/4" con sistema brevettato SNAP
- Flessibili inox  $\varnothing$  3/8"

Cromo lucido	ABH87118/20CR	146,00 €
Mora opaco	ABH87118/20BM	<b>NEW</b> 197,00 €



CARTRIDGE  
WARRANTY



RCR350/ECO  
48,00 €

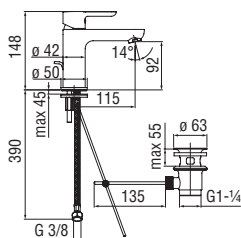

RAEK219/23CR  
61,00 € - 10 pz.

**Monocomando bocca lunga**

- Limitatore di portata con freno al 50%
- Aeratore anticalcare M 24 x 1
- Scarico 1 1/4" con sistema brevettato SNAP
- Flessibili inox  $\varnothing$  3/8"

Cromo lucido	AB87118/20CR	146,00 €
Mora opaco	AB87118/20BM	<b>NEW</b> 197,00 €



CARTRIDGE  
WARRANTY



RCR350/D  
39,00 €

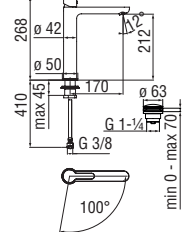

RAEK220/32CR  
45,00 € - 10 pz.

**Monocomando a bacinella a risparmio idrico ed energetico**

- Limitatore di energia con apertura in acqua fredda
- Aeratore anticalcare M 24 x 1, portata 5 l/min
- Scarico 1 1/4" push
- Flessibili inox  $\varnothing$  3/8"

Cromo lucido	ABH87128/2CR	199,00 €
Mora opaco	ABH87128/2BM	<b>NEW</b> 269,00 €



CARTRIDGE  
WARRANTY



RCR350/ECO  
48,00 €

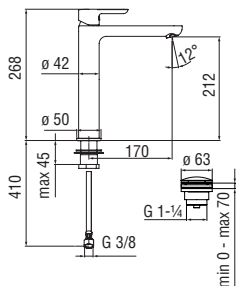

RAEK219/23CR  
61,00 € - 10 pz.

**Monocomando a bacinella**

- Limitatore di portata con freno al 50%
- Aeratore anticalcare M 24 x 1
- Scarico 1 1/4" push
- Flessibili inox ø 3/8"

Cromo lucido	AB87128/2CR	199,00 €
Mora opaco	AB87128/2BM	<b>NEW</b> 269,00 €



CARTRIDGE  
WARRANTY



RCR350/D  
39,00 €

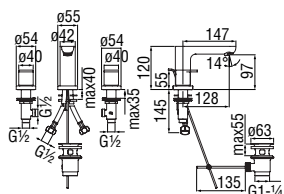

RAEK220/32CR  
45,00 € - 10 pz.

**Batteria 3 fori**

- Aeratore anticalcare M 24 x 1
- Scarico 1 1/4" con sistema brevettato SNAP

Cromo lucido	AB87211/1CR	245,00 €
Mora opaco	AB87211/1BM	<b>NEW</b> 331,00 €



RVT200/5D  
18,00 €

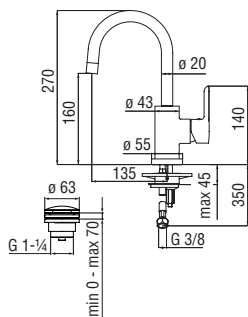

RAEK220/32CR  
45,00 € - 10 pz.

**Monocomando**

- Limitatore di portata con freno al 50%
- Aeratore anticalcare M 22 x 1
- Bocca girevole 360°
- Scarico 1 1/4" push
- Flessibili inox ø 3/8"

Cromo lucido	AB87338/2CR	295,00 €
Mora opaco	AB87338/2BM	<b>NEW</b> 398,00 €



CARTRIDGE  
WARRANTY



RCR360/D  
39,00 €

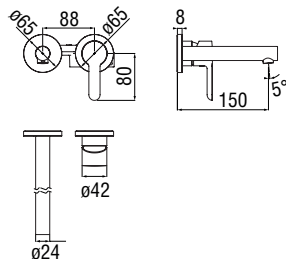

RAEK222/10CR  
58,00 € - 10 pz.

**Parte esterna monocomando a parete**

- Limitatore di portata con freno al 50%
- Aeratore anticalcare M 18 x 1
- Lunghezza bocca 150 mm
- Senza scarico

Cromo lucido	AB87199CR	217,00 €
Mora opaco	AB87199BM	<b>NEW</b> 293,00 €



RAEK220/27CR  
43,00 € - 10 pz.

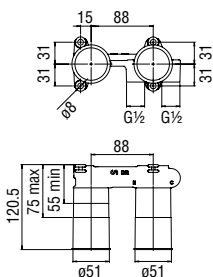

NR00212/10CR  
43,00 €

**Allbox, parte incasso necessaria**

- Ingresso acqua calda e acqua fredda ø 1/2"
- Uscita ø 1/2"

-	WE00198	<b>MOD</b>	125,00 €
---	---------	------------	----------



CARTRIDGE  
WARRANTY

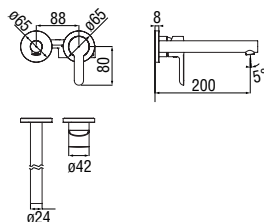

RCR350  
39,00 €

**Parte esterna monocomando a parete bocca lunga**

- Limitatore di portata con freno al 50%
- Aeratore anticalcare M 18 x 1
- Lunghezza bocca 200 mm
- Senza scarico

Cromo lucido	AB87199/1CR	245,00 €
Mora opaco	AB87199/1BM	<b>NEW</b> 331,00 €



RAEK220/27CR  
43,00 € - 10 pz.

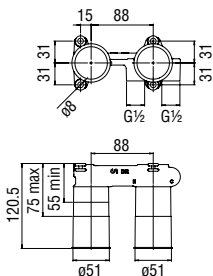

NR00212/10CR  
43,00 €

**Allbox, parte incasso necessaria**

- Ingresso acqua calda e acqua fredda ø 1/2"
- Uscita ø 1/2"

-	WE00198	<b>MOD</b>	125,00 €
---	---------	------------	----------



CARTRIDGE  
WARRANTY

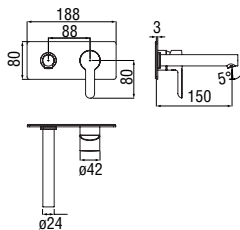

RCR350  
39,00 €

**Parte esterna monocomando a parete**

- Limitatore di portata con freno al 50%
- Aeratore anticalcare M 18 x 1
- Lunghezza bocca 150 mm
- Senza scarico

Cromo lucido	AB87198CR	236,00 €
Mora opaco	AB87198BM	<b>NEW</b> 319,00 €



RAEK220/27CR  
43,00 € - 10 pz.

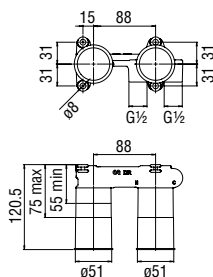

NR00212/10CR  
43,00 €

**Allbox, parte incasso necessaria**

- Ingresso acqua calda e acqua fredda  $\varnothing$  1/2"
- Uscita  $\varnothing$  1/2"

-	WE00198	<b>MOD</b> 125,00 €
---	---------	---------------------



CARTRIDGE  
WARRANTY

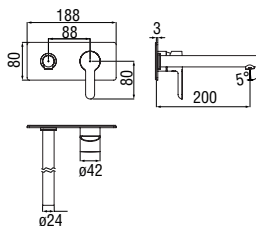

RCR350  
39,00 €

**Parte esterna monocomando a parete bocca lunga**

- Limitatore di portata con freno al 50%
- Aeratore anticalcare M 18 x 1
- Lunghezza bocca 200 mm
- Senza scarico

Cromo lucido	AB87198/1CR	261,00 €
Mora opaco	AB87198/1BM	<b>NEW</b> 352,00 €



RAEK220/27CR  
43,00 € - 10 pz.

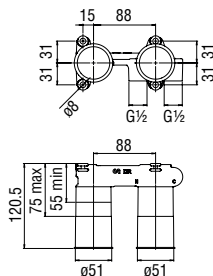

NR00212/10CR  
43,00 €

**Allbox, parte incasso necessaria**

- Ingresso acqua calda e acqua fredda  $\varnothing$  1/2"
- Uscita  $\varnothing$  1/2"

-	WE00198	<b>MOD</b> 125,00 €
---	---------	---------------------



CARTRIDGE  
WARRANTY



RCR350  
39,00 €

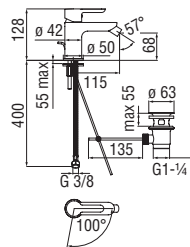

**Monocomando a risparmio idrico ed energetico**

- Limitatore di energia con apertura in acqua fredda
- Aeratore anticalcare M 16,5 x 1, portata 5 l/min
- Getto orientabile
- Scarico 1 1/4" con sistema brevettato SNAP
- Flessibili inox ø 3/8"

Cromo lucido	ABH87119/1CR	96,00 €
Mora opaco	ABH87119/1BM	<b>NEW</b> 130,00 €

<b>20 YEARS</b> CARTRIDGE WARRANTY	RCR350/ECO 48,00 €	RAE219/28CR 22,00 € - 1 pz.
---------------------------------------	-----------------------	--------------------------------

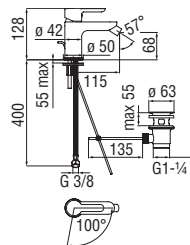

**Monocomando a risparmio idrico ed energetico**

- Limitatore di energia con apertura in acqua fredda
- Aeratore anticalcare M 16,5 x 1, portata 5 l/min
- Getto orientabile
- Scarico 1 1/4" in PVC
- Flessibili inox ø 3/8"

Cromo lucido	ABH87119/4CR	96,00 €
Mora opaco	ABH87119/4BM	<b>NEW</b> 130,00 €

<b>20 YEARS</b> CARTRIDGE WARRANTY	RCR350/ECO 48,00 €	RAE219/28CR 22,00 € - 1 pz.
---------------------------------------	-----------------------	--------------------------------

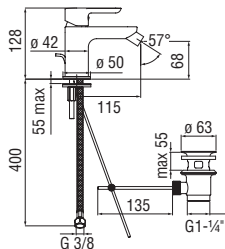

**Monocomando**

- Limitatore di portata con freno al 50%
- Aeratore anticalcare M 16,5 x 1
- Getto orientabile
- Scarico 1 1/4" con sistema brevettato SNAP
- Flessibili inox ø 3/8"

Cromo lucido	AB87119/1CR	96,00 €
Mora opaco	AB87119/1BM	<b>NEW</b> 130,00 €

<b>20 YEARS</b> CARTRIDGE WARRANTY	RCR350/D 39,00 €	RAE222/25CR 21,00 € - 1 pz.
---------------------------------------	---------------------	--------------------------------

BORDO VASCA

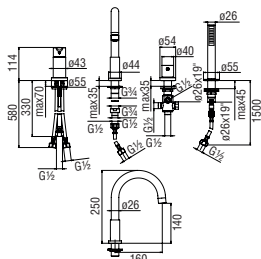

**Monocomando bordo vasca**

- Limitatore di portata con freno al 50%
- Aeratore anticalcare M 24 x 1
- Deviatore a 2 vie
- Doccetta monogetto estraibile

Cromo lucido	WEBK110/9ABCR	662,00 €
Mora opaco	WEBK110/9ABBM	<b>NEW</b> 894,00 €

<b>20 YEARS</b> CARTRIDGE WARRANTY	RCR350 39,00 €	RAEK219/43CR 38,00 € - 5 pz.
---------------------------------------	-------------------	---------------------------------

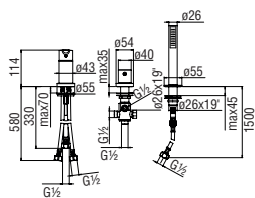

### Monocomando bordo vasca

- Limitatore di portata con freno al 50%
- Deviatore a 2 vie
- Doccetta monogetto estraibile
- Erogazione dalla colonna vasca

Cromo lucido	WEBK110/6ABCR	473,00 €
Mora opaco	WEBK110/6ABBM	<b>NEW</b> 639,00 €



CARTRIDGE  
WARRANTY



RCR350  
39,00 €

## VASCA

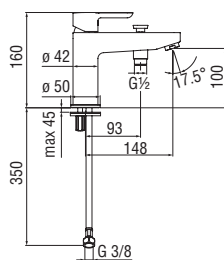

### Monocomando

- Limitatore di portata con freno al 50%
- Aeratore anticalcare M 24 x 1
- Deviatore con ritorno automatico
- Valvole antiritorno
- Uscita ø 1/2"

Cromo lucido	AB87118/10CR	179,00 €
Mora opaco	AB87118/10BM	<b>NEW</b> 242,00 €



CARTRIDGE  
WARRANTY



RCR350/D  
39,00 €



RAEK220/14CR  
45,00 € - 10 pz.

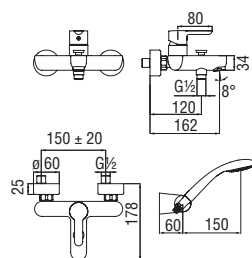

### Monocomando esterno con set doccia

- Limitatore di portata con freno al 50%
- Aeratore anticalcare M 28 x 1
- Deviatore con ritorno automatico
- Supporto doccetta orientabile
- Doccetta monogetto e flessibile 150 cm

Cromo lucido	AB87110CR	182,00 €
Mora opaco	AB87110BM	<b>NEW</b> 246,00 €



CARTRIDGE  
WARRANTY



RCR360/D  
39,00 €



RAEK219/4CR  
43,00 € - 5 pz.

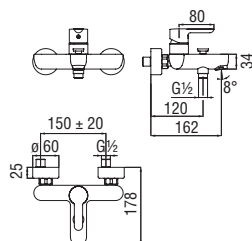

### Monocomando esterno

- Limitatore di portata con freno al 50%
- Aeratore anticalcare M 28 x 1
- Deviatore con ritorno automatico
- Uscita ø 1/2"

Cromo lucido	AB87110/1CR	158,00 €
Mora opaco	AB87110/1BM	<b>NEW</b> 213,00 €



CARTRIDGE  
WARRANTY



RCR360/D  
39,00 €



RAEK219/4CR  
43,00 € - 5 pz.

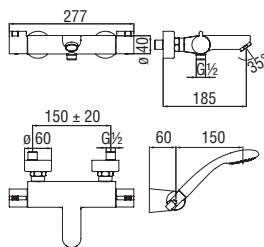

**Termostatico esterno con set doccia**

- Blocco di sicurezza 38° C
- Valvoline antiritorno
- Aeratore anticalcare M 28 x 1
- Deviatore a 2 vie ceramico
- Supporto doccetta orientabile
- Doccetta monogetto e flessibile 150 cm
- Filtri di ricambio cartuccia inclusi nella confezione

Cromo lucido	AB87010CR	333,00 €
Mora opaco	AB87010BM	<b>NEW</b> 450,00 €



RCR201/5  
58,00 €



RCR201/70  
39,00 €



RAEK219/4CR  
43,00 € - 5 pz.

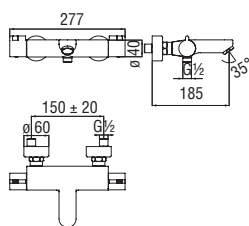

**Termostatico esterno**

- Blocco di sicurezza 38° C
- Valvoline antiritorno
- Sistema anticalcare
- Aeratore anticalcare M 28 x 1
- Deviatore a 2 vie ceramico
- Uscita ø 1/2"
- Filtri di ricambio cartuccia inclusi nella confezione

Cromo lucido	AB87010/1CR	308,00 €
Mora opaco	AB87010/1BM	<b>NEW</b> 416,00 €



RCR201/5  
58,00 €



RCR201/70  
39,00 €



RAEK219/4CR  
43,00 € - 5 pz.

DOCCIA

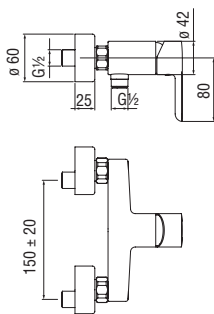

**Monocomando esterno**

- Limitatore di portata con freno al 50%
- Uscita ø 1/2"

Cromo lucido	AB87130CR	130,00 €
Mora opaco	AB87130BM	<b>NEW</b> 175,00 €



20  
YEARS  
CARTRIDGE  
WARRANTY



RCR350  
39,00 €

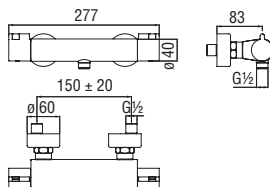

**Termostatico esterno**

- Blocco di sicurezza 38° C
- Valvoline antiritorno
- Sistema anticalcare
- Uscita ø 1/2"
- Filtri di ricambio cartuccia inclusi nella confezione

Cromo lucido	AB87030CR	222,00 €
Mora opaco	AB87030BM	<b>NEW</b> 300,00 €



RCR201/6  
58,00 €

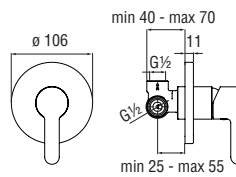

RVT200/26  
18,00 €

**Monocomando incasso a 1 via**

- Limitatore di portata con freno al 50%
- Ingresso acqua calda e acqua fredda  $\varnothing$  1/2"
- Uscita  $\varnothing$  1/2"
- Parte esterna e parte incasso

Cromo lucido	AB87108CR	<b>MOD</b>	67,00 €
Mora opaco	AB87108BM	<b>NEW</b>	90,00 €



CARTRIDGE  
WARRANTY



RCR350  
39,00 €

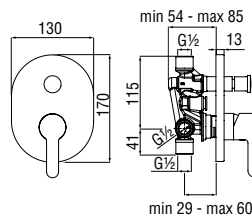

NR00212/10CR  
43,00 €

**Monocomando incasso a 2 vie**

- Limitatore di portata con freno al 50%
- Ingresso acqua calda e acqua fredda  $\varnothing$  1/2"
- Uscite  $\varnothing$  1/2"
- Deviatore con ritorno automatico
- Parte esterna e parte incasso

Cromo lucido	AB87100CR	<b>MOD</b>	149,00 €
Mora opaco	AB87100BM	<b>NEW</b>	201,00 €



CARTRIDGE  
WARRANTY



RCR350  
39,00 €



NR00212/13CR  
57,00 €

**Scatola opzionale**

- Per montaggio su cartongesso

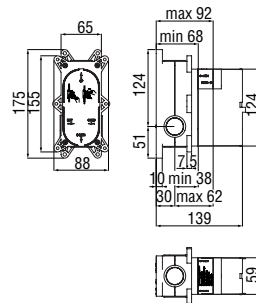

-	WE81100/SC		67,00 €
---	------------	--	---------



RUBINETTERIA ENNE DI NOBILI

# NOBI

Centro Stile Nobili

Pura tradizione Nobili: linea equilibrata ed efficienza tecnologica, nel rispetto del DNA del nostro brand. Look candido e luminoso, che suggerisce uno stile di vita sano in totale armonia con se stessi e con l'ambiente circostante: la cartuccia a immersione totale Nobili Widd® è garanzia di assoluta affidabilità e massima sostenibilità.

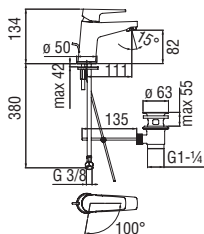

Cromo lucido

**Monocomando a risparmio idrico ed energetico**

- Limitatore di energia con apertura in acqua fredda
- Aeratore anticalcare M 24 x 1, portata 5 l/min
- Scarico 1 1/4" con sistema brevettato SNAP
- Flessibili inox  $\varnothing$  3/8"

Cromo lucido NBH84118/1CR 108,00 €

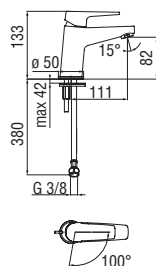
CARTRIDGE  
WARRANTYRCR350/ECO  
48,00 €RAEK219/23CR  
61,00 € - 10 pz.**Monocomando a risparmio idrico ed energetico**

- Limitatore di energia con apertura in acqua fredda
- Aeratore anticalcare M 24 x 1, portata 5 l/min
- Senza scarico
- Flessibili inox  $\varnothing$  3/8"

Cromo lucido NBH84118/2CR 105,00 €

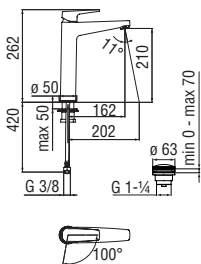
CARTRIDGE  
WARRANTYRCR350/ECO  
48,00 €RAEK219/23CR  
61,00 € - 10 pz.**Monocomando a bacinella a risparmio idrico ed energetico**

- Limitatore di energia con apertura in acqua fredda
- Aeratore anticalcare M 24 x 1, portata 5 l/min
- Scarico 1 1/4" push
- Flessibili inox  $\varnothing$  3/8"

Cromo lucido NBH84128/2CR 290,00 €

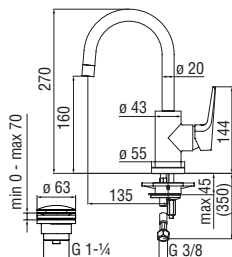
CARTRIDGE  
WARRANTYRCR350/ECO  
48,00 €RAEK219/23CR  
61,00 € - 10 pz.**Monocomando**

- Limitatore di portata con freno al 50%
- Aeratore anticalcare M 16 x 1
- Bocca girevole 360°
- Scarico 1 1/4" push
- Flessibili inox  $\varnothing$  3/8"

Cromo lucido NBH84338/2CR 332,00 €

CARTRIDGE  
WARRANTYRCR360/D  
39,00 €RAEK222/10CR  
58,00 € - 10 pz.

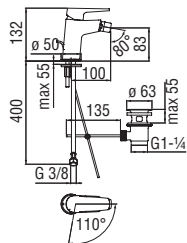

**Monocomando a risparmio idrico ed energetico**

- Limitatore di energia con apertura in acqua fredda
- Aeratore anticalcare M 22 x 1, portata 5 l/min
- Getto orientabile
- Scarico 1 1/4" con sistema brevettato SNAP
- Flessibili inox ø 3/8"

Cromo lucido NBH84119/1CR 108,00 €



CARTRIDGE WARRANTY



RCR350/ECO 48,00 €



RAEK219/22CR 22,00 € - 1 pz.

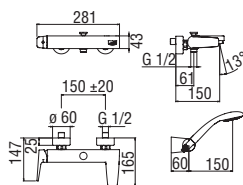

**Monocomando esterno con set doccia**

- Limitatore di portata con freno al 50%
- Aeratore anticalcare M 28 x 1
- Deviatore con ritorno automatico
- Supporto doccetta orientabile
- Doccetta monogetto e flessibile 150 cm

Cromo lucido NBH84110CR 193,00 €



CARTRIDGE WARRANTY



RCR350 39,00 €



RAEK219/4CR 43,00 € - 5 pz.

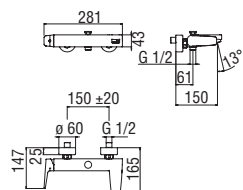

**Monocomando esterno**

- Limitatore di portata con freno al 50%
- Aeratore anticalcare M 28 x 1
- Deviatore con ritorno automatico
- Uscita ø 1/2"

Cromo lucido NBH84110/1CR 170,00 €



CARTRIDGE WARRANTY



RCR350 39,00 €



RAEK219/4CR 43,00 € - 5 pz.

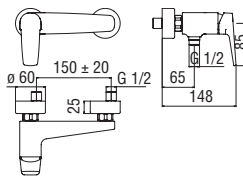

**Monocomando esterno**

- Limitatore di portata con freno al 50%
- Uscita ø 1/2"

Cromo lucido NBH84130CR 140,00 €



CARTRIDGE WARRANTY



RCR350/D 39,00 €

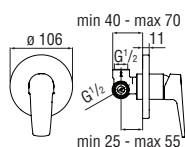

### Monocomando incasso a 1 via

- Limitatore di portata con freno al 50%
- Ingresso acqua calda e acqua fredda  $\varnothing$  1/2"
- Uscita  $\varnothing$  1/2"
- Parte esterna e parte incasso

Cromo lucido NB84108CR **MOD** 72,00 €



CARTRIDGE  
WARRANTY



RCR350  
39,00 €



NR00212/10CR  
43,00 €

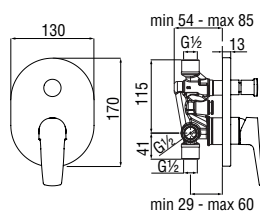

### Monocomando incasso a 2 vie

- Limitatore di portata con freno al 50%
- Ingresso acqua calda e acqua fredda  $\varnothing$  1/2"
- Uscite  $\varnothing$  1/2"
- Deviatore con ritorno automatico
- Parte esterna e parte incasso

Cromo lucido NB84100CR **MOD** 160,00 €



CARTRIDGE  
WARRANTY



RCR350  
39,00 €



NR00212/13CR  
57,00 €

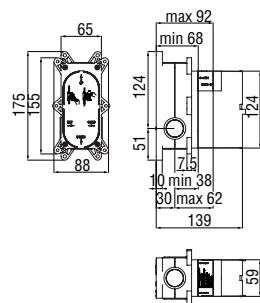

### Scatola opzionale

- Per montaggio su cartongesso

- WE81100/SC 67,00 €

RUBINETTERIA ENNE DI NOBILI

# SAND

Centro Stile Nobili

Architettura semplice e lineare: rilassanti toni pastello vivacizzano l'ambiente domestico. L'acqua sul viso riconcilia con il mondo: il sole chiama, la spiaggia attende. Un abito moderno e lineare veste la più elevata avanguardia tecnologica: la cartuccia a immersione totale Nobili Widd® è garanzia di assoluta affidabilità e massima sostenibilità.

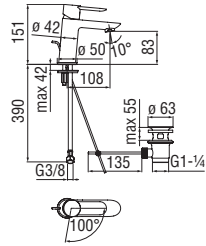

Cromo lucido

**Monocomando a risparmio idrico ed energetico**

- Limitatore di energia con apertura in acqua fredda
- Aeratore anticalcare M 24 x 1, portata 5 l/min
- Scarico 1 1/4" con sistema brevettato SNAP
- Flessibili inox ø 3/8"

Cromo lucido SAH99118/1CR 120,00 €

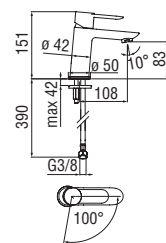
CARTRIDGE  
WARRANTYRCR350/ECO  
48,00 €RAEK219/23CR  
61,00 € - 10 pz.**Monocomando a risparmio idrico ed energetico**

- Limitatore di energia con apertura in acqua fredda
- Aeratore anticalcare M 24 x 1, portata 5 l/min
- Senza scarico
- Flessibili inox ø 3/8"

Cromo lucido SAH99118/2CR 117,00 €

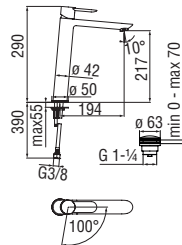
CARTRIDGE  
WARRANTYRCR350/ECO  
48,00 €RAEK219/23CR  
61,00 € - 10 pz.**Monocomando a bacinella a risparmio idrico ed energetico**

- Limitatore di energia con apertura in acqua fredda
- Aeratore anticalcare M 24 x 1, portata 5 l/min
- Scarico 1 1/4" push
- Flessibili inox ø 3/8"

Cromo lucido SAH99128/2CR 282,00 €

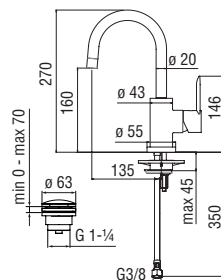
CARTRIDGE  
WARRANTYRCR350/ECO  
48,00 €RAEK219/23CR  
61,00 € - 10 pz.**Monocomando**

- Limitatore di portata con freno al 50%
- Aeratore anticalcare M 16 x 1
- Bocca girevole 360°
- Scarico 1 1/4" push
- Flessibili inox ø 3/8"

Cromo lucido SA99338/2CR 315,00 €

CARTRIDGE  
WARRANTYRCR360/D  
39,00 €RAEK222/10CR  
58,00 € - 10 pz.

BIDET

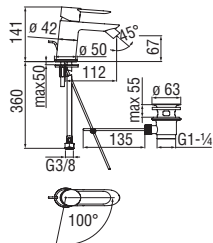

**Monocomando a risparmio idrico ed energetico**

- Limitatore di energia con apertura in acqua fredda
- Aeratore anticalcare M 16,5 x 1, portata 5 l/min
- Getto orientabile
- Scarico 1 1/4" con sistema brevettato SNAP
- Flessibili inox ø 3/8"

Cromo lucido SAH99119/1CR 120,00 €



CARTRIDGE  
WARRANTY



RCR350/ECO  
48,00 €



RAE219/28CR  
22,00 € - 1 pz.

VASCA

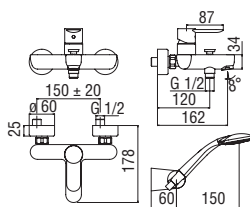

**Monocomando esterno con set doccia**

- Limitatore di portata con freno al 50%
- Aeratore anticalcare M 28 x 1
- Deviatore con ritorno automatico
- Supporto doccetta orientabile
- Doccetta monogetto e flessibile 150 cm

Cromo lucido SA99110CR 205,00 €



CARTRIDGE  
WARRANTY



RCR360/D  
39,00 €



RAEK219/4CR  
43,00 € - 5 pz.

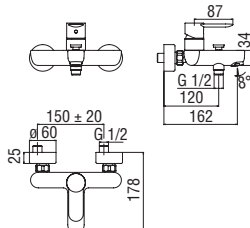

**Monocomando esterno**

- Limitatore di portata con freno al 50%
- Aeratore anticalcare M 28 x 1
- Deviatore con ritorno automatico
- Uscita ø 1/2"

Cromo lucido SA99110/1CR 181,00 €



CARTRIDGE  
WARRANTY



RCR360/D  
39,00 €



RAEK219/4CR  
43,00 € - 5 pz.

DOCCIA

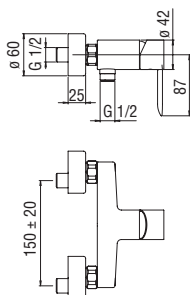

**Monocomando esterno**

- Limitatore di portata con freno al 50%
- Uscita ø 1/2"

Cromo lucido SA99130CR 147,00 €



CARTRIDGE  
WARRANTY

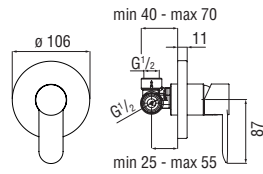

RCR350  
39,00 €

**Monocomando incasso a 1 via**

- Limitatore di portata con freno al 50%
- Ingresso acqua calda e acqua fredda  $\varnothing$  1/2"
- Uscita  $\varnothing$  1/2"
- Parte esterna e parte incasso

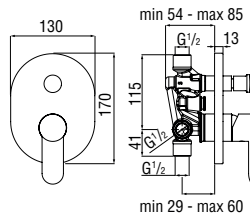
Cromo lucido SA99108CR **MOD** 75,00 €CARTRIDGE  
WARRANTYRCR350  
39,00 €NR00212/10CR  
43,00 €**Monocomando incasso a 2 vie**

- Limitatore di portata con freno al 50%
- Ingresso acqua calda e acqua fredda  $\varnothing$  1/2"
- Uscite  $\varnothing$  1/2"
- Deviatore con ritorno automatico
- Parte esterna e parte incasso

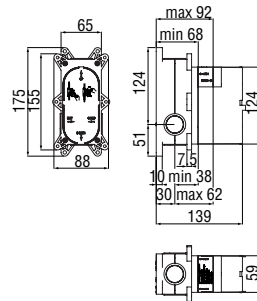
Cromo lucido SA99100CR **MOD** 170,00 €CARTRIDGE  
WARRANTYRCR350  
39,00 €NR00212/13CR  
57,00 €**Scatola opzionale**

- Per montaggio su cartongesso

- WE81100/SC 67,00 €



RUBINETTERIA ENNE DI NOBILI

# SKY

Centro Stile Nobili

La serenità del cielo azzurro, la forza dei colori della natura. La mutevolezza di una nuvola passeggera, il profumo di un ricordo. Riflessi in uno specchio, sentirsi parte del mondo. La duplice personalità stilistica del lavabo monocomando riflette compiutamente l'avanzato know-how del nostro brand, leader per innovazione ed efficienza tecnologica.

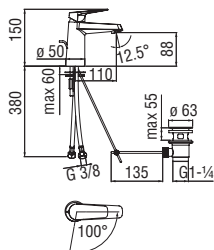

Cromo lucido

**Monocomando a risparmio idrico ed energetico**

- Limitatore di energia con apertura in acqua fredda
- Aeratore anticalcare M 24 x 1, portata 5 l/min
- Scarico 1 1/4" con sistema brevettato SNAP
- Flessibili inox ø 3/8"

Cromo lucido SYH97118/1CR 125,00 €

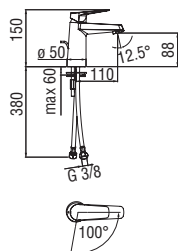
CARTRIDGE  
WARRANTYRCR350/ECO  
48,00 €RAEK219/23CR  
61,00 € - 10 pz.**Monocomando a risparmio idrico ed energetico**

- Limitatore di energia con apertura in acqua fredda
- Aeratore anticalcare M 24 x 1, portata 5 l/min
- Senza scarico
- Flessibili inox ø 3/8"

Cromo lucido SYH97118/2CR 122,00 €

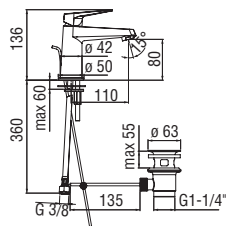
CARTRIDGE  
WARRANTYRCR350/ECO  
48,00 €RAEK219/23CR  
61,00 € - 10 pz.**Monocomando**

- Limitatore di portata con freno al 50%
- Aeratore anticalcare M 24 x 1
- Scarico 1 1/4" con sistema brevettato SNAP
- Flessibili inox ø 3/8"

Cromo lucido SY97116/1CR 98,00 €

CARTRIDGE  
WARRANTYRCR280/D  
39,00 €RAEK220/32CR  
45,00 € - 10 pz.

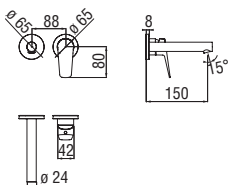
**Parte esterna monocomando a parete**

- Limitatore di portata con freno al 50%
- Aeratore anticalcare M 18 x 1
- Lunghezza bocca 150 mm
- Senza scarico

Cromo lucido

SY97199CR

172,00 €

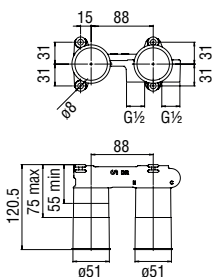
RAEK220/27CR  
43,00 € - 10 pz.NR00212/10CR  
43,00 €

-

WE00198

**MOD**

125,00 €

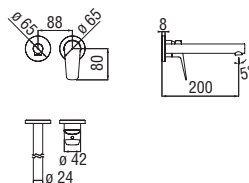
20 YEARS  
CARTRIDGE  
WARRANTYRCR350  
39,00 €**Parte esterna monocomando a parete bocca lunga**

- Limitatore di portata con freno al 50%
- Aeratore anticalcare M 18 x 1
- Lunghezza bocca 200 mm
- Senza scarico

Cromo lucido

SY97199/1CR

193,00 €

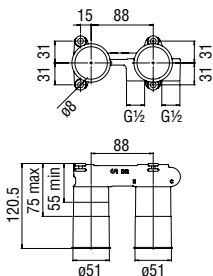
RAEK220/27CR  
43,00 € - 10 pz.NR00212/10CR  
43,00 €

-

WE00198

**MOD**

125,00 €

20 YEARS  
CARTRIDGE  
WARRANTYRCR350  
39,00 €

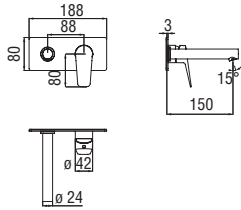

**Parte esterna monocomando a parete**

- Limitatore di portata con freno al 50%
- Aeratore anticalcare M 18 x 1
- Lunghezza bocca 150 mm
- Senza scarico

Cromo lucido SY97198CR 186,00 €

RAEK220/27CR  
43,00 € - 10 pz.

NR00212/10CR  
43,00 €

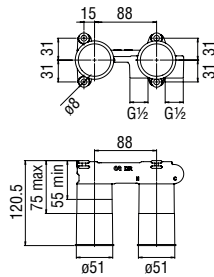

**Allbox, parte incasso necessaria**

- Ingresso acqua calda e acqua fredda ø 1/2"
- Uscita ø 1/2"

- WE00198 **MOD** 125,00 €

20 YEARS WARRANTY

RCR350  
39,00 €

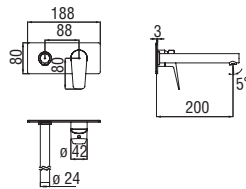
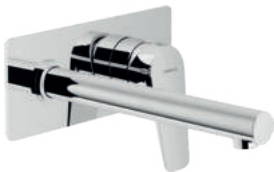

**Parte esterna monocomando a parete bocca lunga**

- Limitatore di portata con freno al 50%
- Aeratore anticalcare M 18 x 1
- Lunghezza bocca 200 mm
- Senza scarico

Cromo lucido SY97198/1CR 208,00 €

RAEK220/27CR  
43,00 € - 10 pz.

NR00212/10CR  
43,00 €

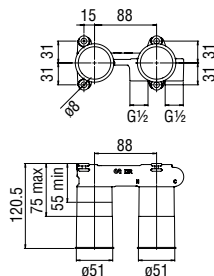

**Allbox, parte incasso necessaria**

- Ingresso acqua calda e acqua fredda ø 1/2"
- Uscita ø 1/2"

- WE00198 **MOD** 125,00 €

20 YEARS WARRANTY

RCR350  
39,00 €

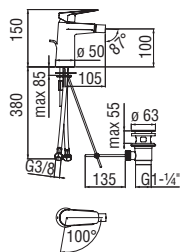

**Monocomando a risparmio idrico ed energetico**

- Limitatore di energia con apertura in acqua fredda
- Aeratore anticalcare M 16,5 x 1, portata 5 l/min
- Getto orientabile
- Scarico 1 1/4" con sistema brevettato SNAP
- Flessibili inox ø 3/8"

Cromo lucido SY97119/1CR 125,00 €



CARTRIDGE WARRANTY



RCR350/ECO 48,00 €



RAE219/28CR 22,00 € - 1 pz.

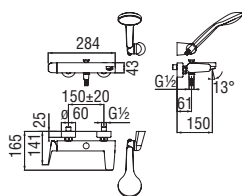

**Monocomando esterno con set doccia**

- Limitatore di portata con freno al 50%
- Aeratore anticalcare M 28 x 1
- Deviatore con ritorno automatico
- Supporto doccetta orientabile
- Doccetta monogetto e flessibile 150 cm

Cromo lucido SY97110CR 232,00 €



CARTRIDGE WARRANTY



RCR350 39,00 €



RAEK219/4CR 43,00 € - 5 pz.

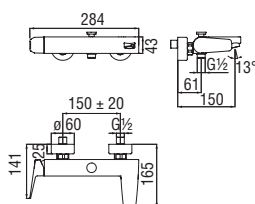

**Monocomando esterno**

- Limitatore di portata con freno al 50%
- Aeratore anticalcare M 28 x 1
- Deviatore con ritorno automatico
- Uscita ø 1/2"

Cromo lucido SY97110/1CR 181,00 €



CARTRIDGE WARRANTY



RCR350 39,00 €



RAEK219/4CR 43,00 € - 5 pz.

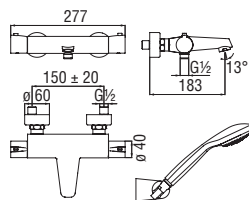

**Termostatico esterno con set doccia**

- Blocco di sicurezza 38° C
- Valvole antiritorno
- Aeratore anticalcare M 28 x 1
- Supporto doccetta orientabile
- Doccetta monogetto e flessibile 150 cm
- Filtri di ricambio cartuccia inclusi nella confezione

Cromo lucido SY97010CR 422,00 €



RCR201/5 58,00 €



RCR201/70 39,00 €



RAEK219/4CR 43,00 € - 5 pz.

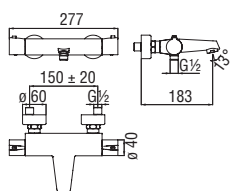

**Termostatico esterno**

- Blocco di sicurezza 38° C
- Valvole antiritorno
- Aeratore anticalcare M 28 x 1
- Uscita ø 1/2"
- Filtri di ricambio cartuccia inclusi nella confezione

Cromo lucido SY97010/1CR 362,00 €

 RCR201/5  
58,00 €

 RCR201/70  
39,00 €

 RAEK219/4CR  
43,00 € - 5 pz.

DOCCIA

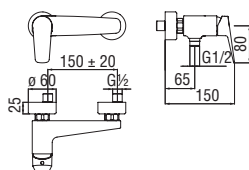

**Monocomando esterno**

- Limitatore di portata con freno al 50%
- Uscita ø 1/2"

Cromo lucido SY97130CR 167,00 €

 20 YEARS WARRANTY

 RCR350/D  
39,00 €

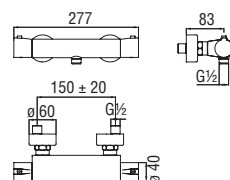

**Termostatico esterno**

- Blocco di sicurezza 38° C
- Valvole antiritorno
- Sistema anticalcare
- Uscita ø 1/2"
- Filtri di ricambio cartuccia inclusi nella confezione

Cromo lucido SY97030CR 217,00 €

 RCR201/6  
58,00 €

 RVT200/26  
18,00 €

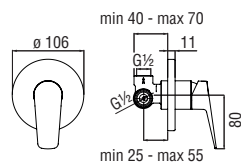

**Monocomando incasso**

- Limitatore di portata con freno al 50%
- Ingresso acqua calda e acqua fredda ø 1/2"
- Uscita ø 1/2"
- Parte esterna e parte incasso

Cromo lucido SY97108CR **MOD** 70,00 €

 20 YEARS WARRANTY

 RCR350  
39,00 €

 NR00212/10CR  
43,00 €

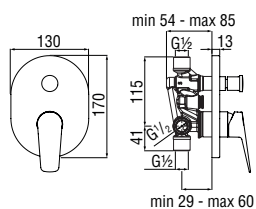
**Monocomando incasso**

- Limitatore di portata con freno al 50%
- Ingresso acqua calda e acqua fredda  $\varnothing$  1/2"
- Uscite  $\varnothing$  1/2"
- Deviatore con ritorno automatico
- Parte esterna e parte incasso

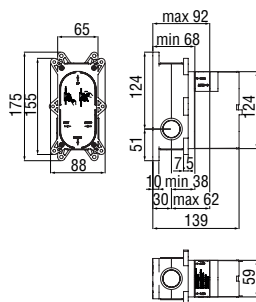
Cromo lucido SY97100CR **MOD** 158,00 €CARTRIDGE  
WARRANTYRCR350  
39,00 €NR00212/13CR  
57,00 €**Scatola opzionale**

- Per montaggio su cartongesso

- WE81100/SC 67,00 €





RUBINETTERIA ENNE DI NOBILI

# NEW ROAD

Centro Stile Nobili

Un ambiente bagno dall'anima totalmente sostenibile. Uno spazio intimo e riservato, dove pace e tranquillità vivono in armonia con il più sincero benessere interiore. L'incredibile risparmio idrico ed energetico della cartuccia a immersione totale Nobili Widd® è simbolo inequivocabile della nostra più grande passione: l'innovazione tecnologica.

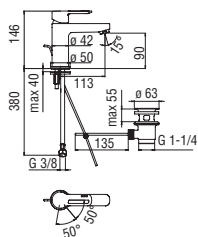

Cromo lucido

**Monocomando a risparmio idrico ed energetico**

- Limitatore di energia con apertura in acqua fredda
- Aeratore anticalcare M 24 x 1, portata 5 l/min
- Scarico 1 1/4" con sistema brevettato SNAP
- Flessibili inox  $\varnothing$  3/8"

Cromo lucido RDH00118/1CR 132,00 €

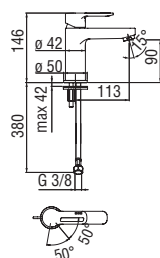
CARTRIDGE  
WARRANTYRCR350/ECO  
48,00 €RAEK219/23CR  
61,00 € - 10 pz.**Monocomando a risparmio idrico ed energetico**

- Limitatore di energia con apertura in acqua fredda
- Aeratore anticalcare M 24 x 1, portata 5 l/min
- Senza scarico
- Flessibili inox  $\varnothing$  3/8"

Cromo lucido RDH00118/2CR 129,00 €

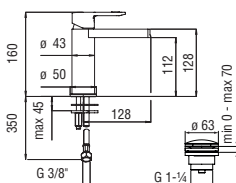
CARTRIDGE  
WARRANTYRCR350/ECO  
48,00 €RAEK219/23CR  
61,00 € - 10 pz.**Monocomando con bocca a cascata**

- Limitatore di portata con freno al 50%
- Scarico 1 1/4" push
- Flessibili inox  $\varnothing$  3/8"

Cromo lucido RDC0118/2CR 250,00 €

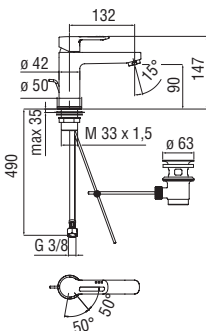
CARTRIDGE  
WARRANTYRCR284/D  
39,00 €**Monocomando bocca lunga a risparmio idrico ed energetico**

- Limitatore di energia con apertura in acqua fredda
- Aeratore anticalcare M 24 x 1, portata 5 l/min
- Scarico 1 1/4" con sistema brevettato SNAP
- Flessibili inox  $\varnothing$  3/8"

Cromo lucido RDH00118/2OCR 180,00 €

CARTRIDGE  
WARRANTYRCR350/ECO  
48,00 €RAEK219/23CR  
61,00 € - 10 pz.

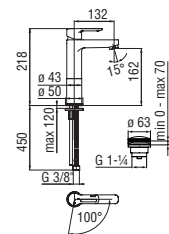
**Monocomando a bacinella a risparmio idrico ed energetico**

- Limitatore di energia con apertura in acqua fredda
- Aeratore anticalcare M 24 x 1, portata 5 l/min
- Scarico 1 1/4" push
- Flessibili inox ø 3/8"

Cromo lucido RDH00158/2CR 306,00 €

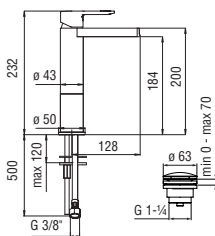
CARTRIDGE  
WARRANTYRCR350/ECO  
48,00 €RAEK219/23CR  
61,00 € - 10 pz.**Monocomando a bacinella con bocca a cascata**

- Limitatore di portata con freno al 50%
- Scarico 1 1/4" push
- Flessibili inox ø 3/8"

Cromo lucido RDC0158/2CR 440,00 €

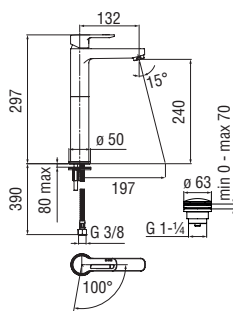
CARTRIDGE  
WARRANTYRCR284/D  
39,00 €**Monocomando a bacinella a risparmio idrico ed energetico**

- Limitatore di energia con apertura in acqua fredda
- Aeratore anticalcare M 24 x 1, portata 5 l/min
- Scarico 1 1/4" push
- Flessibili inox ø 3/8"

Cromo lucido RDH00128/2CR 330,00 €

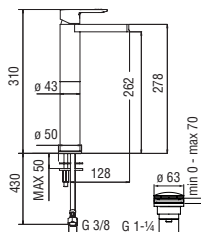
CARTRIDGE  
WARRANTYRCR350/ECO  
48,00 €RAEK219/23CR  
61,00 € - 10 pz.**Monocomando a bacinella con bocca a cascata**

- Limitatore di portata con freno al 50%
- Scarico 1 1/4" push
- Flessibili inox ø 3/8"

Cromo lucido RDC0128/2CR 465,00 €

CARTRIDGE  
WARRANTYRCR284/D  
39,00 €

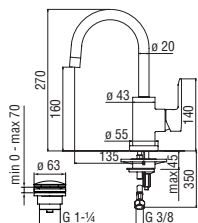
**Monocomando**

- Limitatore di portata con freno al 50%
- Aeratore anticalcare M 16 x 1
- Corpo girevole 360°
- Scarico 1 1/4" push
- Flessibili inox ø 3/8"

Cromo lucido

RD00338/2CR

333,00 €

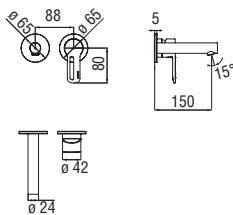
CARTRIDGE  
WARRANTYRCR360/D  
39,00 €RAEK222/10CR  
58,00 € - 10 pz.**Parte esterna monocomando a parete**

- Limitatore di portata con freno al 50%
- Aeratore anticalcare M 18 x 1
- Lunghezza bocca 150 mm
- Senza scarico

Cromo lucido

RD00199CR

226,00 €

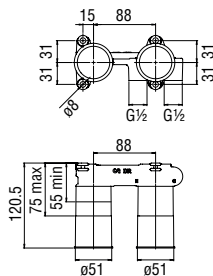
RAEK220/27CR  
43,00 € - 10 pz.NR00212/10CR  
43,00 €**Allbox, parte incasso necessaria**

- Ingresso acqua calda e acqua fredda ø 1/2"
- Uscita ø 1/2"

-

WE00198

**MOD**

125,00 €

CARTRIDGE  
WARRANTYRCR350  
39,00 €

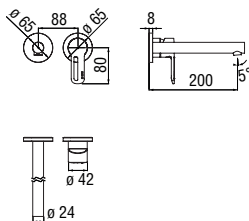
**Parte esterna monocomando a parete bocca lunga**

- Limitatore di portata con freno al 50%
- Aeratore anticalcare M 18 x 1
- Lunghezza bocca 200 mm
- Senza scarico

Cromo lucido RD00199/1CR 254,00 €

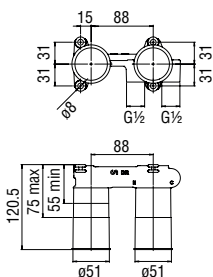
RAEK220/27CR  
43,00 € - 10 pz.NR00212/10CR  
43,00 €**Allbox, parte incasso necessaria**

- Ingresso acqua calda e acqua fredda  $\varnothing 1/2"$
- Uscita  $\varnothing 1/2"$

- WE00198 MOD 125,00 €

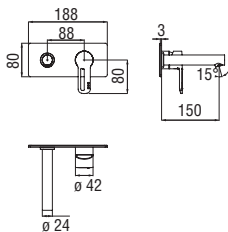
20 YEARS  
CARTRIDGE  
WARRANTYRCR350  
39,00 €**Parte esterna monocomando a parete**

- Limitatore di portata con freno al 50%
- Aeratore anticalcare M 18 x 1
- Lunghezza bocca 150 mm
- Senza scarico

Cromo lucido RD00198CR 244,00 €

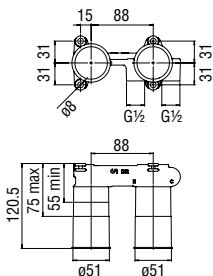
RAEK220/27CR  
43,00 € - 10 pz.NR00212/10CR  
43,00 €**Allbox, parte incasso necessaria**

- Ingresso acqua calda e acqua fredda  $\varnothing 1/2"$
- Uscita  $\varnothing 1/2"$

- WE00198 MOD 125,00 €

20 YEARS  
CARTRIDGE  
WARRANTYRCR350  
39,00 €

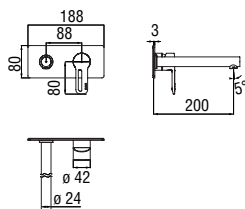
**Parte esterna monocomando a parete bocca lunga**

- Limitatore di portata con freno al 50%
- Aeratore anticalcare M 18 x 1
- Lunghezza bocca 200 mm
- Senza scarico

Cromo lucido RD00198/1CR 270,00 €

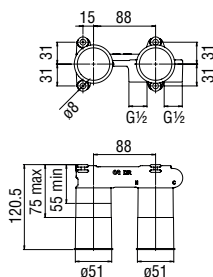
RAEK220/27CR  
43,00 € - 10 pz.NR00212/10CR  
43,00 €**Allbox, parte incasso necessaria**

- Ingresso acqua calda e acqua fredda  $\varnothing$  1/2"
- Uscita  $\varnothing$  1/2"

- WE00198 MOD 125,00 €

CARTRIDGE  
WARRANTYRCR350  
39,00 €

## BIDET

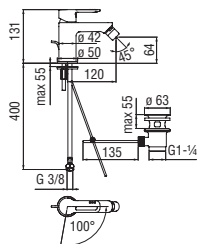
**Monocomando a risparmio idrico ed energetico**

- Limitatore di energia con apertura in acqua fredda
- Aeratore anticalcare M 22 x 1, portata 5 l/min
- Getto orientabile
- Scarico 1 1/4" con sistema brevettato SNAP
- Flessibili inox  $\varnothing$  3/8"

Cromo lucido RDH00119/1CR 132,00 €

CARTRIDGE  
WARRANTYRCR350/ECO  
48,00 €RAEK219/22CR  
22,00 € - 1 pz.

## VASCA

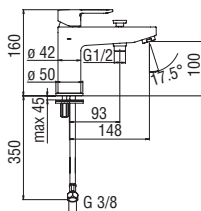
**Monocomando**

- Limitatore di portata con freno al 50%
- Aeratore anticalcare M 24 x 1
- Deviatore con ritorno automatico
- Valvole antiritorno
- Uscita  $\varnothing$  1/2"

Cromo lucido RD00118/10CR 190,00 €

CARTRIDGE  
WARRANTYRCR350/D  
39,00 €RAEK220/14CR  
45,00 € - 10 pz.

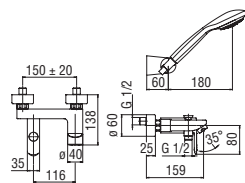

**Monocomando esterno con set doccia**

- Limitatore di portata con freno al 50%
- Aeratore anticalcare M 28 x 1
- Deviatore con ritorno automatico
- Supporto doccetta orientabile
- Doccetta monogetto e flessibile 150 cm

Cromo lucido RD00110CR 193,00 €



CARTRIDGE  
WARRANTY



RCR350/D  
39,00 €



RAEK219/4CR  
43,00 € - 5 pz.

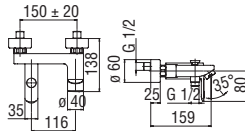

**Monocomando esterno**

- Limitatore di portata con freno al 50%
- Aeratore anticalcare M 28 x 1
- Deviatore con ritorno automatico
- Uscita ø 1/2"

Cromo lucido RD00110/ICR 145,00 €



CARTRIDGE  
WARRANTY



RCR350/D  
39,00 €



RAEK219/4CR  
43,00 € - 5 pz.

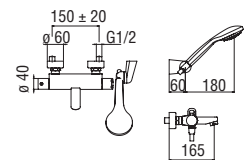

**Termostatico esterno con set doccia**

- Blocco di sicurezza 38° C
- Valvole antiritorno
- Aeratore anticalcare M 28 x 1
- Supporto doccetta orientabile
- Doccetta monogetto e flessibile 150 cm
- Filtri di ricambio cartuccia inclusi nella confezione

Cromo lucido RD00410CR 399,00 €



RCR201/5  
58,00 €



RCR201/70  
39,00 €



RAEK219/4CR  
43,00 € - 5 pz.

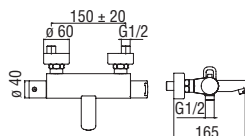

**Termostatico esterno**

- Blocco di sicurezza 38° C
- Valvole antiritorno
- Aeratore anticalcare M 28 x 1
- Uscita ø 1/2"
- Filtri di ricambio cartuccia inclusi nella confezione

Cromo lucido RD00410/ICR 343,00 €



RCR201/5  
58,00 €



RCR201/70  
39,00 €

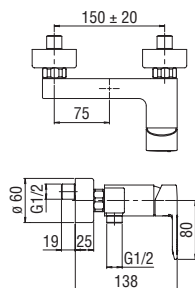

RAEK219/4CR  
43,00 € - 5 pz.

**Monocomando esterno**

- Limitatore di portata con freno al 50%
- Uscita  $\varnothing$  1/2"

Cromo lucido RD00130CR 140,00 €

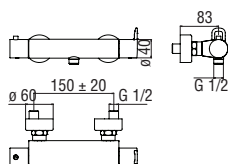
CARTRIDGE  
WARRANTYRCR350/D  
39,00 €**Termostatico esterno**

- Blocco di sicurezza 38° C
- Valvole antiritorno
- Uscita  $\varnothing$  1/2"
- Filtri di ricambio cartuccia inclusi nella confezione

Cromo lucido RD00430CR 239,00 €

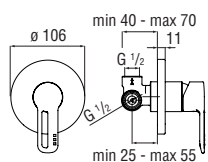
RCR201/6  
58,00 €RVT200/26  
18,00 €**Monocomando incasso a 1 via**

- Limitatore di portata con freno al 50%
- Ingresso acqua calda e acqua fredda  $\varnothing$  1/2"
- Uscita  $\varnothing$  1/2"
- Parte esterna e parte incasso

Cromo lucido RD00108CR MOD 72,00 €

CARTRIDGE  
WARRANTYRCR350  
39,00 €NR00212/10CR  
43,00 €



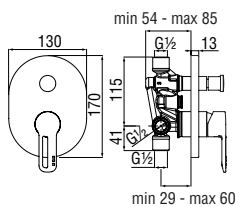

### Monocomando incasso a 2 vie

- Limitatore di portata con freno al 50%
- Ingresso acqua calda e acqua fredda  $\varnothing$  1/2"
- Uscite  $\varnothing$  1/2"
- Deviatore con ritorno automatico
- Parte esterna e parte incasso

Cromo lucido RD00100CR **MOD** 161,00 €



CARTRIDGE  
WARRANTY



RCR350  
39,00 €



NR00212/13CR  
57,00 €

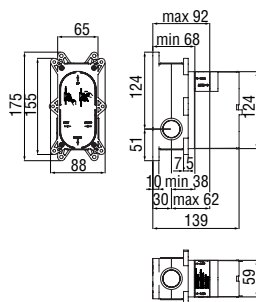

### Scatola opzionale

- Per montaggio su cartongesso

- WE81100/SC 67,00 €



ACCESSORI

# ZEN

Centro Stile Nobili

Pensata in abbinamento ai tratti minimalisti delle collezioni di rubinetteria Sole, Velis, Dress, Likid, Live, Acquerelli, Uno, Yoyo, Up e Lira, l'ampia gamma di accessori Zen evoca lo stile essenziale dei miscelatori, fondendosi armoniosamente con l'architettura della sala da bagno e dando vita ad atmosfere moderne ed eleganti.



Cromo lucido



Inox spazzolato



Grafite spazzolato PVD



Mora opaco



Neve opaco



Miele spazzolato PVD



Caffè spazzolato



Tramonto lucido PVD



Argilla spazzolato PVD

**Porta sapone**

· Da appoggio

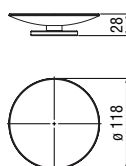

Cromo lucido	ACPL01CR	110,00 €
Inox spazzolato	ACPL01IX	166,00 €
Grafite spazzolato PVD	ACPL01GUP	177,00 €
Mora opaco	ACPL01BM	166,00 €
Neve opaco	ACPL01WM	166,00 €
Miele spazzolato PVD	ACPL01CGP	<b>NEW</b> 177,00 €
Caffè spazzolato	ACPL01SB	<b>NEW</b> 177,00 €
Tramonto lucido PVD	ACPL01RCP	177,00 €
Argilla spazzolato PVD	ACPL01RTP	177,00 €

**Porta sapone**

· A parete

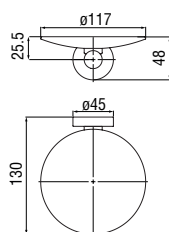

Cromo lucido	ACPL02CR	105,00 €
Inox spazzolato	ACPL02IX	158,00 €
Grafite spazzolato PVD	ACPL02GUP	167,00 €
Mora opaco	ACPL02BM	158,00 €
Neve opaco	ACPL02WM	158,00 €
Miele spazzolato PVD	ACPL02CGP	<b>NEW</b> 167,00 €
Caffè spazzolato	ACPL02SB	<b>NEW</b> 167,00 €
Tramonto lucido PVD	ACPL02RCP	167,00 €
Argilla spazzolato PVD	ACPL02RTP	167,00 €

**Porta bicchiere**

· Da appoggio

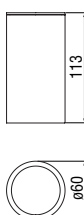

Cromo lucido	ACPL11CR	125,00 €
Inox spazzolato	ACPL11IX	188,00 €
Grafite spazzolato PVD	ACPL11GUP	201,00 €
Mora opaco	ACPL11BM	188,00 €
Neve opaco	ACPL11WM	188,00 €
Miele spazzolato PVD	ACPL11CGP	<b>NEW</b> 201,00 €
Caffè spazzolato	ACPL11SB	<b>NEW</b> 201,00 €
Tramonto lucido PVD	ACPL11RCP	201,00 €
Argilla spazzolato PVD	ACPL11RTP	201,00 €

**Porta bicchiere**

· A parete

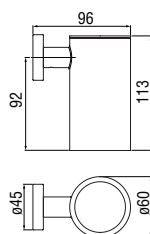

Cromo lucido	ACPL12CR	125,00 €
Inox spazzolato	ACPL12IX	188,00 €
Grafite spazzolato PVD	ACPL12GUP	201,00 €
Mora opaco	ACPL12BM	188,00 €
Neve opaco	ACPL12WM	188,00 €
Miele spazzolato PVD	ACPL12CGP	<b>NEW</b> 201,00 €
Caffè spazzolato	ACPL12SB	<b>NEW</b> 201,00 €
Tramonto lucido PVD	ACPL12RCP	201,00 €
Argilla spazzolato PVD	ACPL12RTP	201,00 €

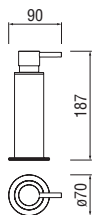

### Spandisapone

· Da appoggio

Cromo lucido	ACPL61CR	105,00 €
Inox spazzolato	ACPL61IX	158,00 €
Grafite spazzolato PVD	ACPL61GUP	167,00 €
Mora opaco	ACPL61BM	158,00 €
Neve opaco	ACPL61WM	158,00 €
Miele spazzolato PVD	ACPL61CGP	<b>NEW</b> 167,00 €
Caffè spazzolato	ACPL61SB	<b>NEW</b> 167,00 €
Tramonto lucido PVD	ACPL61RCP	167,00 €
Argilla spazzolato PVD	ACPL61RTP	167,00 €

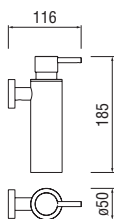

### Spandisapone

· A parete

Cromo lucido	ACPL62CR	156,00 €
Inox spazzolato	ACPL62IX	234,00 €
Grafite spazzolato PVD	ACPL62GUP	249,00 €
Mora opaco	ACPL62BM	234,00 €
Neve opaco	ACPL62WM	234,00 €
Miele spazzolato PVD	ACPL62CGP	<b>NEW</b> 249,00 €
Caffè spazzolato	ACPL62SB	<b>NEW</b> 249,00 €
Tramonto lucido PVD	ACPL62RCP	249,00 €
Argilla spazzolato PVD	ACPL62RTP	249,00 €

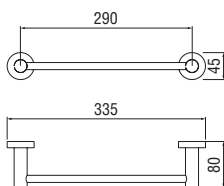

### Porta salvietta

· A parete

Cromo lucido	ACPL20/335CR	105,00 €
Inox spazzolato	ACPL20/335IX	158,00 €
Grafite spazzolato PVD	ACPL20/335GUP	167,00 €
Mora opaco	ACPL20/335BM	158,00 €
Neve opaco	ACPL20/335WM	142,00 €
Miele spazzolato PVD	ACPL20/335CGP	<b>NEW</b> 167,00 €
Caffè spazzolato	ACPL20/335SB	<b>NEW</b> 167,00 €
Tramonto lucido PVD	ACPL20/335RCP	167,00 €
Argilla spazzolato PVD	ACPL20/335RTP	167,00 €

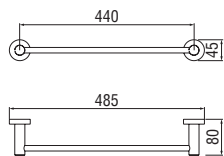

### Porta salvietta

· A parete

Cromo lucido	ACPL20/485CR	111,00 €
Inox spazzolato	ACPL20/485IX	168,00 €
Grafite spazzolato PVD	ACPL20/485GUP	180,00 €
Mora opaco	ACPL20/485BM	168,00 €
Neve opaco	ACPL20/485WM	168,00 €
Miele spazzolato PVD	ACPL20/485CGP	<b>NEW</b> 180,00 €
Caffè spazzolato	ACPL20/485SB	<b>NEW</b> 180,00 €
Tramonto lucido PVD	ACPL20/485RCP	180,00 €
Argilla spazzolato PVD	ACPL20/485RTP	180,00 €

**Porta salvietta**

· A parete

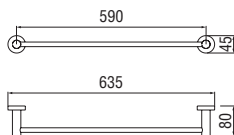

Cromo lucido	ACPL20/635CR	125,00 €
Inox spazzolato	ACPL20/635IX	188,00 €
Grafite spazzolato PVD	ACPL20/635GUP	201,00 €
Mora opaco	ACPL20/635BM	188,00 €
Neve opaco	ACPL20/635WM	188,00 €
Miele spazzolato PVD	ACPL20/635CGP	<b>NEW</b> 201,00 €
Caffè spazzolato	ACPL20/635SB	<b>NEW</b> 201,00 €
Tramonto lucido PVD	ACPL20/635RCP	201,00 €
Argilla spazzolato PVD	ACPL20/635RTP	201,00 €

**Porta salvietta**

· A parete

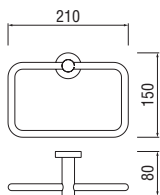

Cromo lucido	ACPL25CR	130,00 €
Inox spazzolato	ACPL25IX	195,00 €
Grafite spazzolato PVD	ACPL25GUP	208,00 €
Mora opaco	ACPL25BM	195,00 €
Neve opaco	ACPL25WM	195,00 €
Miele spazzolato PVD	ACPL25CGP	<b>NEW</b> 208,00 €
Caffè spazzolato	ACPL25SB	<b>NEW</b> 208,00 €
Tramonto lucido PVD	ACPL25RCP	208,00 €
Argilla spazzolato PVD	ACPL25RTP	208,00 €

**Porta salvietta estensibile**

· A parete

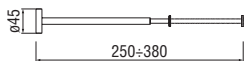

Cromo lucido	ACPL21CR	95,00 €
Grafite spazzolato PVD	ACPL21GUP	151,00 €
Mora opaco	ACPL21BM	142,00 €
Neve opaco	ACPL21WM	142,00 €
Miele spazzolato PVD	ACPL21CGP	<b>NEW</b> 151,00 €
Caffè spazzolato	ACPL21SB	<b>NEW</b> 151,00 €
Tramonto lucido PVD	ACPL21RCP	151,00 €
Argilla spazzolato PVD	ACPL21RTP	151,00 €

**Porta salvietta**

· A parete

· A snodo

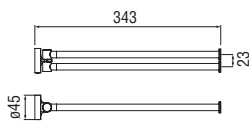

Cromo lucido	ACPL22/2XCR	125,00 €
Inox spazzolato	ACPL22/2XIX	188,00 €
Grafite spazzolato PVD	ACPL22/2XGUP	201,00 €
Mora opaco	ACPL22/2XBM	188,00 €
Neve opaco	ACPL22/2XWM	188,00 €
Miele spazzolato PVD	ACPL22/2XCGP	<b>NEW</b> 201,00 €
Caffè spazzolato	ACPL22/2XSB	<b>NEW</b> 201,00 €
Tramonto lucido PVD	ACPL22/2XRCP	201,00 €
Argilla spazzolato PVD	ACPL22/2XRTP	201,00 €

**Porta salvietta estensibile**

- A parete
- A snodo

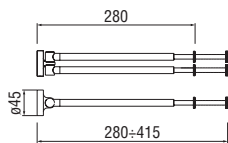

Cromo lucido	ACPL23/2XCR	181,00 €
Grafite spazzolato PVD	ACPL23/2XGUP	288,00 €
Mora opaco	ACPL23/2XBM	271,00 €
Neve opaco	ACPL23/2XWM	271,00 €
Miele spazzolato PVD	ACPL23/2XCGP	<b>NEW</b> 288,00 €
Caffè spazzolato	ACPL23/2XSB	<b>NEW</b> 288,00 €
Tramonto lucido PVD	ACPL23/2XRCP	288,00 €
Argilla spazzolato PVD	ACPL23/2XRTP	288,00 €

**Piantana**

- A pavimento

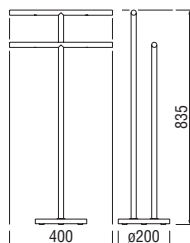

Cromo lucido	ACPL80/2XCR	764,00 €
Grafite spazzolato PVD	ACPL80/2XGUP	1.224,00 €
Mora opaco	ACPL80/2XBM	1.148,00 €
Neve opaco	ACPL80/2XWM	1.148,00 €
Miele spazzolato PVD	ACPL80/2XCGP	<b>NEW</b> 1.224,00 €
Caffè spazzolato	ACPL80/2XSB	<b>NEW</b> 1.224,00 €
Tramonto lucido PVD	ACPL80/2XRCP	1.224,00 €
Argilla spazzolato PVD	ACPL80/2XRTP	1.224,00 €

**Rack porta salviette**

- A parete

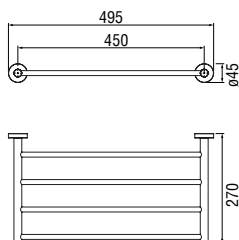

Cromo lucido	ACPL24CR	307,00 €
Inox spazzolato	ACPL24IX	461,00 €
Grafite spazzolato PVD	ACPL24GUP	490,00 €
Mora opaco	ACPL24BM	461,00 €
Neve opaco	ACPL24WM	461,00 €
Miele spazzolato PVD	ACPL24CGP	<b>NEW</b> 490,00 €
Caffè spazzolato	ACPL24SB	<b>NEW</b> 490,00 €
Tramonto lucido PVD	ACPL24RCP	490,00 €
Argilla spazzolato PVD	ACPL24RTP	490,00 €

**Appendino**

- A parete

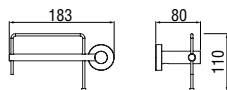

Cromo lucido	ACPL50CR	51,00 €
Inox spazzolato	ACPL50IX	78,00 €
Grafite spazzolato PVD	ACPL50GUP	83,00 €
Mora opaco	ACPL50BM	78,00 €
Neve opaco	ACPL50WM	78,00 €
Miele spazzolato PVD	ACPL50CGP	<b>NEW</b> 83,00 €
Caffè spazzolato	ACPL50SB	<b>NEW</b> 83,00 €
Tramonto lucido PVD	ACPL50RCP	83,00 €
Argilla spazzolato PVD	ACPL50RTP	83,00 €

**Porta rololo**

· A parete

Cromo lucido	ACPL30/SXCR	82,00 €
Inox spazzolato	ACPL30/SXIX	122,00 €
Grafite spazzolato PVD	ACPL30/SXGUP	130,00 €
Mora opaco	ACPL30/SXBM	122,00 €
Neve opaco	ACPL30/SXWM	122,00 €
Miele spazzolato PVD	ACPL30/SXCGP	<b>NEW</b> 130,00 €
Caffè spazzolato	ACPL30/SXSB	<b>NEW</b> 130,00 €
Tramonto lucido PVD	ACPL30/SXRCP	130,00 €
Argilla spazzolato PVD	ACPL30/SXRTP	130,00 €

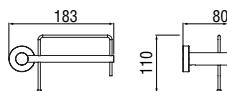
**Porta rololo**

· A parete

Cromo lucido	ACPL30/DXCR	82,00 €
Inox spazzolato	ACPL30/DXIX	122,00 €
Grafite spazzolato PVD	ACPL30/DXGUP	130,00 €
Mora opaco	ACPL30/DXBM	122,00 €
Neve opaco	ACPL30/DXWM	122,00 €
Miele spazzolato PVD	ACPL30/DXCGP	<b>NEW</b> 130,00 €
Caffè spazzolato	ACPL30/DXSB	<b>NEW</b> 130,00 €
Tramonto lucido PVD	ACPL30/DXRCP	130,00 €
Argilla spazzolato PVD	ACPL30/DXRTP	130,00 €

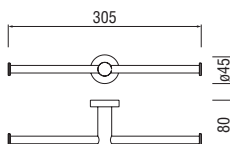
**Porta rololo**

· A parete

Cromo lucido	ACPL30/2XCR	93,00 €
Inox spazzolato	ACPL30/2XIX	140,00 €
Grafite spazzolato PVD	ACPL30/2XGUP	149,00 €
Mora opaco	ACPL30/2XBM	140,00 €
Neve opaco	ACPL30/2XWM	140,00 €
Miele spazzolato PVD	ACPL30/2XCGP	<b>NEW</b> 149,00 €
Caffè spazzolato	ACPL30/2XSB	<b>NEW</b> 149,00 €
Tramonto lucido PVD	ACPL30/2XRCP	149,00 €
Argilla spazzolato PVD	ACPL30/2XRTP	149,00 €

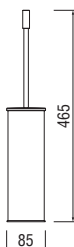
**Porta scopino**

· A pavimento

Cromo lucido	ACPL41/465CR	130,00 €
Inox spazzolato	ACPL41/465IX	195,00 €
Grafite spazzolato PVD	ACPL41/465GUP	208,00 €
Mora opaco	ACPL41/465BM	195,00 €
Neve opaco	ACPL41/465WM	195,00 €
Miele spazzolato PVD	ACPL41/465CGP	<b>NEW</b> 208,00 €
Caffè spazzolato	ACPL41/465SB	<b>NEW</b> 208,00 €
Tramonto lucido PVD	ACPL41/465RCP	208,00 €
Argilla spazzolato PVD	ACPL41/465RTP	208,00 €

ACPL42/01  
28,00 €



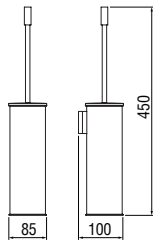

### Porta scopino

· A parete

Cromo lucido	ACPL42CR		152,00 €
Inox spazzolato	ACPL42IX		228,00 €
Grafite spazzolato PVD	ACPL42GUP		244,00 €
Mora opaco	ACPL42BM		228,00 €
Neve opaco	ACPL42WM		228,00 €
Miele spazzolato PVD	ACPL42CGP	NEW	244,00 €
Caffè spazzolato	ACPL42SB	NEW	244,00 €
Tramonto lucido PVD	ACPL42RCP		244,00 €
Argilla spazzolato PVD	ACPL42RTP		244,00 €



ACPL42/01  
28,00 €

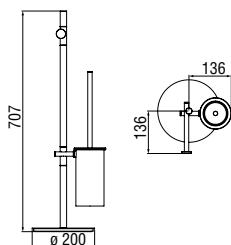

### Colonna zona wc

· A pavimento

Cromo lucido	ACPL92CR		345,00 €
Grafite spazzolato PVD	ACPL92GUP		552,00 €
Mora opaco	ACPL92BM		517,00 €
Neve opaco	ACPL92WM		517,00 €
Miele spazzolato PVD	ACPL92CGP	NEW	552,00 €
Caffè spazzolato	ACPL92SB	NEW	552,00 €
Tramonto lucido PVD	ACPL92RCP		552,00 €
Argilla spazzolato PVD	ACPL92RTP		552,00 €



ACPL92/04  
28,00 €



ACCESSORI

# TODAY

Piet Billekens

Così come la rubinetteria alla quale sono ispirati, anche gli accessori Today dedicati alle collezioni Loop e Acquaviva si distinguono per le forme morbide ed arrotondate degli spigoli: qualsiasi modello all'interno della vasta gamma di proposte è in grado di coordinarsi alla perfezione all'interno della sala da bagno.



Cromo lucido

**Porta sapone**

· Da appoggio

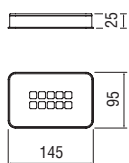

Cromo lucido      ACLP01CR      114,00 €

**Porta sapone**

· A parete

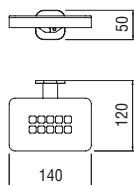

Cromo lucido      ACLP02CR      93,00 €

**Porta bicchiere**

· Da appoggio



Cromo lucido      ACLP11CR      120,00 €

**Porta bicchiere**

· A parete

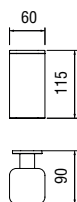

Cromo lucido      ACLP12CR      122,00 €

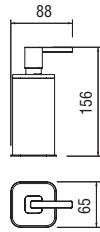

**Spandisapone**  
· Da appoggio

Cromo lucido      ACLP61CR      213,00 €

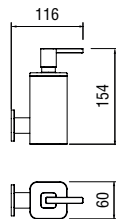

**Spandisapone**  
· A parete

Cromo lucido      ACLP62CR      213,00 €

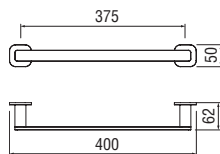

**Porta salvietta**  
· A parete

Cromo lucido      ACLP20/400CR      138,00 €

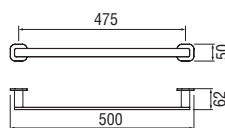

**Porta salvietta**  
· A parete

Cromo lucido      ACLP20/500CR      156,00 €

**Porta salvietta**

· A parete

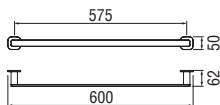

Cromo lucido      ACLP20/600CR      160,00 €

**Porta salvietta**

· A parete

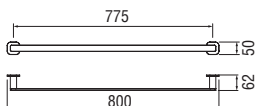

Cromo lucido      ACLP20/800CR      172,00 €

**Porta salvietta**

· A parete

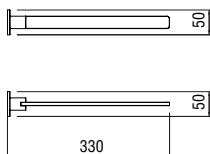

Cromo lucido      ACLP22CR      139,00 €

**Porta salvietta**

· A parete

· Doppio



Cromo lucido      ACLP22/2XCR      207,00 €

**Porta salvietta**

· A parete

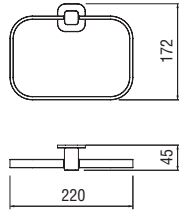

Cromo lucido      ACLP25CR      156,00 €

**Porta salviette**

· A parete

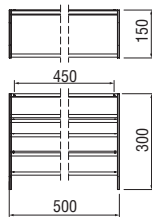

Cromo lucido      ACLP24CR      485,00 €

**Mensola porta oggetti**

· A parete

· In vetro

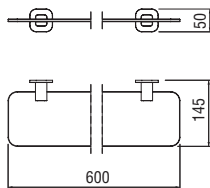

Cromo lucido      ACLP70/600CR      185,00 €

**Appendino**

· A parete



Cromo lucido      ACLP50CR      64,00 €

**Porta rotolo**

· A parete

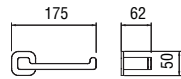

Cromo lucido

ACLP30CR

96,00 €

**Porta rotolo**

· A parete  
· Con coperchio



Cromo lucido

ACLP30/COCR

189,00 €

**Porta scopino**

· Da appoggio

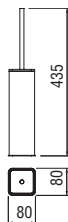

Cromo lucido

ACLP41CR

208,00 €

**Porta scopino**

· A parete

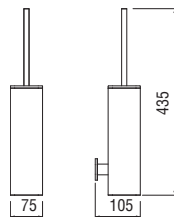

Cromo lucido

ACLP42CR

224,00 €



ACCESSORI

# NEOCLASSIC

Centro Stile Nobili

Gli accessori in ceramica Neoclassic per la sala da bagno accompagnano le forme sinuose delle collezioni di rubinetteria Sofi e Carlos Primero, accentuandone lo stile ed esaltandone i particolari. L'abbinamento dei diversi materiali crea un equilibrio formale in grado di dare vita ad un ambiente dove nulla è lasciato al caso.



Cromo lucido



Miele spazzolato PVD



Caffè spazzolato

**Porta sapone**

- Da appoggio
- In ceramica

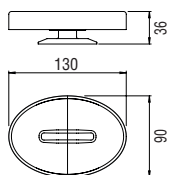

Cromo lucido	ACCP01CR		102,00 €
Miele spazzolato PVD	ACCP01CGP	NEW	163,00 €
Caffè spazzolato	ACCP01SB	NEW	163,00 €

**Porta sapone**

- A parete
- In ceramica

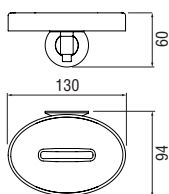

Cromo lucido	ACCP02CR		126,00 €
Miele spazzolato PVD	ACCP02CGP	NEW	202,00 €
Caffè spazzolato	ACCP02SB	NEW	202,00 €

**Porta bicchiere**

- Da appoggio
- In ceramica

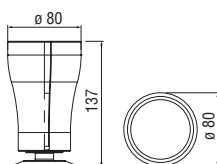

Cromo lucido	ACCP11CR		102,00 €
Miele spazzolato PVD	ACCP11CGP	NEW	163,00 €
Caffè spazzolato	ACCP11SB	NEW	163,00 €

**Porta bicchiere**

- A parete
- In ceramica

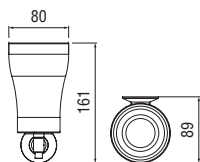

Cromo lucido	ACCP12CR		126,00 €
Miele spazzolato PVD	ACCP12CGP	NEW	202,00 €
Caffè spazzolato	ACCP12SB	NEW	202,00 €

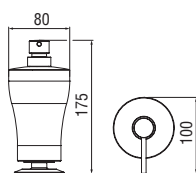
**Spandisapone**

- Da appoggio
- In ceramica

Cromo lucido	ACCP61CR		142,00 €
Miele spazzolato PVD	ACCP61CGP	NEW	227,00 €
Caffè spazzolato	ACCP61SB	NEW	227,00 €

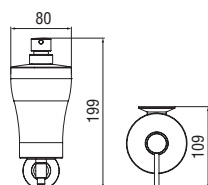
**Spandisapone**

- A parete
- In ceramica

Cromo lucido	ACCP62CR		167,00 €
Miele spazzolato PVD	ACCP62CGP	NEW	267,00 €
Caffè spazzolato	ACCP62SB	NEW	267,00 €

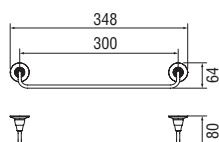
**Porta salvietta**

- A parete

Cromo lucido	ACCP20/300CR		140,00 €
Miele spazzolato PVD	ACCP20/300CGP	NEW	224,00 €
Caffè spazzolato	ACCP20/300SB	NEW	224,00 €

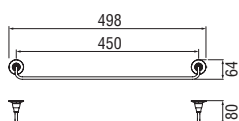
**Porta salvietta**

- A parete

Cromo lucido	ACCP20/450CR		146,00 €
Miele spazzolato PVD	ACCP20/450CGP	NEW	234,00 €
Caffè spazzolato	ACCP20/450SB	NEW	234,00 €

**Porta salvietta**

· A parete

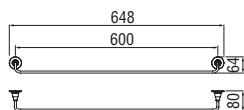

Cromo lucido	ACCP20/600CR		154,00 €
Miele spazzolato PVD	ACCP20/600CGP	<b>NEW</b>	246,00 €
Caffè spazzolato	ACCP20/600SB	<b>NEW</b>	246,00 €

**Porta salvietta**

· A parete

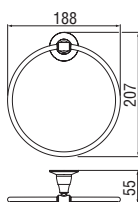

Cromo lucido	ACCP25CR		110,00 €
Miele spazzolato PVD	ACCP25CGP	<b>NEW</b>	176,00 €
Caffè spazzolato	ACCP25SB	<b>NEW</b>	176,00 €

**Porta salvietta**

· A parete

· Doppio

· A snodo

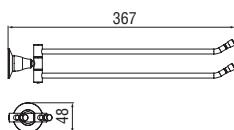

Cromo lucido	ACCP22CR		163,00 €
Miele spazzolato PVD	ACCP22CGP	<b>NEW</b>	261,00 €
Caffè spazzolato	ACCP22SB	<b>NEW</b>	261,00 €

**Mensola porta oggetti**

· A parete

· In ceramica

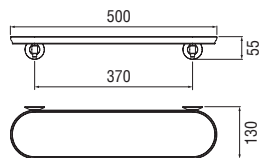

Cromo lucido	ACCP70CR		369,00 €
Miele spazzolato PVD	ACCP70CGP	<b>NEW</b>	590,00 €
Caffè spazzolato	ACCP70SB	<b>NEW</b>	590,00 €

**Appendino**

· A parete

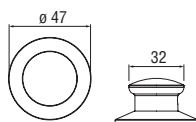

Cromo lucido	ACCP50CR		48,00 €
Miele spazzolato PVD	ACCP50CGP	NEW	77,00 €
Caffè spazzolato	ACCP50SB	NEW	77,00 €

**Porta rotolo**

· A parete

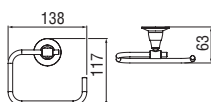

Cromo lucido	ACCP30CR		107,00 €
Miele spazzolato PVD	ACCP30CGP	NEW	171,00 €
Caffè spazzolato	ACCP30SB	NEW	171,00 €

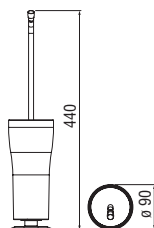
**Porta scopino**· A pavimento  
· In ceramica

Cromo lucido	ACCP41CR		163,00 €
Miele spazzolato PVD	ACCP41CGP	NEW	261,00 €
Caffè spazzolato	ACCP41SB	NEW	261,00 €

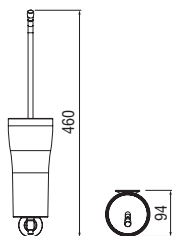
**Porta scopino**· A parete  
· In ceramica

Cromo lucido	ACCP42CR		186,00 €
Miele spazzolato PVD	ACCP42CGP	NEW	298,00 €
Caffè spazzolato	ACCP42SB	NEW	298,00 €



## CORPI INCASSO

Tutti i corpi incasso universali destinati alla realizzazione di impianti per lavabo o doccia, con miscelazione monocomando o termostatica. Per facilitare e velocizzare la scelta, elenchiamo per ognuno di loro le parti esterne compatibili, che possono essere scelte dall'utente finale e installate anche in un secondo momento.





#### **ALLBOX**

LAVABO MONOCOMANDO ASSIALE	287
LAVABO MONOCOMANDO	289
LAVABO BICOMANDO	301

#### **EASYBOX**

DOCCIA MONOCOMANDO 2 VIE	305
--------------------------	-----

#### **TECHBOX**

DOCCIA MONOCOMANDO 2 VIE	311
DOCCIA MONOCOMANDO 3 VIE	315

#### **WELLBOX**

DOCCIA TERMOSTATICO 1 VIA	319
DOCCIA TERMOSTATICO 2 VIE	323
DOCCIA TERMOSTATICO 3 VIE	327
DOCCIA TERMOSTATICO 4 VIE	331

#### **ONOFF**

DOCCIA TERMOSTATICO 2 VIE	335
---------------------------	-----



ALLBOX

# LAVABO MONOCOMANDO ASSIALE

Centro Stile Nobili

Il corpo incasso universale per lavabo a parete monocomando assiale è compatibile con i miscelatori equipaggiati con la rivoluzionaria cartuccia a immersione totale e movimento assiale Nobili Widd® 2020: un gioiello tecnologico che definisce un cambiamento epocale nella progettazione della rubinetteria di design, consentendo l'entrata, la regolazione di portata e temperatura e l'uscita dell'acqua sullo stesso asse, dando vita a miscelatori contraddistinti da linee essenziali e da un estremo minimalismo stilistico.



**Allbox, parte incasso necessaria**

· Ingresso acqua calda e acqua fredda ø 1/2"

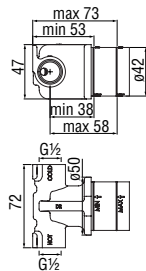

- WE00600 **MOD** 104,00 €

PARTE ESTERNA SOLE

**Parte esterna monocomando a parete**

· Limitatore di energia con apertura in acqua fredda  
 · Aeratore anticalcare M 18,5 x 1, portata 5 l/min  
 · Lunghezza bocca 200 mm  
 · Senza scarico

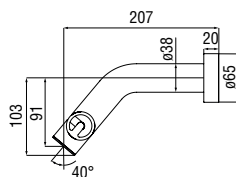

Inox spazzolato	SO130198IX	<b>NEW</b>	495,00 €
Grafite spazzolato PVD	SO130198GUP	<b>NEW</b>	528,00 €
Caffè spazzolato	SO130198SB	<b>NEW</b>	528,00 €
Argilla spazzolato PVD	SO130198RTP	<b>NEW</b>	528,00 €
Cromo lucido	SO130198CR	<b>NEW</b>	330,00 €

RCR2020  
41,00 €

RAEK222/44  
61,00 € - 10 pz.

NR00212/25  
43,00 €

PARTE ESTERNA VELIS

**Parte esterna monocomando a parete**

· Limitatore di energia con apertura in acqua fredda  
 · Aeratore anticalcare M 18 x 1, portata 5 l/min  
 · Lunghezza bocca 200 mm  
 · Senza scarico

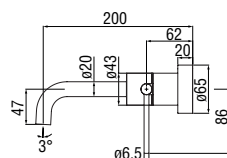

Cromo lucido	VE125198/1CR		260,00 €
Inox spazzolato	VE125198/1IX		391,00 €
Grafite spazzolato PVD	VE125198/1GUP		416,00 €
Miele spazzolato PVD	VE125198/1CGP	<b>NEW</b>	416,00 €
Caffè spazzolato	VE125198/1SB	<b>NEW</b>	416,00 €
Tramonto lucido PVD	VE125198/1RCP		416,00 €
Argilla spazzolato PVD	VE125198/1RTP		416,00 €

RCR2020  
41,00 €

RAEK222/42  
45,00 € - 10 pz.

NR00212/25  
43,00 €

**Parte esterna monocomando a parete**

· Limitatore di energia con apertura in acqua fredda  
 · Aeratore anticalcare M 18 x 1, portata 5 l/min  
 · Lunghezza bocca 200 mm  
 · Senza scarico

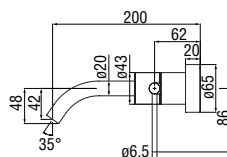

Cromo lucido	VE125199/1CR		258,00 €
Inox spazzolato	VE125199/1IX		387,00 €
Grafite spazzolato PVD	VE125199/1GUP		413,00 €
Miele spazzolato PVD	VE125199/1CGP	<b>NEW</b>	413,00 €
Caffè spazzolato	VE125199/1SB	<b>NEW</b>	413,00 €
Tramonto lucido PVD	VE125199/1RCP		413,00 €
Argilla spazzolato PVD	VE125199/1RTP		413,00 €

RCR2020  
41,00 €

RAEK222/42  
45,00 € - 10 pz.

NR00212/25  
43,00 €

ALLBOX

# LAVABO MONOCOMANDO

Centro Stile Nobili

Il corpo incasso universale per lavabo a parete monocomando, dotato di cartuccia Nobili Widd® garantita 20 anni, offre la massima libertà in termini di estetica e funzionalità: è compatibile con la maggior parte delle collezioni bagno, lasciando all'utente finale la possibilità di scegliere la parte esterna preferita tra un'ampia gamma di proposte, differenti per design, finitura e lunghezza della bocca di erogazione.



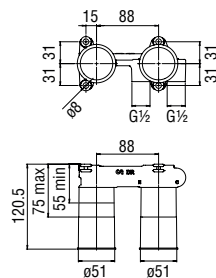

**Allbox, parte incasso necessaria**

- Ingresso acqua calda e acqua fredda ø 1/2"
- Uscita ø 1/2"

- WE00198 **MOD** 125,00 €

**20**  
YEARS  
CARTRIDGE  
WARRANTY

RCR350  
39,00 €

PARTE ESTERNA DRESS

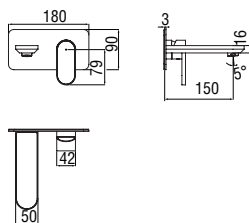

**Parte esterna monocomando a parete**

- Limitatore di portata con freno al 50%
- Aeratore anticalcare M 24 x 1
- Lunghezza bocca 150 mm
- Senza scarico

Cromo and Colour	DSI06198C--	564,00 €
Cromo and Wood	DSI06198C--	732,00 €
Inox T.E.A.+ and Fenix	DSI06198T--	902,00 €
Cromo and Matter	DSI06198C--	902,00 €
Cromo and Carbon	DSI06198C--	1.396,00 €
Inox T.E.A.+ and Carbon	DSI06198T--	1.396,00 €
Cromo and Guilloché	DSI06198C--	1.689,00 €

RAEK220/35CR  
29,00 € - 10 pz.

NR00212/10CR  
43,00 €

**Parte esterna monocomando a parete bocca lunga**

- Limitatore di portata con freno al 50%
- Aeratore anticalcare M 24 x 1
- Lunghezza bocca 200 mm
- Senza scarico

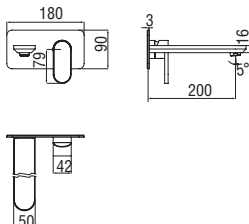

Cromo and Colour	DSI06198/1C--	591,00 €
Cromo and Wood	DSI06198/1C--	758,00 €
Inox T.E.A.+ and Fenix	DSI06198/1T--	928,00 €
Cromo and Matter	DSI06198/1C--	928,00 €
Cromo and Carbon	DSI06198/1C--	1.423,00 €
Inox T.E.A.+ and Carbon	DSI06198/1T--	1.423,00 €
Cromo and Guilloché	DSI06198/1C--	1.716,00 €

RAEK220/35CR  
29,00 € - 10 pz.

NR00212/10CR  
43,00 €

PARTE ESTERNA LIVE

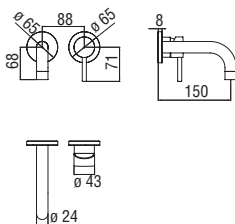

**Parte esterna monocomando a parete**

- Limitatore di portata con freno al 50%
- Aeratore anticalcare M 22 x 1, portata 5 l/min
- Lunghezza bocca 150 mm
- Senza scarico

Cromo lucido	LV00199CR	236,00 €
Inox spazzolato	LV00199IX	353,00 €
Grafite spazzolato PVD	LV00199GUP	<b>NEW</b> 378,00 €
Mora opaco	LV00199BM	353,00 €
Neve opaco	LV00199WM	353,00 €
Miele spazzolato PVD	LV00199CGP	<b>NEW</b> 378,00 €
Argilla spazzolato PVD	LV00199RTP	<b>NEW</b> 378,00 €

RAEK219/67CR  
75,00 € - 10 pz.

NR00212/10CR  
43,00 €

**Parte esterna monocomando a parete bocca lunga**

- Limitatore di portata con freno al 50%
- Aeratore anticalcare M 22 x 1, portata 5 l/min
- Lunghezza bocca 200 mm
- Senza scarico

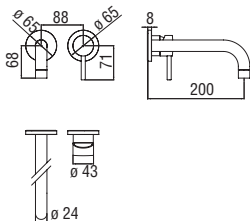

Cromo lucido	LVO0199/1CR	265,00 €
Inox spazzolato	LVO0199/1IX	397,00 €
Grafite spazzolato PVD	LVO0199/1GUP	<b>NEW</b> 424,00 €
Mora opaco	LVO0199/1BM	397,00 €
Neve opaco	LVO0199/1WM	397,00 €
Miele spazzolato PVD	LVO0199/1CGP	<b>NEW</b> 424,00 €
Argilla spazzolato PVD	LVO0199/1RTP	<b>NEW</b> 424,00 €

RAEK219/67CR  
75,00 € - 10 pz.

NR00212/10CR  
43,00 €

**Parte esterna monocomando a parete bocca lunga**

- Limitatore di portata con freno al 50%
- Aeratore anticalcare M 22 x 1, portata 5 l/min
- Lunghezza bocca 250 mm
- Senza scarico

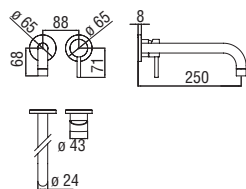

Cromo lucido	LVO0199/2CR	294,00 €
Inox spazzolato	LVO0199/2IX	442,00 €
Grafite spazzolato PVD	LVO0199/2GUP	<b>NEW</b> 470,00 €
Mora opaco	LVO0199/2BM	442,00 €
Neve opaco	LVO0199/2WM	442,00 €
Miele spazzolato PVD	LVO0199/2CGP	<b>NEW</b> 470,00 €
Argilla spazzolato PVD	LVO0199/2RTP	<b>NEW</b> 470,00 €

RAEK219/67CR  
75,00 € - 10 pz.

NR00212/10CR  
43,00 €

**Parte esterna monocomando a parete**

- Limitatore di portata con freno al 50%
- Aeratore anticalcare M 22 x 1, portata 5 l/min
- Lunghezza bocca 150 mm
- Senza scarico

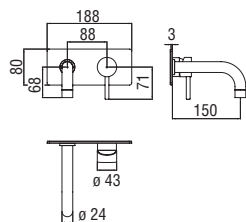

Cromo lucido	LVO0198CR	269,00 €
Inox spazzolato	LVO0198IX	403,00 €
Grafite spazzolato PVD	LVO0198GUP	<b>NEW</b> 430,00 €
Mora opaco	LVO0198BM	403,00 €
Neve opaco	LVO0198WM	403,00 €
Miele spazzolato PVD	LVO0198CGP	<b>NEW</b> 430,00 €
Argilla spazzolato PVD	LVO0198RTP	<b>NEW</b> 430,00 €

RAEK219/67CR  
75,00 € - 10 pz.

NR00212/10CR  
43,00 €

**Parte esterna monocomando a parete bocca lunga**

- Limitatore di portata con freno al 50%
- Aeratore anticalcare M 22 x 1, portata 5 l/min
- Lunghezza bocca 200 mm
- Senza scarico

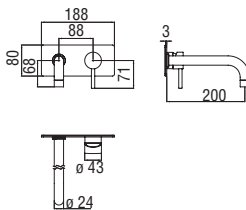

Cromo lucido	LVO0198/1CR	299,00 €
Inox spazzolato	LVO0198/1IX	447,00 €
Grafite spazzolato PVD	LVO0198/1GUP	<b>NEW</b> 478,00 €
Mora opaco	LVO0198/1BM	447,00 €
Neve opaco	LVO0198/1WM	447,00 €
Miele spazzolato PVD	LVO0198/1CGP	<b>NEW</b> 478,00 €
Argilla spazzolato PVD	LVO0198/1RTP	<b>NEW</b> 478,00 €

RAEK219/67CR  
75,00 € - 10 pz.

NR00212/10CR  
43,00 €

PARTE ESTERNA LIVE

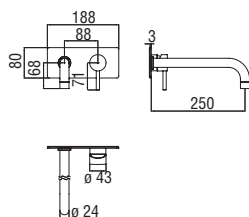

**Parte esterna monocomando a parete bocca lunga**

- Limitatore di portata con freno al 50%
- Aeratore anticalcare M 22 x 1, portata 5 l/min
- Lunghezza bocca 250 mm
- Senza scarico

Cromo lucido	LV00198/2CR	328,00 €
Inox spazzolato	LV00198/2IX	491,00 €
Grafite spazzolato PVD	LV00198/2GUP	<b>NEW</b> 525,00 €
Mora opaco	LV00198/2BM	491,00 €
Neve opaco	LV00198/2WM	491,00 €
Miele spazzolato PVD	LV00198/2CGP	<b>NEW</b> 525,00 €
Argilla spazzolato PVD	LV00198/2RTP	<b>NEW</b> 525,00 €



RAEK219/67CR  
75,00 € - 10 pz.



NR00212/10CR  
43,00 €

PARTE ESTERNA UNO

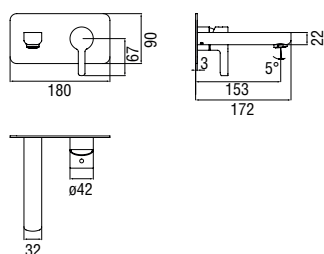

**Parte esterna monocomando a parete**

- Limitatore di portata con freno al 50%
- Aeratore anticalcare M 24 x 1
- Lunghezza bocca 170 mm
- Senza scarico

Cromo lucido	LR116198CR	269,00 €
Mora opaco	LR116198BM	403,00 €



RAEK220/37CR  
47,00 € - 10 pz.



NR00212/10CR  
43,00 €

**Parte esterna monocomando a parete bocca lunga**

- Limitatore di portata con freno al 50%
- Aeratore anticalcare M 24 x 1
- Lunghezza bocca 220 mm
- Senza scarico

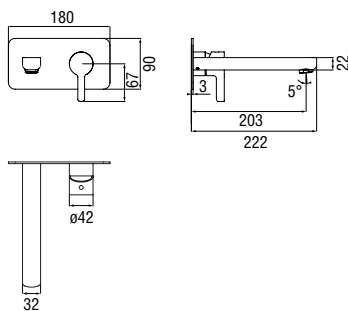

Cromo lucido	LR116198/1CR	299,00 €
Mora opaco	LR116198/1BM	447,00 €



RAEK220/37CR  
47,00 € - 10 pz.



NR00212/10CR  
43,00 €

PARTE ESTERNA YOYO

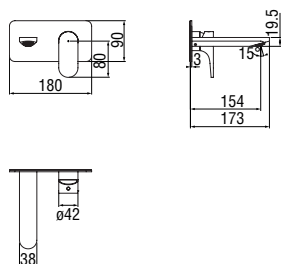

**Parte esterna monocomando a parete**

- Limitatore di portata con freno al 50%
- Aeratore anticalcare M 24 x 1, portata 5 l/min
- Lunghezza bocca 150 mm
- Senza scarico

Cromo lucido	YO126198CR	235,00 €
Mora opaco	YO126198BM	353,00 €



RAEK222/40  
56,00 € - 10 pz.



NR00212/10CR  
43,00 €

PARTE ESTERNA YOYO

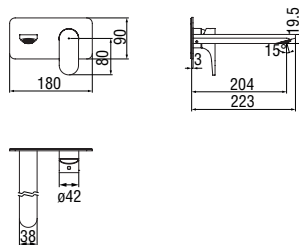

**Parte esterna monocomando a parete bocca lunga**

- Limitatore di portata con freno al 50%
- Aeratore anticalcare M 24 x 1, portata 5 l/min
- Lunghezza bocca 200 mm
- Senza scarico

Cromo lucido	YO126198/1CR	261,00 €
Mora opaco	YO126198/1BM	393,00 €

 RAEK222/40 56,00 € - 10 pz.	 NR00212/10CR 43,00 €
--	---

PARTE ESTERNA SEVEN

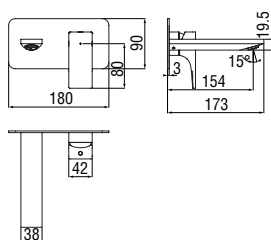

**Parte esterna monocomando a parete**

- Limitatore di portata con freno al 50%
- Aeratore anticalcare M 24 x 1, portata 5 l/min
- Lunghezza bocca 150 mm
- Senza scarico

Cromo lucido	SE124198CR	274,00 €
Inox spazzolato	SE124198IX	<b>NEW</b> 413,00 €
Mora opaco	SE124198BM	413,00 €

 RAEK222/40 56,00 € - 10 pz.	 NR00212/10CR 43,00 €
--	---

PARTE ESTERNA ACQUAVIVA

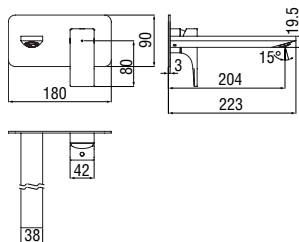

**Parte esterna monocomando a parete bocca lunga**

- Limitatore di portata con freno al 50%
- Aeratore anticalcare M 24 x 1, portata 5 l/min
- Lunghezza bocca 200 mm
- Senza scarico

Cromo lucido	SE124198/1CR	305,00 €
Inox spazzolato	SE124198/1IX	<b>NEW</b> 457,00 €
Mora opaco	SE124198/1BM	457,00 €

 RAEK222/40 56,00 € - 10 pz.	 NR00212/10CR 43,00 €
--	---

PARTE ESTERNA ACQUAVIVA

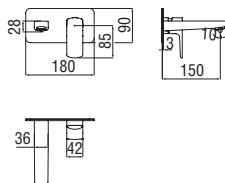

**Parte esterna monocomando a parete**

- Limitatore di portata con freno al 50%
- Aeratore anticalcare M 24 x 1
- Lunghezza bocca 150 mm
- Senza scarico

Cromo lucido	VV103198CR	250,00 €
Mora opaco	VV103198BM	375,00 €

 RAEK220/37CR 47,00 € - 10 pz.	 NR00212/10CR 43,00 €
--	---

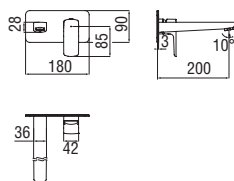

**Parte esterna monocomando a parete bocca lunga**

- Limitatore di portata con freno al 50%
- Aeratore anticalcare M 24 x 1
- Lunghezza bocca 200 mm
- Senza scarico

Cromo lucido	VV103198/1CR	277,00 €
Mora opaco	VV103198/1BM	415,00 €

 RAEK220/37CR  
47,00 € - 10 pz.

 NR00212/10CR  
43,00 €

PARTE ESTERNA LOOP

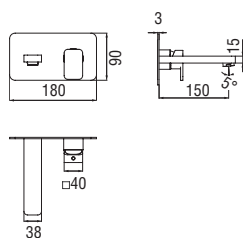

**Parte esterna monocomando a parete**

- Limitatore di portata con freno al 50%
- Aeratore anticalcare M 24 x 1
- Lunghezza bocca 150 mm
- Senza scarico

Cromo lucido	LP90198CR	446,00 €
--------------	-----------	----------

 RAEK220/37CR  
47,00 € - 10 pz.

 NR00212/10CR  
43,00 €

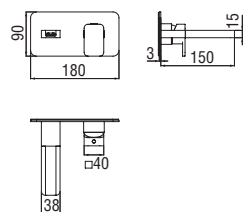

**Parte esterna monocomando a parete bocca a cascata**

- Limitatore di portata con freno al 50%
- Lunghezza bocca 150 mm
- Senza scarico

Cromo lucido	LPC90198CR	501,00 €
--------------	------------	----------

 NR00212/10CR  
43,00 €

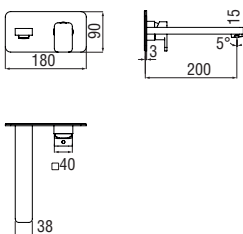

**Parte esterna monocomando a parete bocca lunga**

- Limitatore di portata con freno al 50%
- Aeratore anticalcare M 24 x 1
- Lunghezza bocca 200 mm
- Senza scarico

Cromo lucido	LP90198/1CR	479,00 €
--------------	-------------	----------

 RAEK220/37CR  
47,00 € - 10 pz.

 NR00212/10CR  
43,00 €



PARTE ESTERNA LOOP

**Parte esterna monocomando a parete bocca lunga a cascata**

- Limitatore di portata con freno al 50%
- Lunghezza bocca 200 mm
- Senza scarico

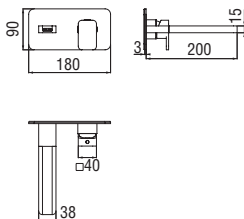

Cromo lucido LPC90198/1CR 528,00 €

 NR00212/10CR  
43,00 €

PARTE ESTERNA UP

**Parte esterna monocomando a parete**

- Limitatore di portata con freno al 50%
- Aeratore anticalcare M 24 x 1
- Lunghezza bocca 150 mm
- Senza scarico

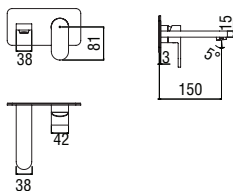

Cromo lucido UP94198CR 246,00 €

Mora opaco UP94198BM 369,00 €

 RAEK220/37CR 47,00 € - 10 pz.

 NR00212/10CR 43,00 €

**Parte esterna monocomando a parete bocca lunga**

- Limitatore di portata con freno al 50%
- Aeratore anticalcare M 24 x 1
- Lunghezza bocca 200 mm
- Senza scarico

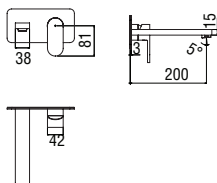

Cromo lucido UP94198/1CR 272,00 €

Mora opaco UP94198/1BM 410,00 €

 RAEK220/37CR 47,00 € - 10 pz.

 NR00212/10CR 43,00 €

PARTE ESTERNA RAY

**Parte esterna monocomando a parete**

- Limitatore di portata con freno al 50%
- Aeratore anticalcare
- Lunghezza bocca 150 mm
- Senza scarico

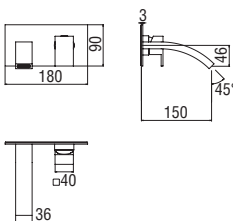

Cromo lucido RY00198CR 537,00 €

 RAEK222/28 93,00 € - 5 pz.

 NR00212/10CR 43,00 €

PARTE ESTERNA RAY

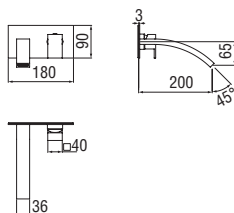

**Parte esterna monocomando a parete bocca lunga**

- Limitatore di portata con freno al 50%
- Aeratore anticalcare
- Lunghezza bocca 200 mm
- Senza scarico

Cromo lucido RY00198/1CR 570,00 €

RAEK222/28  
93,00 € - 5 pz.

NR00212/10CR  
43,00 €

PARTE ESTERNA MIA

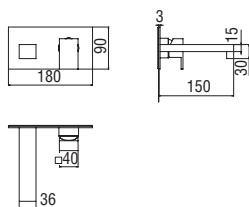

**Parte esterna monocomando a parete**

- Limitatore di portata con freno al 50%
- Aeratore anticalcare
- Lunghezza bocca 150 mm
- Senza scarico

Cromo lucido M1102198CR 559,00 €  
Inox spazzolato M1102198IX 839,00 €  
Mora opaco M1102198BM 839,00 €

RAEK222/28  
93,00 € - 5 pz.

NR00212/10CR  
43,00 €

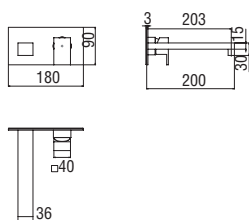

**Parte esterna monocomando a parete bocca lunga**

- Limitatore di portata con freno al 50%
- Aeratore anticalcare
- Lunghezza bocca 200 mm
- Senza scarico

Cromo lucido M1102198/1CR 593,00 €  
Inox spazzolato M1102198/1IX 889,00 €  
Mora opaco M1102198/1BM 889,00 €

RAEK222/28  
93,00 € - 5 pz.

NR00212/10CR  
43,00 €

PARTE ESTERNA SOFI

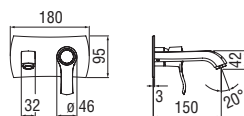

**Parte esterna monocomando a parete**

- Limitatore di portata con freno al 50%
- Aeratore anticalcare M 24 x 1
- Lunghezza bocca 150 mm
- Senza scarico

Cromo lucido SI98198CR 280,00 €  
Caffè spazzolato SI98198SB **NEW** 448,00 €

RAEK220/37CR  
47,00 € - 10 pz.

NR00212/10CR  
43,00 €

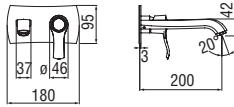

**Parte esterna monocomando a parete bocca lunga**

- Limitatore di portata con freno al 50%
- Aeratore anticalcare M 24 x 1
- Lunghezza bocca 200 mm
- Senza scarico

Cromo lucido	SI98198/1CR	355,00 €
Caffè spazzolato	SI98198/1SB	<b>NEW</b> 568,00 €

 RAEK220/37CR 47,00 € - 10 pz.	 NR00212/10CR 43,00 €
--	---

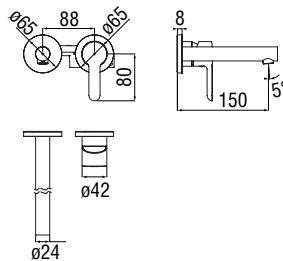

**Parte esterna monocomando a parete**

- Limitatore di portata con freno al 50%
- Aeratore anticalcare M 18 x 1
- Lunghezza bocca 150 mm
- Senza scarico

Cromo lucido	AB87199CR	217,00 €
Mora opaco	AB87199BM	<b>NEW</b> 293,00 €

 RAEK220/27CR 43,00 € - 10 pz.	 NR00212/10CR 43,00 €
--	---

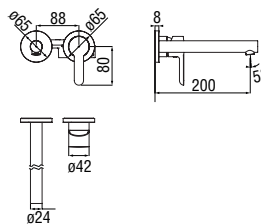

**Parte esterna monocomando a parete bocca lunga**

- Limitatore di portata con freno al 50%
- Aeratore anticalcare M 18 x 1
- Lunghezza bocca 200 mm
- Senza scarico

Cromo lucido	AB87199/1CR	245,00 €
Mora opaco	AB87199/1BM	<b>NEW</b> 331,00 €

 RAEK220/27CR 43,00 € - 10 pz.	 NR00212/10CR 43,00 €
--	---

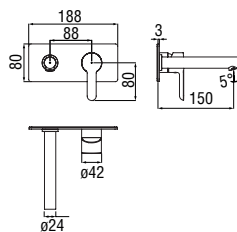

**Parte esterna monocomando a parete**

- Limitatore di portata con freno al 50%
- Aeratore anticalcare M 18 x 1
- Lunghezza bocca 150 mm
- Senza scarico

Cromo lucido	AB87198CR	236,00 €
Mora opaco	AB87198BM	<b>NEW</b> 319,00 €

 RAEK220/27CR 43,00 € - 10 pz.	 NR00212/10CR 43,00 €
--	---

PARTE ESTERNA ABC

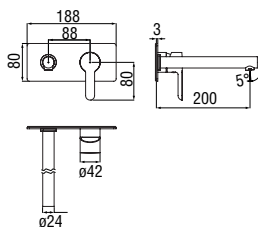

**Parte esterna monocomando a parete bocca lunga**

- Limitatore di portata con freno al 50%
- Aeratore anticalcare M 18 x 1
- Lunghezza bocca 200 mm
- Senza scarico

Cromo lucido	AB87198/1CR	261,00 €
Mora opaco	AB87198/1BM	<b>NEW</b> 352,00 €

 RAEK220/27CR  
43,00 € - 10 pz.

 NR00212/10CR  
43,00 €

PARTE ESTERNA SKY

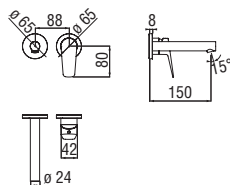

**Parte esterna monocomando a parete**

- Limitatore di portata con freno al 50%
- Aeratore anticalcare M 18 x 1
- Lunghezza bocca 150 mm
- Senza scarico

Cromo lucido	SY97199CR	172,00 €
--------------	-----------	----------

 RAEK220/27CR  
43,00 € - 10 pz.

 NR00212/10CR  
43,00 €

**Parte esterna monocomando a parete bocca lunga**

- Limitatore di portata con freno al 50%
- Aeratore anticalcare M 18 x 1
- Lunghezza bocca 200 mm
- Senza scarico

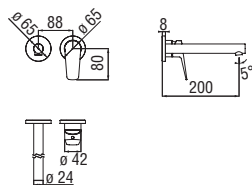

Cromo lucido	SY97199/1CR	193,00 €
--------------	-------------	----------

 RAEK220/27CR  
43,00 € - 10 pz.

 NR00212/10CR  
43,00 €

**Parte esterna monocomando a parete**

- Limitatore di portata con freno al 50%
- Aeratore anticalcare M 18 x 1
- Lunghezza bocca 150 mm
- Senza scarico

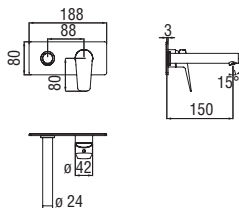

Cromo lucido	SY97198CR	186,00 €
--------------	-----------	----------

 RAEK220/27CR  
43,00 € - 10 pz.

 NR00212/10CR  
43,00 €

**Parte esterna monocomando a parete bocca lunga**

- Limitatore di portata con freno al 50%
- Aeratore anticalcare M 18 x 1
- Lunghezza bocca 200 mm
- Senza scarico

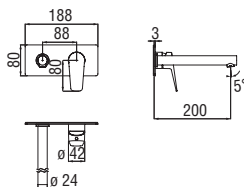

Cromo lucido SY97198/1CR 208,00 €

 RAEK220/27CR  
43,00 € - 10 pz.

 NR00212/10CR  
43,00 €

**Parte esterna monocomando a parete**

- Limitatore di portata con freno al 50%
- Aeratore anticalcare M 18 x 1
- Lunghezza bocca 150 mm
- Senza scarico

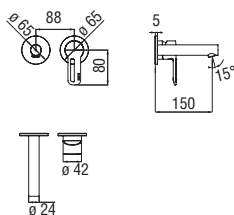

Cromo lucido RD00199CR 226,00 €

 RAEK220/27CR  
43,00 € - 10 pz.

 NR00212/10CR  
43,00 €

**Parte esterna monocomando a parete bocca lunga**

- Limitatore di portata con freno al 50%
- Aeratore anticalcare M 18 x 1
- Lunghezza bocca 200 mm
- Senza scarico

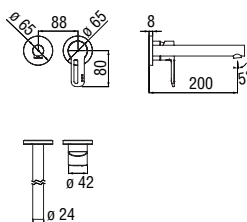

Cromo lucido RD00199/1CR 254,00 €

 RAEK220/27CR  
43,00 € - 10 pz.

 NR00212/10CR  
43,00 €

**Parte esterna monocomando a parete**

- Limitatore di portata con freno al 50%
- Aeratore anticalcare M 18 x 1
- Lunghezza bocca 150 mm
- Senza scarico

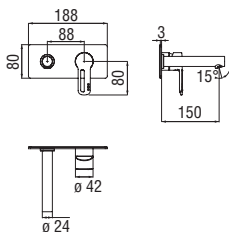

Cromo lucido RD00198CR 244,00 €

 RAEK220/27CR  
43,00 € - 10 pz.

 NR00212/10CR  
43,00 €

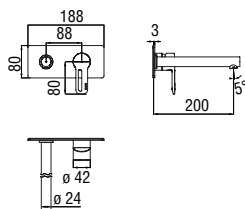

**Parte esterna monocomando a parete bocca lunga**

- Limitatore di portata con freno al 50%
- Aeratore anticalcare M 18 x 1
- Lunghezza bocca 200 mm
- Senza scarico

Cromo lucido RD00198/1CR 270,00 €

 RAEK220/27CR  
43,00 € - 10 pz.

 NR00212/10CR  
43,00 €

ALLBOX

# LAVABO BICOMANDO

Centro Stile Nobili

Il corpo incasso universale per batteria 3 fori a parete semplifica e velocizza i tempi di realizzazione dell'impianto: può essere installato in anticipo lasciando all'utente finale la scelta della parte esterna fra un'ampia gamma di proposte, differenti per design e finitura.



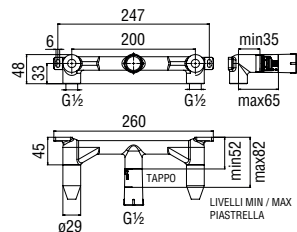
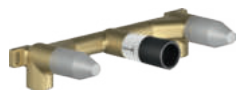

**Allbox, parte incasso necessaria**

- Ingresso acqua calda e acqua fredda ø 1/2"
- Uscita ø 1/2"

WE00298

130,00 €

PARTE ESTERNA SOLE

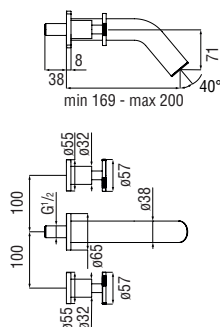

**Parte esterna batteria 3 fori a parete**

- Aeratore anticalcare M 18,5 x 1, portata 5 l/min
- Lunghezza bocca 200 mm
- Senza scarico

Inox spazzolato	SO130298/EIX	<b>NEW</b>	558,00 €
Grafite spazzolato PVD	SO130298/EGUP	<b>NEW</b>	595,00 €
Caffè spazzolato	SO130298/ESB	<b>NEW</b>	595,00 €
Argilla spazzolato PVD	SO130298/ERTP	<b>NEW</b>	595,00 €
Cromo lucido	SO130298/ECR	<b>NEW</b>	372,00 €



RVT200/5D  
18,00 €



RVT200/5S  
18,00 €



RAEK222/44  
61,00 € - 10 pz.



NR00212/28  
41,00 €

PARTE ESTERNA VELIS

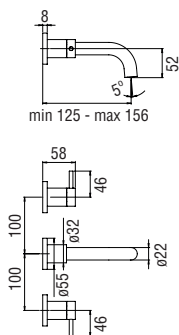

**Parte esterna batteria 3 fori a parete**

- Aeratore anticalcare M 18,5 x 1, portata 5 l/min
- Lunghezza bocca min 125 - max 156 mm
- Senza scarico

Cromo lucido	VE125298/ECR		290,00 €
Inox spazzolato	VE125298/EIX		435,00 €
Grafite spazzolato PVD	VE125298/EGUP		551,00 €
Miele spazzolato PVD	VE125298/ECGP	<b>NEW</b>	551,00 €
Caffè spazzolato	VE125298/ESB	<b>NEW</b>	551,00 €
Tramonto lucido PVD	VE125298/ERCP		551,00 €
Argilla spazzolato PVD	VE125298/ERTP		551,00 €



RVT200/5S  
18,00 €



RVT200/5D  
18,00 €



RAEK222/44  
61,00 € - 10 pz.



NR00212/28  
41,00 €

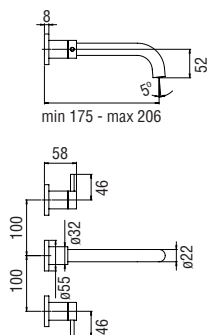

**Parte esterna batteria 3 fori a parete con bocca lunga**

- Aeratore anticalcare M 18,5 x 1, portata 5 l/min
- Lunghezza bocca min 175 - max 206 mm
- Senza scarico

Cromo lucido	VE125298/1ECR		332,00 €
Inox spazzolato	VE125298/1EIX		498,00 €
Grafite spazzolato PVD	VE125298/1EGUP		630,00 €
Miele spazzolato PVD	VE125298/1ECGP	<b>NEW</b>	630,00 €
Caffè spazzolato	VE125298/1ESB	<b>NEW</b>	630,00 €
Tramonto lucido PVD	VE125298/1ERCP		630,00 €
Argilla spazzolato PVD	VE125298/1ERTP		630,00 €



RVT200/5D  
18,00 €



RVT200/5S  
18,00 €



RAEK222/44  
61,00 € - 10 pz.



NR00212/28  
41,00 €



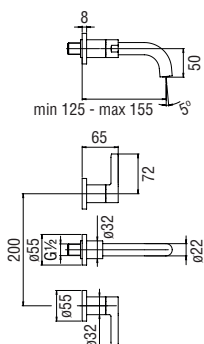

**Parte esterna batteria 3 fori a parete**

- Aeratore anticalcare M 18,5 x 1, portata 5 l/min
- Lunghezza bocca min 125 - max 155 mm
- Senza scarico

Cromo lucido	LR116298/ET1CR	264,00 €
Mora opaco	LR116298/ET1BM	396,00 €

- RVT200/5D 18,00 €
- RVT200/5S 18,00 €
- RAEK222/44 61,00 € - 10 pz.
- NR00212/28 41,00 €

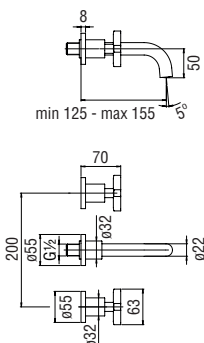

**Parte esterna batteria 3 fori a parete**

- Aeratore anticalcare M 18,5 x 1, portata 5 l/min
- Lunghezza bocca min 125 - max 155 mm
- Senza scarico

Cromo lucido	LR116298/ECR	264,00 €
Grafite spazzolato PVD	LR116298/EGUP	<b>NEW</b> 422,00 €
Mora opaco	LR116298/EBM	396,00 €

- RAEK222/44 61,00 € - 10 pz.
- NR00212/28 41,00 €

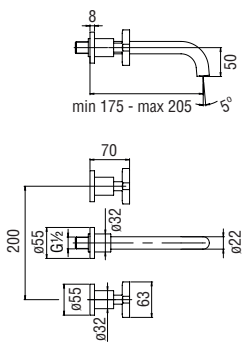

**Parte esterna batteria 3 fori a parete con bocca lunga**

- Aeratore anticalcare M 18,5 x 1, portata 5 l/min
- Lunghezza bocca min 175 - max 205 mm
- Senza scarico

Cromo lucido	LR116298/1ECR	280,00 €
Grafite spazzolato PVD	LR116298/1EGUP	<b>NEW</b> 448,00 €
Mora opaco	LR116298/1EBM	420,00 €

- RAEK222/44 61,00 € - 10 pz.
- NR00212/28 41,00 €

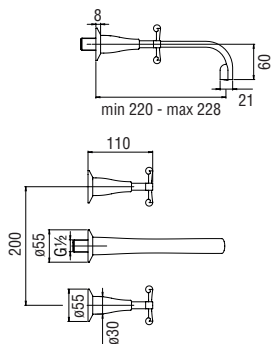

**Parte esterna batteria 3 fori a parete**

- Aeratore anticalcare M 16,5 x 1
- Lunghezza bocca min 220 - max 228 mm
- Senza scarico

Cromo lucido	CP298/ECR		318,00 €
Miele spazzolato PVD	CP298/ECGP	<b>NEW</b>	509,00 €
Caffè spazzolato	CP298/ESB	<b>NEW</b>	509,00 €

 RAEK219/280  
61,00 € - 10 pz.

 NR00212/31CR  
82,00 €

EASYBOX

# DOCCIA MONOCOMANDO 2 VIE

Centro Stile Nobili

Il corpo incasso universale per la creazione di un impianto a 2 vie con miscelazione monocomando, dotato di cartuccia Nobili Widd® garantita 20 anni: può essere installato in anticipo, lasciando all'utente finale la scelta della parte esterna. Dotato delle più recenti tecnologie made in Nobili, è adatto per essere installato sia su pareti in muratura che in cartongesso.



PARTE INCASSO

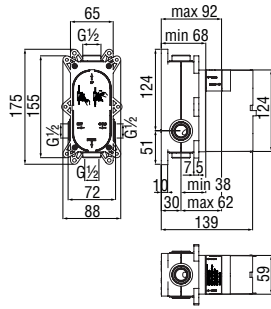

**Easybox 2 vie, parte incasso necessaria**

- Ingresso e uscita acqua  $\varnothing$  1/2"
- Adatta anche a montaggio su cartongesso

Nota: disponibile il dispositivo antireflusso RVREN1717 (opzionale)

- WE81100 135,00 €



CARTRIDGE WARRANTY



RCR350 39,00 €



RVREN1717 33,00 €

PARTE ESTERNA VELIS

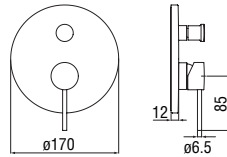

**Parte esterna monocomando incasso a 2 vie**

- Limitatore di portata con freno al 50%
- Deviatore con ritorno automatico
- Tenuta o-ring invisibile, fissaggio a parete impermeabile

Cromo lucido	VE125100/ECR	230,00 €
Inox spazzolato	VE125100/EIX	347,00 €
Grafite spazzolato PVD	VE125100/EGUP	370,00 €
Miele spazzolato PVD	VE125100/ECGP	NEW 370,00 €
Caffè spazzolato	VE125100/ESB	NEW 370,00 €
Tramonto lucido PVD	VE125100/ERCP	370,00 €
Argilla spazzolato PVD	VE125100/ERTP	370,00 €



NR00212/13CR 57,00 €

PARTE ESTERNA DRESS

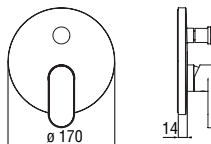

**Parte esterna monocomando incasso a 2 vie**

- Limitatore di portata con freno al 50%
- Deviatore con ritorno automatico
- Tenuta o-ring invisibile
- Fissaggio a parete impermeabile

Cromo and Colour	DS106100/EC--	295,00 €
Cromo and Wood	DS106100/EC--	403,00 €
Inox T.E.A.+ and Fenix	DS106100/ET--	512,00 €
Cromo and Matter	DS106100/EC--	512,00 €
Cromo and Carbon	DS106100/EC--	868,00 €
Inox T.E.A.+ and Carbon	DS106100/ET--	868,00 €
Cromo and Guilloché	DS106100/EC--	1.020,00 €



NR00212/13CR 57,00 €

PARTE ESTERNA LIVE

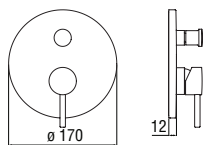

**Parte esterna monocomando incasso a 2 vie**

- Limitatore di portata con freno al 50%
- Deviatore con ritorno automatico
- Tenuta o-ring invisibile, fissaggio a parete impermeabile

Cromo lucido	LV00100/ECR	230,00 €
Inox spazzolato	LV00100/EIX	347,00 €
Grafite spazzolato PVD	LV00100/EGUP	NEW 368,00 €
Mora opaco	LV00100/EBM	347,00 €
Neve opaco	LV00100/EWM	347,00 €
Miele spazzolato PVD	LV00100/ECGP	NEW 368,00 €
Argilla spazzolato PVD	LV00100/ERTP	NEW 368,00 €



NR00212/13CR 57,00 €

**Monocomando incasso a 2 vie**

- Limitatore di portata con freno al 50%
- Deviatore con ritorno automatico

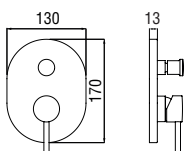

Cromo lucido	AQ93100/ECR	<b>MOD</b>	174,00 €
Inox spazzolato	AQ93100/EIX	<b>MOD</b>	260,00 €
Mora opaco	AQ93100/EBM	<b>NEW</b>	260,00 €



NR00212/13CR  
57,00 €

PARTE ESTERNA UNO

**Parte esterna monocomando incasso a 2 vie**

- Limitatore di portata con freno al 50%
- Deviatore con ritorno automatico
- Tenuta o-ring invisibile
- Fissaggio a parete impermeabile

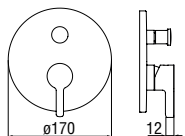

Cromo lucido	LR116100/ECR		229,00 €
Mora opaco	LR116100/EBM		345,00 €



NR00212/13CR  
57,00 €

PARTE ESTERNA YOYO

**Parte esterna monocomando incasso a 2 vie**

- Limitatore di portata con freno al 50%
- Deviatore con ritorno automatico

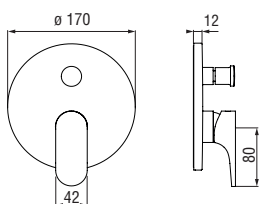

Cromo lucido	YO126100/ECR		139,00 €
Mora opaco	YO126100/EBM		208,00 €



NR00212/13CR  
57,00 €

PARTE ESTERNA SEVEN

**Monocomando incasso a 2 vie**

- Limitatore di portata con freno al 50%
- Deviatore con ritorno automatico

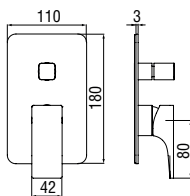

Cromo lucido	SE124100/ECR		162,00 €
Inox spazzolato	SE124100/EIX	<b>NEW</b>	244,00 €
Mora opaco	SE124100/EBM		244,00 €



NR00212/13CR  
57,00 €

PARTE ESTERNA ACQUAVIVA

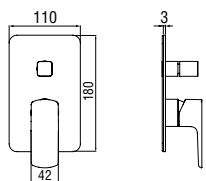

**Monocomando incasso a 2 vie**

- Limitatore di portata con freno al 50%
- Deviatore con ritorno automatico

Cromo lucido	VV103100/ECR	151,00 €
Mora opaco	VV103100/EBM	226,00 €

  
NR00212/13CR  
57,00 €

PARTE ESTERNA LOOP

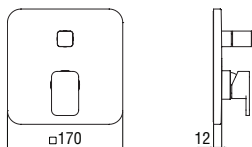

**Parte esterna monocomando incasso a 2 vie**

- Limitatore di portata con freno al 50%
- Deviatore con ritorno automatico
- Tenuta o-ring invisibile
- Fissaggio a parete impermeabile

Cromo lucido	LP90100/ECR	242,00 €
--------------	-------------	----------

  
NR00212/13CR  
57,00 €

PARTE ESTERNA UP

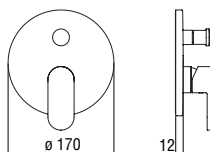

**Parte esterna monocomando incasso a 2 vie**

- Limitatore di portata con freno al 50%
- Deviatore con ritorno automatico
- Tenuta o-ring invisibile
- Fissaggio a parete impermeabile

Cromo lucido	UP94100/ECR	208,00 €
Mora opaco	UP94100/EBM	313,00 €

  
NR00212/13CR  
57,00 €

PARTE ESTERNA RAY

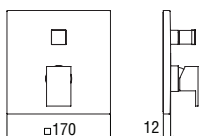

**Parte esterna monocomando incasso a 2 vie**

- Limitatore di portata con freno al 50%
- Deviatore con ritorno automatico
- Tenuta o-ring invisibile
- Fissaggio a parete impermeabile

Cromo lucido	RY00100/ECR	318,00 €
--------------	-------------	----------

  
NR00212/13CR  
57,00 €

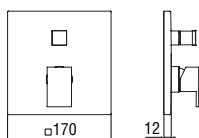

**Parte esterna monocomando incasso a 2 vie**

- Limitatore di portata con freno al 50%
- Deviatore con ritorno automatico
- Tenuta o-ring invisibile
- Fissaggio a parete impermeabile

Cromo lucido	M1102100/ECR	318,00 €
Inox spazzolato	M1102100/EIX	478,00 €
Mora opaco	M1102100/EBM	478,00 €



NR00212/13CR  
57,00 €

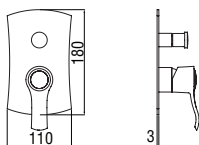

**Parte esterna monocomando incasso a 2 vie**

- Limitatore di portata con freno al 50%
- Deviatore con ritorno automatico

Cromo lucido	S198100/ECR	285,00 €
Caffè spazzolato	S198100/ESB	<b>NEW</b> 456,00 €



NR00212/13CR  
57,00 €





TECHBOX

# DOCCIA MONOCOMANDO 2 VIE

Centro Stile Nobili

Il corpo incasso universale dedicato alla creazione di un impianto a due vie monocomando dotato di deviatore ceramico. Techbox sorprende per le sue ridotte dimensioni e per la sua elevata tecnologia: cartuccia Nobili Widd® garantita 20 anni, tappi di protezione delle parti meccaniche interne, bolla integrata, asole per l'eventuale montaggio su pareti in cartongesso.



PARTE INCASSO

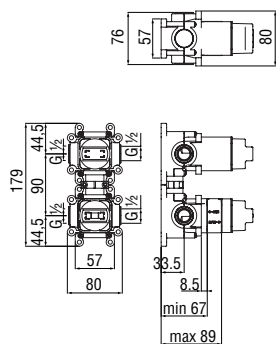

**Techbox 2 vie, parte incasso necessaria**

- Deviatore a 2 vie ceramico
- Ingresso e uscita acqua ø 1/2"
- Adatta anche a montaggio su cartongesso

- WE81102 160,00 €



CARTRIDGE WARRANTY



RCR350 39,00 €



RCR201/35FSC 39,00 €



NR00212/30 85,00 €

PARTE ESTERNA SOLE

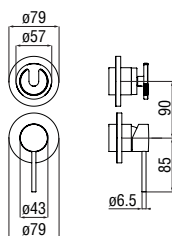

**Parte esterna monocomando incasso a 2-3 vie**

- Limitatore di portata con freno al 50%
- Tenuta o-ring invisibile, fissaggio a parete impermeabile

Inox spazzolato	WE81102/ISOIX	<b>NEW</b>	615,00 €
Grafite spazzolato PVD	WE81102/ISOGUP	<b>NEW</b>	656,00 €
Caffè spazzolato	WE81102/ISOSB	<b>NEW</b>	656,00 €
Argilla spazzolato PVD	WE81102/ISORTP	<b>NEW</b>	656,00 €
Cromo lucido	WE81102/ISO CR	<b>NEW</b>	410,00 €

PARTE ESTERNA VELIS

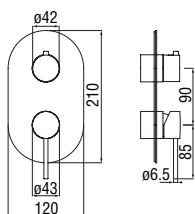

**Parte esterna monocomando incasso a 2-3 vie**

- Limitatore di portata con freno al 50%
- Tenuta o-ring invisibile, fissaggio a parete impermeabile

Cromo lucido	WE81102/VECR		413,00 €
Inox spazzolato	WE81102/VEIX		618,00 €
Grafite spazzolato PVD	WE81102/VEGUP		660,00 €
Miele spazzolato PVD	WE81102/VEGCP	<b>NEW</b>	660,00 €
Caffè spazzolato	WE81102/VESB	<b>NEW</b>	660,00 €
Tramonto lucido PVD	WE81102/VERCP		660,00 €
Argilla spazzolato PVD	WE81102/VERTP		660,00 €

PARTE ESTERNA DRESS

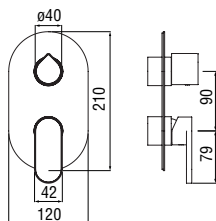

**Parte esterna monocomando incasso a 2-3 vie**

- Limitatore di portata con freno al 50%
- Tenuta o-ring invisibile
- Fissaggio a parete impermeabile

Cromo and Colour	WE81102/DSC--		589,00 €
Cromo and Wood	WE81102/DSC--		759,00 €
Inox T.E.A.+ and Fenix	WE81102/DST--		931,00 €
Cromo and Matter	WE81102/DSC--		931,00 €
Cromo and Carbon	WE81102/DSC--		1.429,00 €
Inox T.E.A.+ and Carbon	WE81102/DST--		1.429,00 €
Cromo and Guilloché	WE81102/DSC--		1.729,00 €

**Parte esterna monocomando incasso a 2-3 vie**

- Limitatore di portata con freno al 50%
- Tenuta o-ring invisibile, fissaggio a parete impermeabile

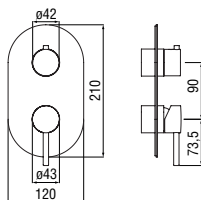

Cromo lucido	WE81102/TCR	413,00 €
Inox spazzolato	WE81102/TIX	618,00 €
Grafite spazzolato PVD	WE81102/TGUP	NEW 661,00 €
Mora opaco	WE81102/TBM	618,00 €
Neve opaco	WE81102/TWM	618,00 €
Miele spazzolato PVD	WE81102/TCGP	NEW 661,00 €
Argilla spazzolato PVD	WE81102/TRTP	NEW 661,00 €

PARTE ESTERNA UNO

**Parte esterna monocomando incasso a 2-3 vie**

- Limitatore di portata con freno al 50%
- Tenuta o-ring invisibile
- Fissaggio a parete impermeabile

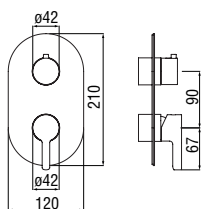

Cromo lucido	WE81102/LRCR	413,00 €
Mora opaco	WE81102/LRBM	618,00 €

PARTE ESTERNA SEVEN

**Parte esterna monocomando incasso a 2-3 vie**

- Limitatore di portata con freno al 50%
- Tenuta o-ring invisibile
- Fissaggio a parete impermeabile

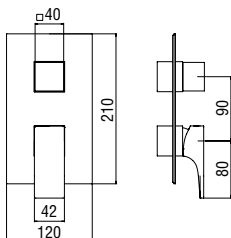

Cromo lucido	WE81102/SECR	398,00 €
Inox spazzolato	WE81102/SEIX	NEW 597,00 €
Mora opaco	WE81102/SEBM	597,00 €

PARTE ESTERNA LOOP

**Parte esterna monocomando incasso a 2-3 vie**

- Limitatore di portata con freno al 50%
- Tenuta o-ring invisibile
- Fissaggio a parete impermeabile

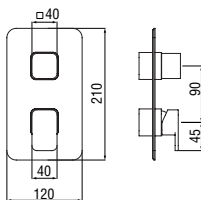

Cromo lucido	WE81102/LPCR	430,00 €
--------------	--------------	----------

PARTE ESTERNA UP

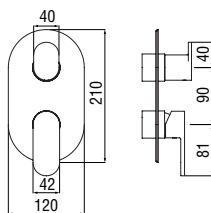

Parte esterna monocomando incasso a 2-3 vie

- Limitatore di portata con freno al 50%
- Tenuta o-ring invisibile
- Fissaggio a parete impermeabile

Cromo lucido	WE81102/UPCR	410,00 €
Mora opaco	WE81102/UPBM	615,00 €

PARTE ESTERNA RAY - MIA

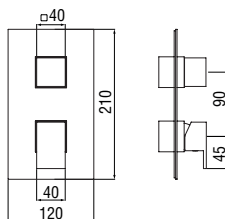

Parte esterna monocomando incasso a 2-3 vie

- Limitatore di portata con freno al 50%
- Tenuta o-ring invisibile
- Fissaggio a parete impermeabile

Cromo lucido	WE81102/QCR	420,00 €
Inox spazzolato	WE81102/QIX	630,00 €
Mora opaco	WE81102/QBM	630,00 €

PARTE ESTERNA SOFÌ

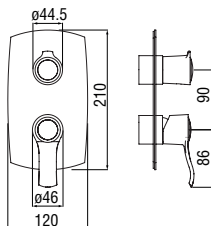

Parte esterna monocomando incasso a 2-3 vie

- Limitatore di portata con freno al 50%
- Tenuta o-ring invisibile
- Fissaggio a parete impermeabile

Cromo lucido	WE81102/SICR	415,00 €
Caffè spazzolato	WE81102/SISB	<b>NEW</b> 664,00 €

TECHBOX

# DOCCIA MONOCOMANDO 3 VIE

Centro Stile Nobili

Techbox 3 vie è il corpo incasso universale destinato alla creazione di un impianto a tre vie monocomando dotato di deviatore ceramico. Massima tecnologia e affidabilità, in un corpo dagli ingombri ridotti: cartuccia Nobili Widd® garantita 20 anni, tappi di protezione delle parti meccaniche interne, bolla integrata, asole per l'eventuale montaggio su pareti in cartongesso.



PARTE INCASSO

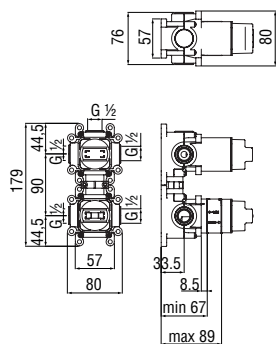

**Techbox 3 vie, parte incasso necessaria**

- Deviatore a 3 vie ceramico
- Ingresso e uscita acqua ø 1/2"
- Adatta anche a montaggio su cartongesso

- WE81103 184,00 €



CARTRIDGE WARRANTY



RCR350 39,00 €



RCR201/35C 39,00 €



NR00212/32 85,00 €

PARTE ESTERNA SOLE

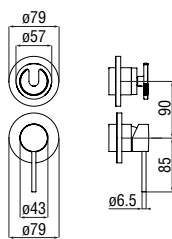

**Parte esterna monocomando incasso a 2-3 vie**

- Limitatore di portata con freno al 50%
- Tenuta o-ring invisibile, fissaggio a parete impermeabile

Inox spazzolato	WE81102/ISOIX	<b>NEW</b>	615,00 €
Grafite spazzolato PVD	WE81102/ISOGUP	<b>NEW</b>	656,00 €
Caffè spazzolato	WE81102/ISOSB	<b>NEW</b>	656,00 €
Argilla spazzolato PVD	WE81102/ISORTP	<b>NEW</b>	656,00 €
Cromo lucido	WE81102/ISO CR	<b>NEW</b>	410,00 €

PARTE ESTERNA VELIS

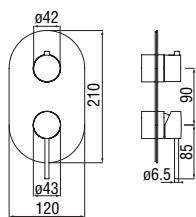

**Parte esterna monocomando incasso a 2-3 vie**

- Limitatore di portata con freno al 50%
- Tenuta o-ring invisibile, fissaggio a parete impermeabile

Cromo lucido	WE81102/VECR		413,00 €
Inox spazzolato	WE81102/VEIX		618,00 €
Grafite spazzolato PVD	WE81102/VEGUP		660,00 €
Miele spazzolato PVD	WE81102/VEGCP	<b>NEW</b>	660,00 €
Caffè spazzolato	WE81102/VESB	<b>NEW</b>	660,00 €
Tramonto lucido PVD	WE81102/VERCP		660,00 €
Argilla spazzolato PVD	WE81102/VERTP		660,00 €

PARTE ESTERNA DRESS

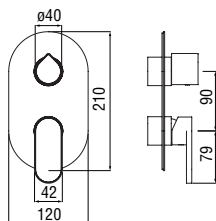

**Parte esterna monocomando incasso a 2-3 vie**

- Limitatore di portata con freno al 50%
- Tenuta o-ring invisibile
- Fissaggio a parete impermeabile

Cromo and Colour	WE81102/DSC--		589,00 €
Cromo and Wood	WE81102/DSC--		759,00 €
Inox T.E.A.+ and Fenix	WE81102/DST--		931,00 €
Cromo and Matter	WE81102/DSC--		931,00 €
Cromo and Carbon	WE81102/DSC--		1.429,00 €
Inox T.E.A.+ and Carbon	WE81102/DST--		1.429,00 €
Cromo and Guilloché	WE81102/DSC--		1.729,00 €

**Parte esterna monocomando incasso a 2-3 vie**

- Limitatore di portata con freno al 50%
- Tenuta o-ring invisibile, fissaggio a parete impermeabile

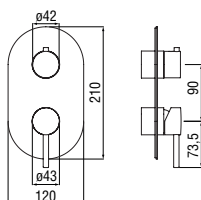

Cromo lucido	WE81102/TCR	413,00 €
Inox spazzolato	WE81102/TIX	618,00 €
Grafite spazzolato PVD	WE81102/TGUP	NEW 661,00 €
Mora opaco	WE81102/TBM	618,00 €
Neve opaco	WE81102/TWM	618,00 €
Miele spazzolato PVD	WE81102/TCGP	NEW 661,00 €
Argilla spazzolato PVD	WE81102/TRTP	NEW 661,00 €

PARTE ESTERNA UNO

**Parte esterna monocomando incasso a 2-3 vie**

- Limitatore di portata con freno al 50%
- Tenuta o-ring invisibile
- Fissaggio a parete impermeabile

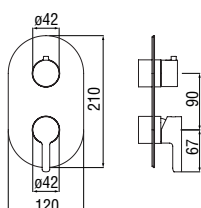

Cromo lucido	WE81102/LRCR	413,00 €
Mora opaco	WE81102/LRBM	618,00 €

PARTE ESTERNA SEVEN

**Parte esterna monocomando incasso a 2-3 vie**

- Limitatore di portata con freno al 50%
- Tenuta o-ring invisibile
- Fissaggio a parete impermeabile

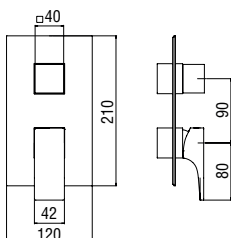

Cromo lucido	WE81102/SECR	398,00 €
Inox spazzolato	WE81102/SEIX	NEW 597,00 €
Mora opaco	WE81102/SEBM	597,00 €

PARTE ESTERNA LOOP

**Parte esterna monocomando incasso a 2-3 vie**

- Limitatore di portata con freno al 50%
- Tenuta o-ring invisibile
- Fissaggio a parete impermeabile

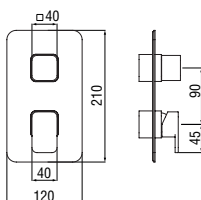

Cromo lucido	WE81102/LPCR	430,00 €
--------------	--------------	----------

PARTE ESTERNA UP

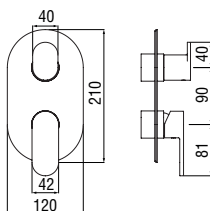

**Parte esterna monocomando incasso a 2-3 vie**

- Limitatore di portata con freno al 50%
- Tenuta o-ring invisibile
- Fissaggio a parete impermeabile

Cromo lucido	WE81102/UPCR	410,00 €
Mora opaco	WE81102/UPBM	615,00 €

PARTE ESTERNA RAY - MIA

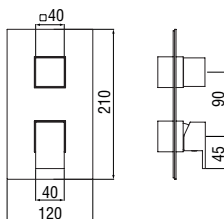

**Parte esterna monocomando incasso a 2-3 vie**

- Limitatore di portata con freno al 50%
- Tenuta o-ring invisibile
- Fissaggio a parete impermeabile

Cromo lucido	WE81102/QCR	420,00 €
Inox spazzolato	WE81102/QIX	630,00 €
Mora opaco	WE81102/QBM	630,00 €

PARTE ESTERNA SOFÌ

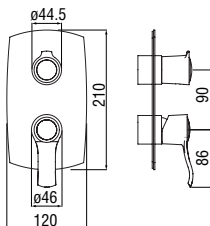

**Parte esterna monocomando incasso a 2-3 vie**

- Limitatore di portata con freno al 50%
- Tenuta o-ring invisibile
- Fissaggio a parete impermeabile

Cromo lucido	WE81102/SICR	415,00 €
Caffè spazzolato	WE81102/SISB	<b>NEW</b> 664,00 €



WELLBOX

# DOCCIA TERMOSTATICO 1 VIA

Centro Stile Nobili

Confortevole semplicità: Wellbox 1 via è consigliato per creare uno spazio doccia con asta murale o set doccia, scegliendo tra una vasta gamma di proposte. La cartuccia termostatica Nobili permette il massimo comfort d'utilizzo in ogni condizione, mentre la possibilità di montaggio su cartongesso (sia verticale che orizzontale) così come il collegamento delle tubature a sinistra o destra, ne ampliano notevolmente il range di utilizzo.



PARTE INCASSO

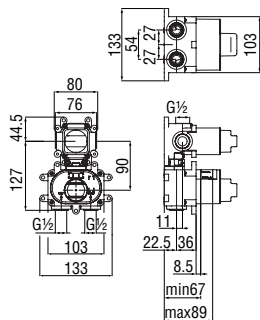

Parte incasso necessaria a 1 via

- Ingresso e uscita acqua  $\varnothing$  1/2"
- Rubinetti di chiusura
- Valvole antiritorno
- Adatta anche a montaggio su cartongesso
- Filtri di ricambio cartuccia inclusi nella confezione

- WE00101 167,00 €

 RCR201/5  
58,00 €

 RVT200/5D  
18,00 €

PARTE ESTERNA SOLE

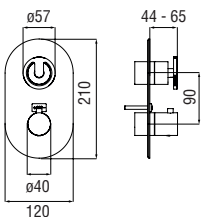

Parte esterna termostatico a 1-2 vie

- Blocco di sicurezza 38° C
- Montaggio verticale o orizzontale

Inox spazzolato	SOI30101IX	<b>NEW</b>	690,00 €
Grafite spazzolato PVD	SOI30101GUP	<b>NEW</b>	736,00 €
Caffè spazzolato	SOI30101SB	<b>NEW</b>	736,00 €
Argilla spazzolato PVD	SOI30101RTP	<b>NEW</b>	736,00 €
Cromo lucido	SOI30101CR	<b>NEW</b>	460,00 €

 NR00008  
34,00 €

PARTE ESTERNA VELIS - LIVE

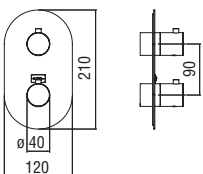

Parte esterna termostatico a 1 via

- Blocco di sicurezza 38° C
- Montaggio verticale o orizzontale

Cromo lucido	WE00101/TCR		414,00 €
Inox spazzolato	WE00101/TIX		621,00 €
Grafite spazzolato PVD	WE00101/TGUP		662,00 €
Mora opaco	WE00101/TBM		621,00 €
Neve opaco	WE00101/TWM		621,00 €
Miele spazzolato PVD	WE00101/TCGP	<b>NEW</b>	662,00 €
Caffè spazzolato	WE00101/TSB	<b>NEW</b>	662,00 €
Tramonto lucido PVD	WE00101/TRCP		662,00 €
Argilla spazzolato PVD	WE00101/TRTP		662,00 €

 NR00008  
34,00 €

PARTE ESTERNA DRESS

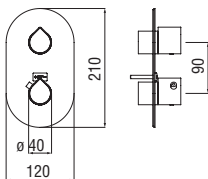

Parte esterna termostatico a 1 via

- Blocco di sicurezza 38° C
- Montaggio verticale o orizzontale

Cromo and Colour	DS106101C--		629,00 €
Cromo and Wood	DS106101C--		732,00 €
Inox T.E.A.+ and Fenix	DS106101T--		837,00 €
Cromo and Matter	DS106101C--		837,00 €
Cromo and Carbon	DS106101C--		1.180,00 €
Inox T.E.A.+ and Carbon	DS106101T--		1.180,00 €
Cromo and Guilloché	DS106101C--		1.323,00 €

 NR00008  
34,00 €

PARTE ESTERNA LIKID

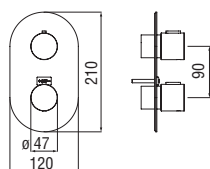

**Parte esterna termostatico a 1 via**

- Blocco di sicurezza 38° C
- Montaggio verticale o orizzontale

Cromo lucido LK00101CR 417,00 €



NR00008  
34,00 €

PARTE ESTERNA YOYO - UP

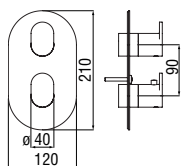

**Parte esterna termostatico a 1 via**

- Blocco di sicurezza 38° C
- Montaggio verticale o orizzontale

Cromo lucido UP94101CR 379,00 €

Mora opaco UP94101BM 570,00 €



NR00008  
34,00 €

PARTE ESTERNA LOOP

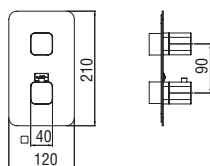

**Parte esterna termostatico a 1 via**

- Blocco di sicurezza 38° C
- Montaggio verticale o orizzontale

Cromo lucido LP90101CR 525,00 €



NR00008  
34,00 €

PARTE ESTERNA SEVEN - RAY - MIA

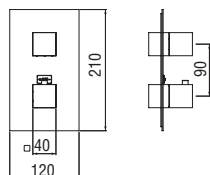

**Parte esterna termostatico a 1 via**

- Blocco di sicurezza 38° C
- Montaggio verticale o orizzontale

Cromo lucido WE00101/QCR 519,00 €

Inox spazzolato WE00101/QIX 779,00 €

Mora opaco WE00101/QBM 779,00 €



NR00008  
34,00 €

PARTE ESTERNA SOFÌ

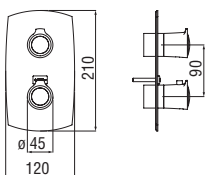

**Parte esterna termostatico a 1 via**

- Blocco di sicurezza 38° C
- Montaggio verticale o orizzontale

Cromo lucido	SI98101CR	417,00 €
Caffè spazzolato	SI98101SB	<b>NEW</b> 667,00 €

 NR00008  
34,00 €

PARTE ESTERNA LIRA

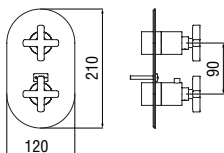

**Parte esterna termostatico a 1 via**

- Blocco di sicurezza 38° C
- Montaggio verticale o orizzontale

Cromo lucido	LR116101CR	463,00 €
Grafite spazzolato PVD	LR116101GUP	<b>NEW</b> 741,00 €
Mora opaco	LR116101BM	695,00 €

 NR00008  
34,00 €

PARTE ESTERNA CARLOS PRIMERO

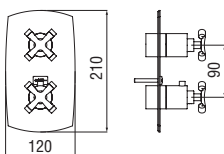

**Parte esterna termostatico a 1 via**

- Blocco di sicurezza 38° C
- Montaggio verticale o orizzontale

Cromo lucido	CP101CR	442,00 €
Miele spazzolato PVD	CP101CGP	<b>NEW</b> 707,00 €
Caffè spazzolato	CP101SB	<b>NEW</b> 707,00 €

 NR00008  
34,00 €

PARTE ESTERNA GRAZIA

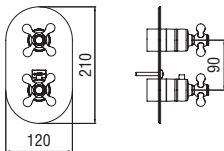

**Parte esterna termostatico a 1 via**

- Blocco di sicurezza 38° C
- Montaggio verticale o orizzontale

Cromo lucido	GRC5101CR	442,00 €
Miele spazzolato PVD	GRC5101CGP	<b>NEW</b> 707,00 €

 NR00008  
34,00 €

WELLBOX

# DOCCIA TERMOSTATICO 2 VIE

Centro Stile Nobili

Razionale concezione dello spazio: Wellbox 2 vie è ideale per la creazione di un ambiente con soffione e set doccia (o asta murale). Il blocco di sicurezza a 38° previene eventuali rischi di scottatura in caso di improvvisa mancanza di acqua fredda, mentre la possibilità di montaggio su cartongesso (sia verticale che orizzontale) così come il collegamento delle tubature a sinistra o destra, ne ampliano notevolmente il range di utilizzo.



PARTE INCASSO

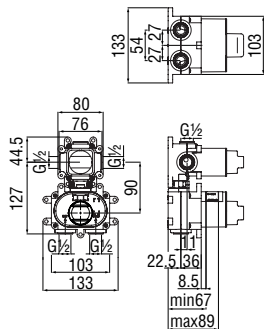

Parte incasso necessaria a 2 vie

- Ingresso e uscita acqua  $\varnothing$  1/2"
- Rubinetti di chiusura
- Valvole antiritorno
- Adatta anche a montaggio su cartongesso
- Filtri di ricambio cartuccia inclusi nella confezione

- WE00102 215,00 €

 RCR201/5  
58,00 €

 RCR201/28  
39,00 €

PARTE ESTERNA SOLE

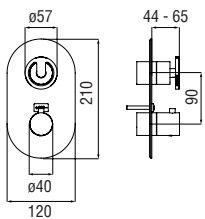

Parte esterna termostatico a 1-2 vie

- Blocco di sicurezza 38° C
- Montaggio verticale o orizzontale

Inox spazzolato	SOI30101IX	<b>NEW</b>	690,00 €
Grafite spazzolato PVD	SOI30101GUP	<b>NEW</b>	736,00 €
Caffè spazzolato	SOI30101SB	<b>NEW</b>	736,00 €
Argilla spazzolato PVD	SOI30101RTP	<b>NEW</b>	736,00 €
Cromo lucido	SOI30101CR	<b>NEW</b>	460,00 €

 NR00008  
34,00 €

PARTE ESTERNA VELIS - LIVE

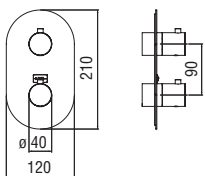

Parte esterna termostatico a 2 vie

- Blocco di sicurezza 38° C
- Montaggio verticale o orizzontale

Cromo lucido	WE00102/TCR	414,00 €
Inox spazzolato	WE00102/TIX	621,00 €
Grafite spazzolato PVD	WE00102/TGUP	662,00 €
Mora opaco	WE00102/TBM	621,00 €
Neve opaco	WE00102/TWM	621,00 €
Miele spazzolato PVD	WE00102/TCGP	<b>NEW</b> 662,00 €
Caffè spazzolato	WE00102/TSB	<b>NEW</b> 662,00 €
Tramonto lucido PVD	WE00102/TRCP	662,00 €
Argilla spazzolato PVD	WE00102/TRTP	662,00 €

 NR00008  
34,00 €

PARTE ESTERNA DRESS

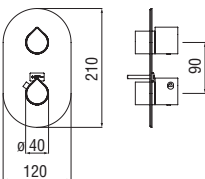

Parte esterna termostatico a 2 vie

- Blocco di sicurezza 38° C
- Montaggio verticale o orizzontale

Cromo and Colour	DS106102C--	629,00 €
Cromo and Wood	DS106102C--	732,00 €
Inox T.E.A.+ and Fenix	DS106102T--	837,00 €
Cromo and Matter	DS106102C--	837,00 €
Cromo and Carbon	DS106102C--	1.180,00 €
Inox T.E.A.+ and Carbon	DS106102T--	1.180,00 €
Cromo and Guilloché	DS106102C--	1.323,00 €

 NR00008  
34,00 €

PARTE ESTERNA LIKID

**Parte esterna termostatico a 2 vie**

- Blocco di sicurezza 38° C
- Montaggio verticale o orizzontale

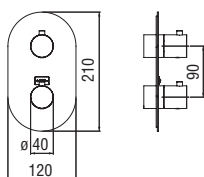

Cromo lucido LK00102CR 417,00 €

  
NR00008  
34,00 €

PARTE ESTERNA YOYO - UP

**Parte esterna termostatico a 2 vie**

- Blocco di sicurezza 38° C
- Montaggio verticale o orizzontale

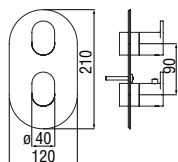

Cromo lucido UP94102CR 379,00 €

Mora opaco UP94102BM 570,00 €

  
NR00008  
34,00 €

PARTE ESTERNA LOOP

**Parte esterna termostatico a 2 vie**

- Blocco di sicurezza 38° C
- Montaggio verticale o orizzontale

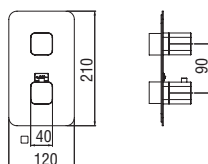

Cromo lucido LP90102CR 525,00 €

  
NR00008  
34,00 €

PARTE ESTERNA SEVEN - RAY - MIA

**Parte esterna termostatico a 2 vie**

- Blocco di sicurezza 38° C
- Montaggio verticale o orizzontale

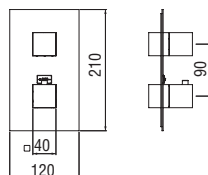

Cromo lucido WE00102/QCR 519,00 €

Inox spazzolato WE00102/QIX 779,00 €

Mora opaco WE00102/QBM 779,00 €

  
NR00008  
34,00 €

PARTE ESTERNA SOFÌ

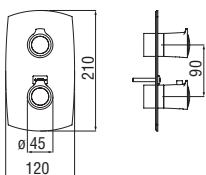

**Parte esterna termostatico a 2 vie**

- Blocco di sicurezza 38° C
- Montaggio verticale o orizzontale

Cromo lucido	SI98102CR	417,00 €
Caffè spazzolato	SI98102SB	<b>NEW</b> 667,00 €



NR00008  
34,00 €

PARTE ESTERNA LIRA

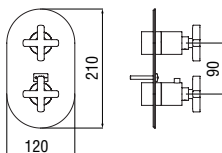

**Parte esterna termostatico a 2 vie**

- Blocco di sicurezza 38° C
- Montaggio verticale o orizzontale

Cromo lucido	LR116102CR	463,00 €
Grafite spazzolato PVD	LR116102GUP	<b>NEW</b> 741,00 €
Mora opaco	LR116102BM	695,00 €



NR00008  
34,00 €

PARTE ESTERNA CARLOS PRIMERO

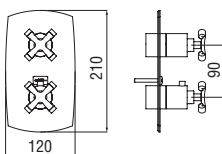

**Parte esterna termostatico a 2 vie**

- Blocco di sicurezza 38° C
- Montaggio verticale o orizzontale

Cromo lucido	CP102CR	442,00 €
Miele spazzolato PVD	CP102CGP	<b>NEW</b> 707,00 €
Caffè spazzolato	CP102SB	<b>NEW</b> 707,00 €



NR00008  
34,00 €

PARTE ESTERNA GRAZIA

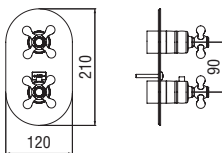

**Parte esterna termostatico a 2 vie**

- Blocco di sicurezza 38° C
- Montaggio verticale o orizzontale

Cromo lucido	GRC5102CR	442,00 €
Miele spazzolato PVD	GRC5102CGP	<b>NEW</b> 707,00 €



NR00008  
34,00 €



WELLBOX

# DOCCIA TERMOSTATICO 3 VIE

Centro Stile Nobili

Wellbox 3 vie permette svariate possibilità, abbinando a proprio piacere soffione (a 1 o 2 getti), set doccia o asta murale, bodyjet (in caso di soffione a 1 getto). La cartuccia termostatica Nobili permette il comfort più totale evitando eventuali rischi di scottatura, mentre la possibilità di montaggio su cartongesso (sia verticale che orizzontale) così come il collegamento delle tubature a sinistra o destra, rendono estremamente versatile questa soluzione.



PARTE INCASSO

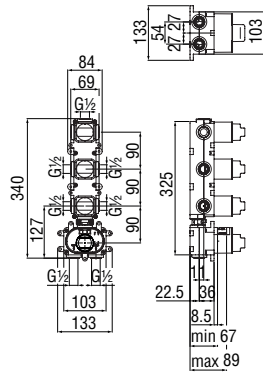

Parte incasso necessaria a 3 vie

- Ingresso e uscita acqua  $\varnothing$  1/2"
- Rubinetti di chiusura
- Valvole antiritorno
- Adatta anche a montaggio su cartongesso
- Filtri di ricambio cartuccia inclusi nella confezione

- WE00103 318,00 €

RCR201/5  
58,00 €

RVT200/5D  
18,00 €

PARTE ESTERNA SOLE

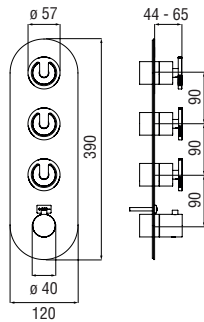

Parte esterna termostatico a 3-4 vie

- Blocco di sicurezza 38° C
- Montaggio verticale o orizzontale

Inox spazzolato	SO130103IX	<b>NEW</b>	1.428,00 €
Grafite spazzolato PVD	SO130103GUP	<b>NEW</b>	1.523,00 €
Caffè spazzolato	SO130103SB	<b>NEW</b>	1.523,00 €
Argilla spazzolato PVD	SO130103RTP	<b>NEW</b>	1.523,00 €
Cromo lucido	SO130103CR	<b>NEW</b>	952,00 €

NR00008  
34,00 €

PARTE ESTERNA VELIS - LIVE

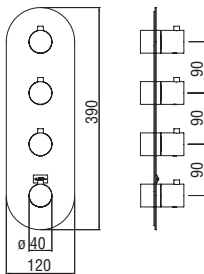

Parte esterna termostatico a 3 vie

- Blocco di sicurezza 38° C
- Montaggio verticale o orizzontale

Cromo lucido	WE00103/TCR	856,00 €
Inox spazzolato	WE00103/TIX	1.283,00 €
Grafite spazzolato PVD	WE00103/TGUP	1.368,00 €
Mora opaco	WE00103/TBM	1.283,00 €
Neve opaco	WE00103/TWM	1.283,00 €
Miele spazzolato PVD	WE00103/TCGP	<b>NEW</b> 1.368,00 €
Caffè spazzolato	WE00103/TSB	<b>NEW</b> 1.368,00 €
Tramonto lucido PVD	WE00103/TRCP	1.368,00 €
Argilla spazzolato PVD	WE00103/TRTP	1.368,00 €

NR00008  
34,00 €

PARTE ESTERNA DRESS

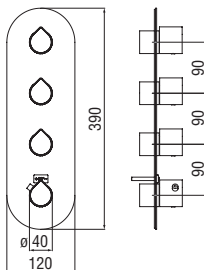

Parte esterna termostatico a 3 vie

- Blocco di sicurezza 38° C
- Montaggio verticale o orizzontale

Cromo and Colour	DS106103C--	993,00 €
Cromo and Wood	DS106103C--	1.240,00 €
Inox T.E.A.+ and Fenix	DS106103T--	1.490,00 €
Cromo and Matter	DS106103C--	1.490,00 €
Cromo and Carbon	DS106103C--	2.171,00 €
Inox T.E.A.+ and Carbon	DS106103T--	2.171,00 €
Cromo and Guilloché	DS106103C--	2.652,00 €

NR00008  
34,00 €

PARTE ESTERNA LIKID

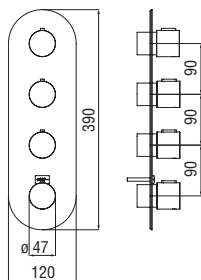

**Parte esterna termostatico a 3 vie**

- Blocco di sicurezza 38° C
- Montaggio verticale o orizzontale

Cromo lucido LK00103CR 845,00 €

  
NR00008  
34,00 €

PARTE ESTERNA YOYO - UP

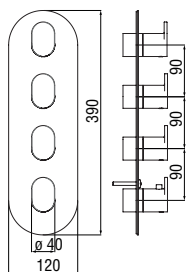

**Parte esterna termostatico a 3 vie**

- Blocco di sicurezza 38° C
- Montaggio verticale o orizzontale

Cromo lucido UP94103CR 783,00 €

Mora opaco UP94103BM 1.174,00 €

  
NR00008  
34,00 €

PARTE ESTERNA LOOP

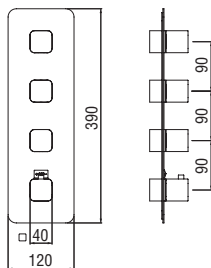

**Parte esterna termostatico a 3 vie**

- Blocco di sicurezza 38° C
- Montaggio verticale o orizzontale

Cromo lucido LP90103CR 826,00 €

  
NR00008  
34,00 €

PARTE ESTERNA SEVEN - RAY - MIA

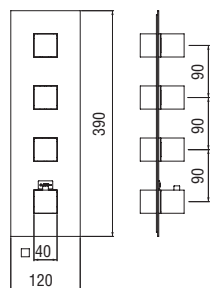

**Parte esterna termostatico a 3 vie**

- Blocco di sicurezza 38° C
- Montaggio verticale o orizzontale

Cromo lucido WE00103/QCR 965,00 €

Inox spazzolato WE00103/QIX 1.447,00 €

Mora opaco WE00103/QBM 1.447,00 €

  
NR00008  
34,00 €

PARTE ESTERNA SOFÌ

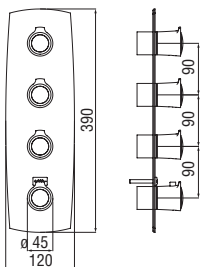

Parte esterna termostatico a 3 vie

- Blocco di sicurezza 38° C
- Montaggio verticale o orizzontale

Cromo lucido	SI98103CR	845,00 €
Caffè spazzolato	SI98103SB	<b>NEW</b> 1.352,00 €



NR00008  
34,00 €

PARTE ESTERNA LIRA

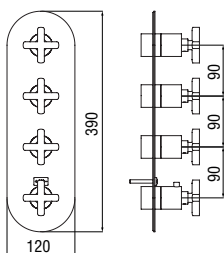

Parte esterna termostatico a 3 vie

- Blocco di sicurezza 38° C
- Montaggio verticale o orizzontale

Cromo lucido	LR116103CR	868,00 €
Grafite spazzolato PVD	LR116103GUP	<b>NEW</b> 1.389,00 €
Mora opaco	LR116103BM	1.303,00 €



NR00008  
34,00 €

PARTE ESTERNA CARLOS PRIMERO

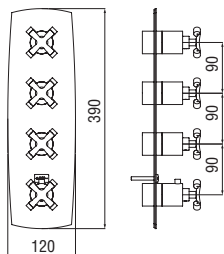

Parte esterna termostatico a 3 vie

- Blocco di sicurezza 38° C
- Montaggio verticale o orizzontale

Cromo lucido	CP103CR	884,00 €
Miele spazzolato PVD	CP103CGP	<b>NEW</b> 1.414,00 €
Caffè spazzolato	CP103SB	<b>NEW</b> 1.414,00 €



NR00008  
34,00 €

PARTE ESTERNA GRAZIA

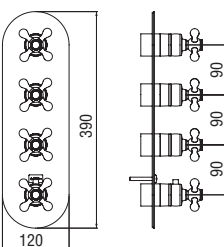

Parte esterna termostatico a 3 vie

- Blocco di sicurezza 38° C
- Montaggio verticale o orizzontale

Cromo lucido	GRC5103CR	884,00 €
Miele spazzolato PVD	GRC5103CGP	<b>NEW</b> 1.414,00 €



NR00008  
34,00 €

WELLBOX

# DOCCIA TERMOSTATICO 4 VIE

Centro Stile Nobili

Wellbox 4 vie amplifica il benessere nello spazio doccia, abbinando il soffione a 2 getti al set doccia (o asta murale) e ai bodyjet. La tecnologia termostatica Nobili assicura il massimo comfort d'utilizzo, mentre la possibilità di montaggio su cartongesso (sia verticale che orizzontale) così come il collegamento delle tubature a sinistra o destra, rendono estremamente versatile questa soluzione.



PARTE INCASSO

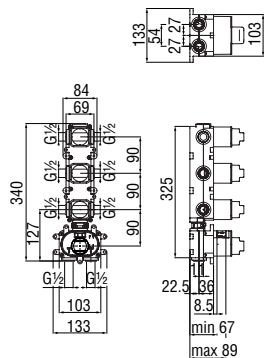

Parte incasso necessaria a 4 vie

- Ingresso e uscita acqua  $\varnothing$  1/2"
- Rubinetti di chiusura
- Valvole antiritorno
- Adatta anche a montaggio su cartongesso
- Filtri di ricambio cartuccia inclusi nella confezione

- WE00104 360,00 €



RCR201/5  
58,00 €



RCR201/28  
39,00 €



RVT200/5D  
18,00 €

PARTE ESTERNA SOLE

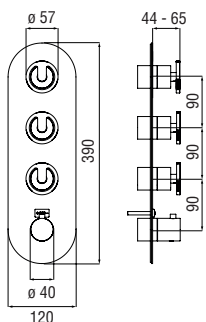

Parte esterna termostatico a 3-4 vie

- Blocco di sicurezza 38° C
- Montaggio verticale o orizzontale

Inox spazzolato	SOI30103IX	NEW	1.428,00 €
Grafite spazzolato PVD	SOI30103GUP	NEW	1.523,00 €
Caffè spazzolato	SOI30103SB	NEW	1.523,00 €
Argilla spazzolato PVD	SOI30103RTP	NEW	1.523,00 €
Cromo lucido	SOI30103CR	NEW	952,00 €



NR00008  
34,00 €

PARTE ESTERNA VELIS - LIVE

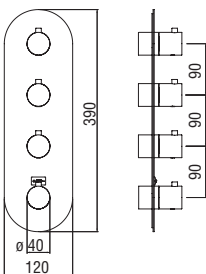

Parte esterna termostatico a 4 vie

- Blocco di sicurezza 38° C
- Montaggio verticale o orizzontale

Cromo lucido	WE00104/TCR	856,00 €
Inox spazzolato	WE00104/TIX	1.283,00 €
Grafite spazzolato PVD	WE00104/TGUP	1.368,00 €
Mora opaco	WE00104/TBM	1.283,00 €
Neve opaco	WE00104/TWM	1.283,00 €
Miele spazzolato PVD	WE00104/TCGP	NEW 1.368,00 €
Caffè spazzolato	WE00104/TSB	NEW 1.368,00 €
Tramonto lucido PVD	WE00104/TRCP	1.368,00 €
Argilla spazzolato PVD	WE00104/TRTP	1.368,00 €



NR00008  
34,00 €

PARTE ESTERNA DRESS

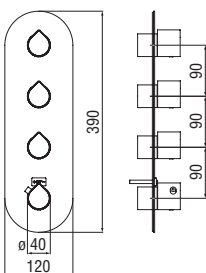

Parte esterna termostatico a 4 vie

- Blocco di sicurezza 38° C
- Montaggio verticale o orizzontale

Cromo and Colour	DS106104C--	993,00 €
Cromo and Wood	DS106104C--	1.240,00 €
Inox T.E.A.+ and Fenix	DS106104T--	1.490,00 €
Cromo and Matter	DS106104C--	1.490,00 €
Cromo and Carbon	DS106104C--	2.171,00 €
Inox T.E.A.+ and Carbon	DS106104T--	2.171,00 €
Cromo and Guilloché	DS106104C--	2.652,00 €



NR00008  
34,00 €

PARTE ESTERNA LIKID

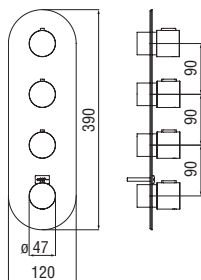

**Parte esterna termostatico a 4 vie**

- Blocco di sicurezza 38° C
- Montaggio verticale o orizzontale

Cromo lucido LK00104CR 845,00 €

 NR00008  
34,00 €

PARTE ESTERNA YOYO - UP

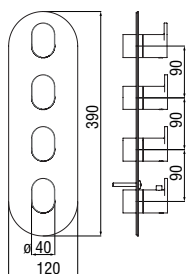

**Parte esterna termostatico a 4 vie**

- Blocco di sicurezza 38° C
- Montaggio verticale o orizzontale

Cromo lucido UP94104CR 783,00 €

Mora opaco UP94104BM 1.174,00 €

 NR00008  
34,00 €

PARTE ESTERNA LOOP

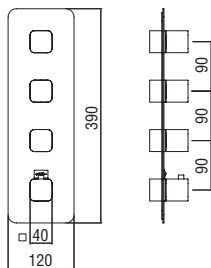

**Parte esterna termostatico a 4 vie**

- Blocco di sicurezza 38° C
- Montaggio verticale o orizzontale

Cromo lucido LP90104CR 826,00 €

 NR00008  
34,00 €

PARTE ESTERNA SEVEN - RAY - MIA

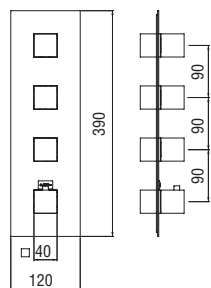

**Parte esterna termostatico a 4 vie**

- Blocco di sicurezza 38° C
- Montaggio verticale o orizzontale

Cromo lucido WE00104/QCR 965,00 €

Inox spazzolato WE00104/QIX 1.447,00 €

Mora opaco WE00104/QBM 1.447,00 €

 NR00008  
34,00 €

PARTE ESTERNA SOFÌ

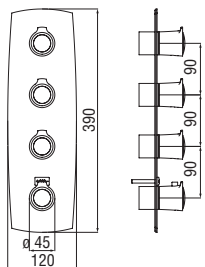

Parte esterna termostatico a 4 vie

- Blocco di sicurezza 38° C
- Montaggio verticale o orizzontale

Cromo lucido	SI98104CR	845,00 €
Caffè spazzolato	SI98104SB	<b>NEW</b> 1.352,00 €



NR00008  
34,00 €

PARTE ESTERNA LIRA

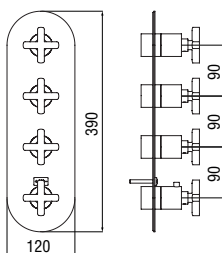

Parte esterna termostatico a 4 vie

- Blocco di sicurezza 38° C
- Montaggio verticale o orizzontale

Cromo lucido	LR116104CR	868,00 €
Grafite spazzolato PVD	LR116104GUP	<b>NEW</b> 1.389,00 €
Mora opaco	LR116104BM	1.303,00 €



NR00008  
34,00 €

PARTE ESTERNA CARLOS PRIMERO

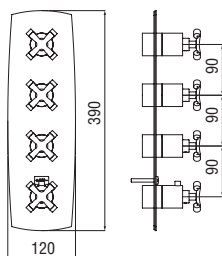

Parte esterna termostatico a 4 vie

- Blocco di sicurezza 38° C
- Montaggio verticale o orizzontale

Cromo lucido	CP104CR	884,00 €
Miele spazzolato PVD	CP104CGP	<b>NEW</b> 1.414,00 €
Caffè spazzolato	CP104SB	<b>NEW</b> 1.414,00 €



NR00008  
34,00 €

PARTE ESTERNA GRAZIA

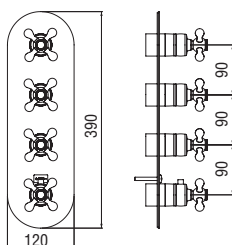

Parte esterna termostatico a 4 vie

- Blocco di sicurezza 38° C
- Montaggio verticale o orizzontale

Cromo lucido	GRC5104CR	884,00 €
Miele spazzolato PVD	GRC5104CGP	<b>NEW</b> 1.414,00 €



NR00008  
34,00 €



ONOFF

# DOCCIA TERMOSTATICO 2 VIE

Centro Stile Nobili

Onoff permette di creare un impianto a due vie con miscelazione termostatica, combinando stile minimale e avanguardia tecnologica: l'attivazione tramite valvole on / off e la regolazione della portata sulle singole vie aumentano il comfort ed enfatizzano il piacere della doccia nella tranquillità della propria sala da bagno.



PARTE INCASSO

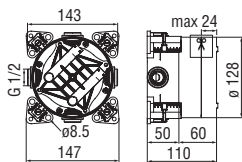

**Parte incasso necessaria**

- Ingresso acqua calda e acqua fredda ø 1/2"
- Uscite ø 1/2"
- Valvole antiritorno
- Adatta anche a montaggio su cartongesso

- WE00202 110,00 €

 RCR201/40  
132,00 €

 RVT200/40  
139,00 €

PARTE ESTERNA

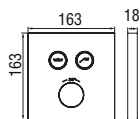

**Parte esterna termostatico a 2 vie**

- Blocco di sicurezza 38° C
- Regolazione di portata sulle singole vie

Cromo lucido WE00202/ECR 712,00 €

**Parte esterna termostatico a 2 vie**

- Blocco di sicurezza 38° C
- Regolazione di portata sulle singole vie

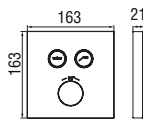

Cromo l. e vetro bianco WE00202/EWCR 835,00 €  
Cromo l. e vetro nero WE00202/EBCR 835,00 €

## DOCCIA

La nostra gamma di termostatici esterni, differenti per stile e funzionalità, tutti i componenti doccia, le colonne (suddivise tra miscelazione termostatica o monocomando, oltre alle versioni dedicate alla ristrutturazione) e i set completi, nati con l'obiettivo di semplificare e velocizzare la scelta nel vasto universo di proposte.





## COMPONENTI DOCCIA

SOFFIONI	339
BRACCI	349
BODYJET	354
SET DOCCIA	356
ASTE MURALI	360
DOCCETTE	365
PRESE ACQUA	369
SUPPORTI	371
FLESSIBILI	375

## TERMOSTATICI ESTERNI

DOCCIA	377
VASCA - DOCCIA	381

## COLONNE DOCCIA

TERMOSTATICHE	389
MONOCOMANDO	401
RENOVA	411

## SET DOCCIA COMPLETI

INCASSO	417
ESTERNI	422

DOCCIA

# COMPONENTI DOCCIA

Centro Stile Nobili

La forma più elevata di benessere incontra soluzioni aperte a qualsiasi esigenza: l'ampia varietà di scelta estetica e funzionale permette di dare vita ad infinite soluzioni di impianti doccia, scegliendo con semplicità tra la totalità di articoli dedicati e assecondando i singoli gusti e le intime preferenze.



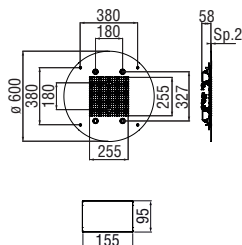
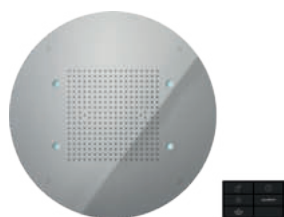

**Soffione a incasso con cromoterapia (Inox)**

- Dimensione ø 600 mm
- Ingresso a 2 vie
- Getto pioggia
- Getto nebulizzato
- Luce a 4 LED
- Trasformatore e tastiera di comando inclusi

Cromo lucido AD139/91CR 3.919,00 €

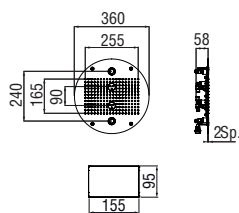

**Soffione a incasso con cromoterapia (Inox)**

- Dimensione ø 360 mm
- Ingresso a 2 vie
- Getto pioggia
- Getto nebulizzato
- Luce a 2 LED
- Trasformatore e tastiera di comando inclusi

Cromo lucido AD139/90CR 2.800,00 €

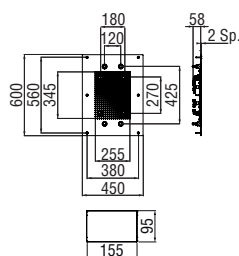

**Soffione a incasso con cromoterapia (Inox)**

- Dimensione 600 x 450 mm
- Ingresso a 2 vie
- Getto pioggia
- Getto nebulizzato
- Luce a 4 LED
- Trasformatore e tastiera di comando inclusi

Cromo lucido AD139/93CR 4.038,00 €

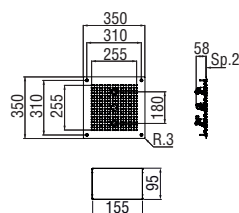
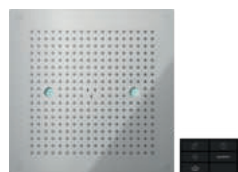

**Soffione a incasso con cromoterapia (Inox)**

- Dimensione 350 x 350 mm
- Ingresso a 2 vie
- Getto pioggia
- Getto nebulizzato
- Luce a 2 LED
- Trasformatore e tastiera di comando inclusi

Cromo lucido AD139/92CR 3.513,00 €

**Soffione a incasso (Inox)**

- Dimensione ø 500 mm
- Getto pioggia

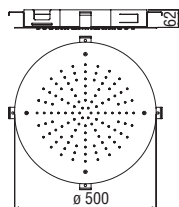

Cromo lucido	AD139/105CR	1.089,00 €
--------------	-------------	------------

**Soffione a incasso (Inox)**

- Dimensione ø 380 mm
- Getto pioggia

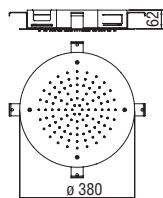

Cromo lucido	AD139/104CR	842,00 €
Inox spazzolato	AD139/104IX	<b>NEW</b> 1.316,00 €
Grafite spazzolato PVD	AD139/104GUP	<b>NEW</b> 1.347,00 €
Mora opaco	AD139/104BM	<b>NEW</b> 1.316,00 €
Neve opaco	AD139/104WM	<b>NEW</b> 1.316,00 €
Miele spazzolato PVD	AD139/104CGP	<b>NEW</b> 1.347,00 €
Caffè spazzolato	AD139/104SB	<b>NEW</b> 1.347,00 €
Tramonto lucido PVD	AD139/104RCP	<b>NEW</b> 1.347,00 €
Argilla spazzolato PVD	AD139/104RTP	<b>NEW</b> 1.347,00 €

**Soffione a incasso (Inox)**

- Dimensione 420 x 420 mm
- Getto pioggia

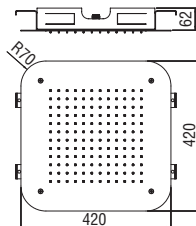

Cromo lucido	AD139/103CR	1.347,00 €
--------------	-------------	------------

**Soffione a incasso a 2 vie (Inox)**

- Dimensione 500 x 500 mm
- Getto pioggia, getto cascata

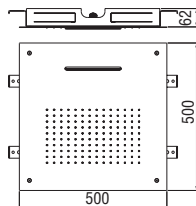

Cromo lucido	AD139/102CR	1.208,00 €
Inox spazzolato	AD139/102IX	1.811,00 €
Grafite spazzolato PVD	AD139/102GUP	2.174,00 €
Mora opaco	AD139/102BM	1.811,00 €
Miele spazzolato PVD	AD139/102CGP	<b>NEW</b> 2.174,00 €
Caffè spazzolato	AD139/102SB	<b>NEW</b> 2.174,00 €
Tramonto lucido PVD	AD139/102RCP	2.174,00 €
Argilla spazzolato PVD	AD139/102RTP	2.174,00 €



**Soffione a incasso (Inox)**

- Dimensione 500 x 500 mm
- Getto pioggia

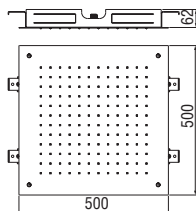
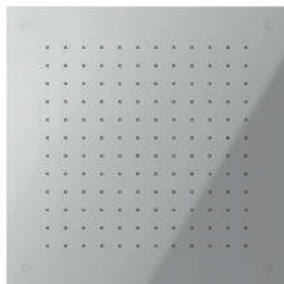

Cromo lucido	AD139/101CR	1.071,00 €
Mora opaco	AD139/101BM	1.563,00 €

**Soffione a incasso (Inox)**

- Dimensione 380 x 380 mm
- Getto pioggia

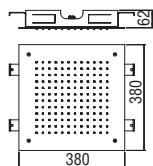

Cromo lucido	AD139/100CR	842,00 €
Inox spazzolato	AD139/100IX	<b>NEW</b> 1.316,00 €
Grafite spazzolato PVD	AD139/100GUP	<b>NEW</b> 1.347,00 €
Mora opaco	AD139/100BM	1.316,00 €
Neve opaco	AD139/100WM	<b>NEW</b> 1.316,00 €
Miele spazzolato PVD	AD139/100CGP	<b>NEW</b> 1.347,00 €
Caffè spazzolato	AD139/100SB	<b>NEW</b> 1.347,00 €
Tramonto lucido PVD	AD139/100RCP	<b>NEW</b> 1.347,00 €
Argilla spazzolato PVD	AD139/100RTP	<b>NEW</b> 1.347,00 €

**Soffione a incasso (Abs)**

- Dimensione 220 x 220 mm
- Getto pioggia
- Sistema anticalcare

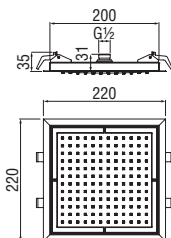

Cromo lucido	AD139/34CCR	558,00 €
--------------	-------------	----------

**Soffione a parete a 2 vie (Inox)**

- Dimensione 593 x 270 mm
- Getto pioggia, getto cascata

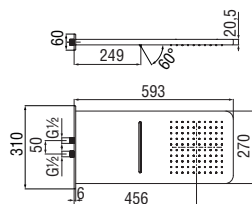

Cromo lucido	AD139/130CR	1.066,00 €
Inox spazzolato	AD139/130IX	<b>NEW</b> 1.599,00 €
Mora opaco	AD139/130BM	<b>NEW</b> 1.599,00 €
Neve opaco	AD139/130WM	<b>NEW</b> 1.599,00 €
Caffè spazzolato	AD139/130SB	<b>NEW</b> 1.706,00 €



**Soffione a parete a 2 vie (Inox)**

- Dimensione 593 x 270 mm
- Getto pioggia, getto cascata

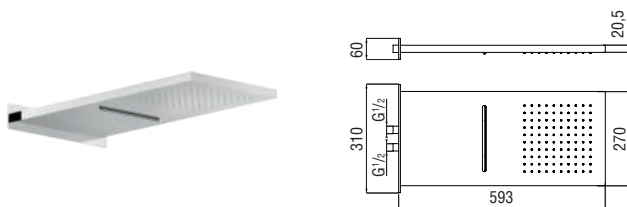

Cromo lucido	AD139/139CR	NEW	993,00 €
Inox spazzolato	AD139/139IX	NEW	1.490,00 €
Mora opaco	AD139/139BM	NEW	1.490,00 €
Neve opaco	AD139/139WM	NEW	1.490,00 €
Caffè spazzolato	AD139/139SB	NEW	1.589,00 €

**Bocca a parete (Inox)**

- Getto cascata



Cromo lucido	AV00156/9CR		525,00 €
Inox spazzolato	AV00156/9IX	NEW	787,00 €
Grafite spazzolato PVD	AV00156/9GUP	NEW	840,00 €
Mora opaco	AV00156/9BM	NEW	787,00 €
Neve opaco	AV00156/9WM	NEW	787,00 €
Miele spazzolato PVD	AV00156/9CGP	NEW	840,00 €
Caffè spazzolato	AV00156/9SB	NEW	840,00 €
Tramonto lucido PVD	AV00156/9RCP	NEW	840,00 €
Argilla spazzolato PVD	AV00156/9RTP	NEW	840,00 €

**Bocca a parete (Inox)**

- Getto cascata

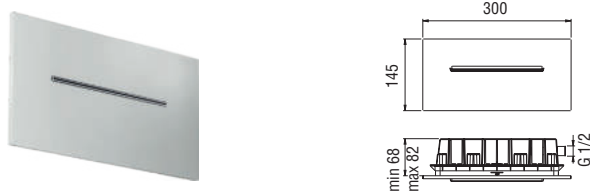

Cromo lucido	AV00156/10CR		525,00 €
Inox spazzolato	AV00156/10IX	NEW	787,00 €
Grafite spazzolato PVD	AV00156/10GUP	NEW	840,00 €
Mora opaco	AV00156/10BM	NEW	787,00 €
Neve opaco	AV00156/10WM	NEW	787,00 €
Miele spazzolato PVD	AV00156/10CGP	NEW	840,00 €
Caffè spazzolato	AV00156/10SB	NEW	840,00 €
Tramonto lucido PVD	AV00156/10RCP	NEW	840,00 €
Argilla spazzolato PVD	AV00156/10RTP	NEW	840,00 €

**Soffione a parete (Ottone)**

- Getto pioggia

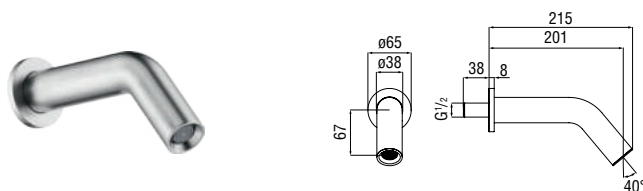

Inox spazzolato	AD139/137IX	NEW	321,00 €
Grafite spazzolato PVD	AD139/137GUP	NEW	342,00 €
Caffè spazzolato	AD139/137SB	NEW	342,00 €
Argilla spazzolato PVD	AD139/137RTP	NEW	342,00 €
Cromo lucido	AD139/137CR	NEW	214,00 €

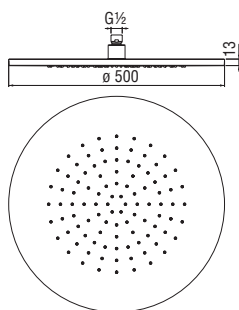
**Soffione a snodo (Inox)**

- Dimensione  $\varnothing$  500 mm
- Getto pioggia

Cromo lucido                      AD139/115CR                      820,00 €

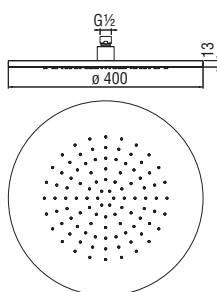
**Soffione a snodo (Inox)**

- Dimensione  $\varnothing$  400 mm
- Getto pioggia

Cromo lucido                      AD139/114CR                      629,00 €

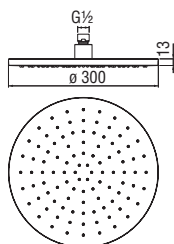
**Soffione a snodo (Inox)**

- Dimensione  $\varnothing$  300 mm
- Getto pioggia

Cromo lucido                      AD139/113CR                      415,00 €

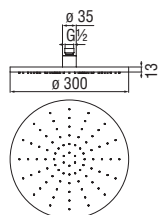
**Soffione a snodo (Abs)**

- Dimensione  $\varnothing$  300 mm
- Getto pioggia

Cromo lucido	AD139/63CR	314,00 €
Inox spazzolato	AD139/63IX	471,00 €
Grafite spazzolato PVD	AD139/63GUP	566,00 €
Mora opaco	AD139/63BM	471,00 €
Neve opaco	AD139/63WM	471,00 €
Miele spazzolato PVD	AD139/63CGP	<b>NEW</b> 566,00 €
Caffè spazzolato	AD139/63SB	<b>NEW</b> 566,00 €
Tramonto lucido PVD	AD139/63RCP	566,00 €
Argilla spazzolato PVD	AD139/63RTP	566,00 €

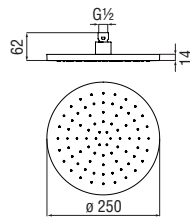

**Soffione a snodo (Abs)**

- Dimensione  $\varnothing$  250 mm
- Getto pioggia

Cromo lucido	AD139/142CR	NEW	169,00 €
Inox spazzolato	AD139/142IX	NEW	254,00 €
Grafite spazzolato PVD	AD139/142GUP	NEW	286,00 €
Mora opaco	AD139/142BM	NEW	254,00 €
Neve opaco	AD139/142WM	NEW	254,00 €
Miele spazzolato PVD	AD139/142CGP	NEW	286,00 €
Caffè spazzolato	AD139/142SB	NEW	286,00 €
Tramonto lucido PVD	AD139/142RCP	NEW	286,00 €
Argilla spazzolato PVD	AD139/142RTP	NEW	286,00 €

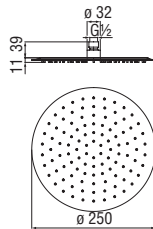

**Soffione a snodo (Inox)**

- Spessore 2 mm
- Dimensione  $\varnothing$  250 mm
- Getto pioggia
- Sistema anticalcare

Cromo lucido	AD139/121CR	132,00 €
Mora opaco	AD139/121BM	198,00 €

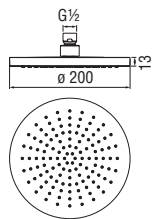

**Soffione a snodo (Ottone)**

- Dimensione  $\varnothing$  200 mm
- Getto pioggia

Cromo lucido	AD139/112CR	152,00 €
Inox spazzolato	AD139/112IX	228,00 €
Grafite spazzolato PVD	AD139/112GUP	274,00 €
Mora opaco	AD139/112BM	228,00 €
Neve opaco	AD139/112WM	228,00 €
Miele spazzolato PVD	AD139/112CGP	NEW 274,00 €
Caffè spazzolato	AD139/112SB	NEW 274,00 €
Tramonto lucido PVD	AD139/112RCP	274,00 €
Argilla spazzolato PVD	AD139/112RTP	274,00 €

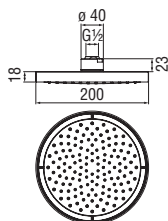

**Soffione a snodo (Abs)**

- Dimensione  $\varnothing$  200 mm
- Getto pioggia

Cromo lucido	AD139/10CCR	218,00 €
Inox spazzolato	AD139/10CIX	243,00 €
Grafite spazzolato PVD	AD139/10CGUP	254,00 €
Mora opaco	AD139/10CBM	243,00 €
Neve opaco	AD139/10CWM	243,00 €
Miele spazzolato PVD	AD139/10CCGP	NEW 254,00 €
Caffè spazzolato	AD139/10CSB	NEW 254,00 €
Tramonto lucido PVD	AD139/10CRCP	254,00 €
Argilla spazzolato PVD	AD139/10CRTP	254,00 €

**Soffione a snodo (Abs)**

- Dimensione ø 200 mm
- Getto pioggia

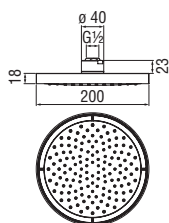

Cromo l. e grigio AD139/10CR 149,00 €

**Soffione a snodo (Abs)**

- Dimensione ø 200 mm
- Getto pioggia
- Portata 9 l/min

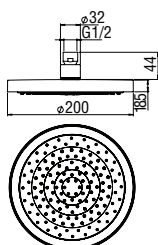

Cromo l. e grigio WE00139/94CR 99,00 €

**Soffione a snodo (Abs)**

- Dimensione ø 130 mm
- Getto seta, portata 7 l/min

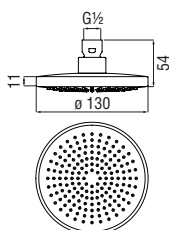

Cromo lucido	AD139/140CR	<b>NEW</b>	130,00 €
Inox spazzolato	AD139/140IX	<b>NEW</b>	195,00 €
Grafite spazzolato PVD	AD139/140GUP	<b>NEW</b>	208,00 €
Mora opaco	AD139/140BM	<b>NEW</b>	195,00 €
Neve opaco	AD139/140WM	<b>NEW</b>	195,00 €
Miele spazzolato PVD	AD139/140CGP	<b>NEW</b>	208,00 €
Caffè spazzolato	AD139/140SB	<b>NEW</b>	208,00 €
Tramonto lucido PVD	AD139/140RCP	<b>NEW</b>	208,00 €
Argilla spazzolato PVD	AD139/140RTP	<b>NEW</b>	208,00 €

**Soffione a snodo (Abs)**

- Dimensione ø 100 mm
- Getto seta, portata 6 l/min

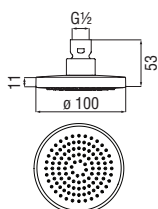

Cromo lucido	AD139/141CR	<b>NEW</b>	108,00 €
Inox spazzolato	AD139/141IX	<b>NEW</b>	162,00 €
Grafite spazzolato PVD	AD139/141GUP	<b>NEW</b>	175,00 €
Mora opaco	AD139/141BM	<b>NEW</b>	162,00 €
Neve opaco	AD139/141WM	<b>NEW</b>	162,00 €
Miele spazzolato PVD	AD139/141CGP	<b>NEW</b>	175,00 €
Caffè spazzolato	AD139/141SB	<b>NEW</b>	175,00 €
Tramonto lucido PVD	AD139/141RCP	<b>NEW</b>	175,00 €
Argilla spazzolato PVD	AD139/141RTP	<b>NEW</b>	175,00 €

**Soffione a snodo (Inox)**

- Dimensione  $\varnothing$  290 mm
- Getto pioggia

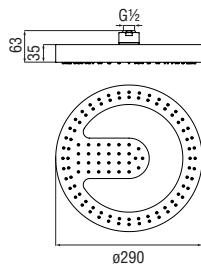

Inox spazzolato	AD139/138IX	NEW	1.950,00 €
Grafite spazzolato PVD	AD139/138GUP	NEW	2.080,00 €
Caffè spazzolato	AD139/138SB	NEW	2.080,00 €
Argilla spazzolato PVD	AD139/138RTP	NEW	2.080,00 €
Cromo lucido	AD139/138CR	NEW	1.300,00 €

**Soffione a snodo (Abs)**

- Dimensione 300 x 300 mm
- Getto pioggia

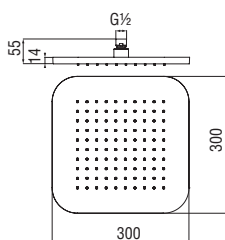

Cromo lucido	AD139/129CR		324,00 €
--------------	-------------	--	----------

**Soffione a snodo (Abs)**

- Dimensione 220 x 220 mm
- Getto pioggia

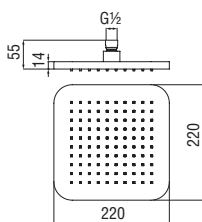

Cromo lucido	AD139/79CR		221,00 €
--------------	------------	--	----------

**Soffione a snodo (Abs)**

- Dimensione 245 x 245 mm
- Getto pioggia

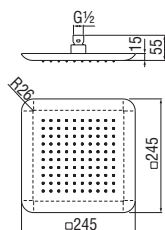

Cromo lucido	AD139/122CR		205,00 €
Inox spazzolato	AD139/122IX	NEW	308,00 €
Mora opaco	AD139/122BM		308,00 €

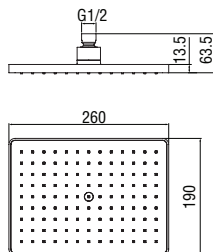

**Soffione a snodo (Abs)**

- Dimensione 260 x 190 mm
- Getto pioggia

Cromo lucido AD139/132CR 260,00 €

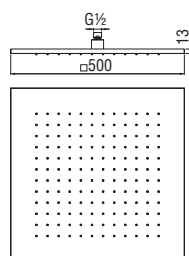

**Soffione a snodo (Inox)**

- Dimensione 500 x 500 mm
- Getto pioggia

Cromo lucido AD139/111CR 842,00 €

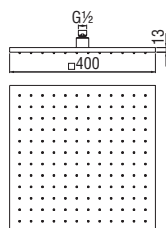

**Soffione a snodo (Inox)**

- Dimensione 400 x 400 mm
- Getto pioggia

Cromo lucido AD139/110CR 660,00 €

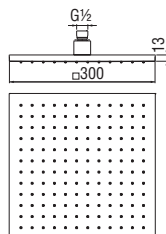

**Soffione a snodo (Inox)**

- Dimensione 300 x 300 mm
- Getto pioggia

Cromo lucido AD139/109CR 433,00 €

**Soffione a snodo (Abs)**

- Dimensione 300 x 300 mm
- Getto pioggia

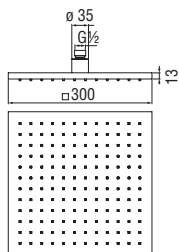

Cromo lucido	AD139/64CR	278,00 €
Inox spazzolato	AD139/64IX	417,00 €
Mora opaco	AD139/64BM	417,00 €

**Soffione a snodo (Inox)**

- Spessore 2 mm
- Dimensione 250 x 250 mm
- Getto pioggia
- Sistema anticalcare

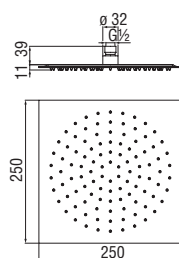

Cromo lucido	AD139/134CR	164,00 €
--------------	-------------	----------

**Soffione a snodo (Ottone)**

- Dimensione 200 x 200 mm
- Getto pioggia

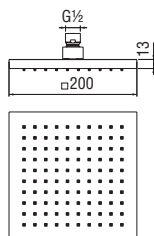

Cromo lucido	AD139/108CR	227,00 €
--------------	-------------	----------

**Soffione a snodo (Abs)**

- Dimensione 200 x 200 mm
- Getto pioggia

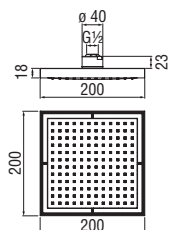

Cromo lucido	AD139/17CCR	259,00 €
Inox spazzolato	AD139/17CIX	287,00 €
Mora opaco	AD139/17CBM	287,00 €

**Soffione a snodo (Abs)**

- Dimensione 200 x 200 mm
- Getto pioggia

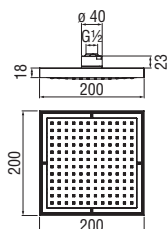

Cromo l. e grigio AD139/17CR 188,00 €

**Soffione a snodo (Ottone)**

- Dimensione ø 200 mm
- Getto pioggia

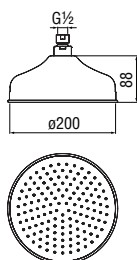

Cromo lucido	AD139/12CR		242,00 €
Miele spazzolato PVD	AD139/12CGP	<b>NEW</b>	387,00 €
Caffè spazzolato	AD139/12SB	<b>NEW</b>	387,00 €

**Braccio a parete**

- Lunghezza 500 mm
- Fisher di supporto

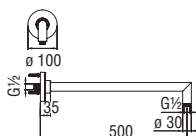

Cromo lucido AD138/59CR 205,00 €

**Braccio a parete**

- Lunghezza 350 mm

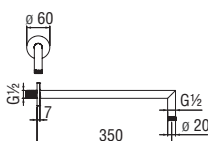

Cromo lucido	AD138/44CR		90,00 €
Inox spazzolato	AD138/44IX		135,00 €
Grafite spazzolato PVD	AD138/44GUP		146,00 €
Mora opaco	AD138/44BM		135,00 €
Neve opaco	AD138/44WM		135,00 €
Miele spazzolato PVD	AD138/44CGP	<b>NEW</b>	146,00 €
Caffè spazzolato	AD138/44SB	<b>NEW</b>	146,00 €
Tramonto lucido PVD	AD138/44RCP		146,00 €
Argilla spazzolato PVD	AD138/44RTP		146,00 €



**Braccio a parete**

· Lunghezza 400 mm

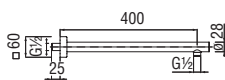

Cromo lucido

AD138/42CR

148,00 €

**Braccio a parete**

· Lunghezza 300 mm

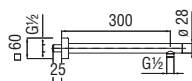

Cromo lucido

AD138/43CR

131,00 €

**Braccio a parete**

· Lunghezza 500 mm

· Fisher di supporto

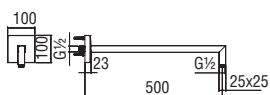

Cromo lucido

AD138/54CR

228,00 €

**Braccio a parete**

· Lunghezza 350 mm

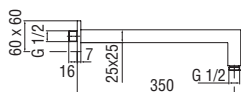

Cromo lucido

AD138/24CR

122,00 €

Inox spazzolato

AD138/24IX

182,00 €

Mora opaco

AD138/24BM

182,00 €

**Braccio a parete**

· Lunghezza 350 mm

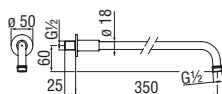

Cromo lucido	AD138/4CR		82,00 €
Miele spazzolato PVD	AD138/4CGP	NEW	131,00 €
Caffè spazzolato	AD138/4SB	NEW	131,00 €

**Braccio a parete**

· Lunghezza 280 mm

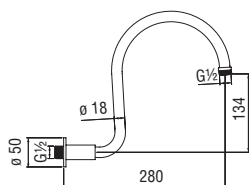

Cromo lucido	AD138/60CR		164,00 €
Miele spazzolato PVD	AD138/60CGP	NEW	262,00 €
Caffè spazzolato	AD138/60SB	NEW	262,00 €

**Braccio a parete**

· Lunghezza 140 mm

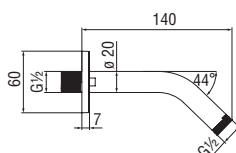

Cromo lucido	AD138/40CR		51,00 €
Inox spazzolato	AD138/40IX	NEW	76,00 €
Grafite spazzolato PVD	AD138/40GUP	NEW	82,00 €
Mora opaco	AD138/40BM	NEW	76,00 €
Neve opaco	AD138/40WM	NEW	76,00 €
Miele spazzolato PVD	AD138/40CGP	NEW	82,00 €
Caffè spazzolato	AD138/40SB	NEW	82,00 €
Tramonto lucido PVD	AD138/40RCP	NEW	82,00 €
Argilla spazzolato PVD	AD138/40RTP	NEW	82,00 €

**Braccio a soffitto**

· Lunghezza 300 mm

· Fisher di supporto

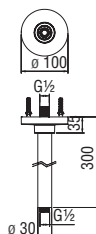

Cromo lucido	AD138/56CR		255,00 €
--------------	------------	--	----------

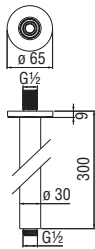
**Braccio a soffitto**

· Lunghezza 300 mm

Cromo lucido	AD138/64CR	149,00 €
Inox spazzolato	AD138/64IX	223,00 €
Grafite spazzolato PVD	AD138/64GUP	238,00 €
Mora opaco	AD138/64BM	223,00 €
Neve opaco	AD138/64WM	223,00 €
Miele spazzolato PVD	AD138/64CGP	<b>NEW</b> 238,00 €
Caffè spazzolato	AD138/64SB	<b>NEW</b> 238,00 €
Tramonto lucido PVD	AD138/64RCP	238,00 €
Argilla spazzolato PVD	AD138/64RTP	238,00 €

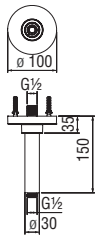
**Braccio a soffitto**

· Lunghezza 150 mm

· Fisher di supporto

Cromo lucido	AD138/55CR	213,00 €
--------------	------------	----------

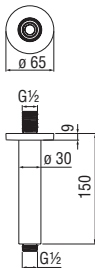
**Braccio a soffitto**

· Lunghezza 150 mm

Cromo lucido	AD138/63CR	152,00 €
--------------	------------	----------

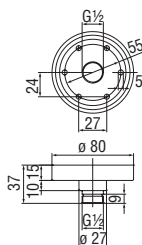
**Supporto a soffitto**

· Lunghezza 25 mm

Cromo lucido	AD138/20CR	158,00 €
--------------	------------	----------

**Braccio a soffitto**

· Lunghezza 300 mm

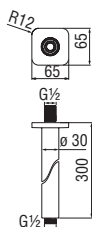

Cromo lucido AD138/62CR 180,00 €

**Braccio a soffitto**

· Lunghezza 150 mm

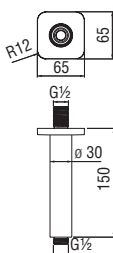

Cromo lucido AD138/61CR 152,00 €

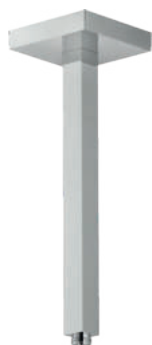
**Braccio a soffitto**

· Lunghezza 300 mm

· Fisher di supporto

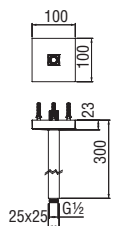

Cromo lucido AD138/51CR 291,00 €

**Braccio a soffitto**

· Lunghezza 300 mm

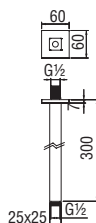

Cromo lucido	AD138/66CR	180,00 €
Inox spazzolato	AD138/66IX	269,00 €
Mora opaco	AD138/66BM	269,00 €

**Braccio a soffitto**

- Lunghezza 150 mm
- Fisher di supporto

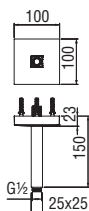

Cromo lucido AD138/50CR 264,00 €

**Braccio a soffitto**

- Lunghezza 150 mm

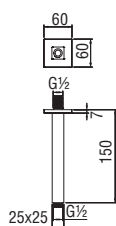

Cromo lucido AD138/65CR 152,00 €

## BODYJET

**Bodyjet esterno**

- Getto pioggia orientabile

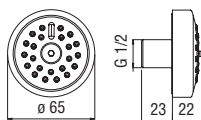

Cromo lucido	WE00139/81CR	158,00 €
Inox spazzolato	WE00139/81IX	236,00 €
Grafite spazzolato PVD	WE00139/81GUP	251,00 €
Mora opaco	WE00139/81BM	236,00 €
Neve opaco	WE00139/81WM	236,00 €
Miele spazzolato PVD	WE00139/81CGP	<b>NEW</b> 251,00 €
Caffè spazzolato	WE00139/81SB	<b>NEW</b> 251,00 €
Tramonto lucido PVD	WE00139/81RCP	251,00 €
Argilla spazzolato PVD	WE00139/81RTP	251,00 €

**Bodyjet a incasso**

- Getto pioggia orientabile

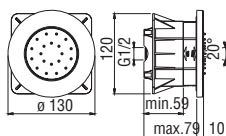

Cromo lucido WE00139/87CR 141,00 €

**Bodyjet esterno**

· Getto pioggia orientabile

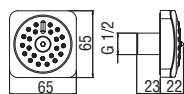

Cromo lucido WE00139/80CR 158,00 €

**Bodyjet a incasso**

· Getto pioggia orientabile

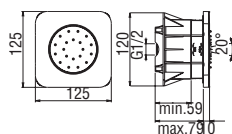

Cromo lucido WE00139/86CR 141,00 €

**Bodyjet esterno**

· Getto pioggia orientabile

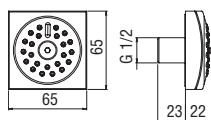

Cromo lucido	WE00139/82CR	158,00 €
Inox spazzolato	WE00139/82IX	236,00 €
Mora opaco	WE00139/82BM	236,00 €

**Bodyjet a incasso**

· Getto pioggia orientabile

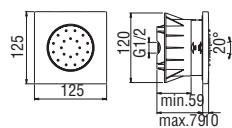

Cromo lucido WE00139/85CR 144,00 €

**Bodyjet a incasso**

· A 3 getti orientabili

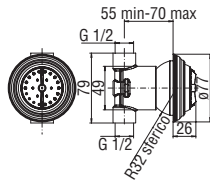

Cromo lucido	WE00139/24CR		207,00 €
Miele spazzolato PVD	WE00139/24CGP	NEW	331,00 €
Caffè spazzolato	WE00139/24SB	NEW	331,00 €



NR00005  
118,00 €

**SET DOCCIA**

**Set doccia con presa acqua ø 1/2"**

· Supporto doccetta fisso rivestito in Teflon  
· Doccetta a 3 getti e flessibile 150 cm

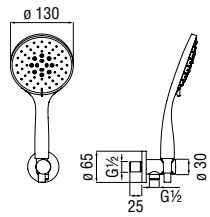

Cromo lucido	AD146/47CR	MOD	170,00 €
Grafite spazzolato PVD	AD146/47GUP	NEW	272,00 €
Mora opaco	AD146/47BM	MOD	257,00 €

**Set doccia con presa acqua ø 1/2"**

· Supporto doccetta fisso rivestito in Teflon  
· Doccetta monogetto e flessibile 150 cm

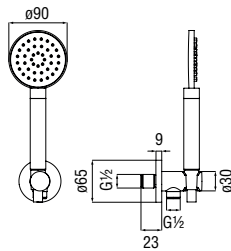

Inox spazzolato	AD146/54IX	NEW	405,00 €
Grafite spazzolato PVD	AD146/54GUP	NEW	432,00 €
Caffè spazzolato	AD146/54SB	NEW	432,00 €
Argilla spazzolato PVD	AD146/54RTP	NEW	432,00 €
Cromo lucido	AD146/54CR	NEW	270,00 €

**Set doccia con presa acqua ø 1/2"**

· Supporto doccetta fisso rivestito in Teflon  
· Doccetta monogetto e flessibile 150 cm

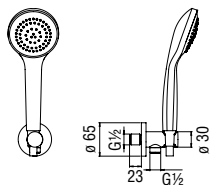

Cromo lucido	AD146/35CR		116,00 €
--------------	------------	--	----------

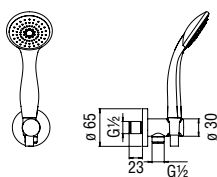

**Set doccia con presa acqua ø 1/2"**

- Supporto doccetta fisso rivestito in Teflon
- Doccetta monogetto e flessibile 150 cm

Cromo lucido	AD146/27CR	86,00 €
--------------	------------	---------

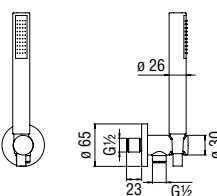

**Set doccia con presa acqua ø 1/2"**

- Supporto doccetta fisso rivestito in Teflon
- Doccetta monogetto e flessibile 150 cm

Cromo lucido	AD146/32CR	116,00 €
Inox spazzolato	AD146/32IX	172,00 €
Grafite spazzolato PVD	AD146/32GUP	184,00 €
Mora opaco	AD146/32BM	172,00 €
Neve opaco	AD146/32WM	172,00 €
Miele spazzolato PVD	AD146/32CGP	184,00 €
Caffè spazzolato	AD146/32SB	184,00 €
Tramonto lucido PVD	AD146/32RCP	184,00 €
Argilla spazzolato PVD	AD146/32RTP	184,00 €

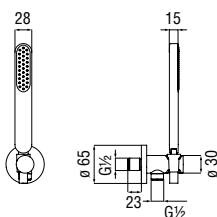

**Set doccia con presa acqua ø 1/2"**

- Supporto doccetta fisso rivestito in Teflon
- Doccetta monogetto e flessibile 150 cm

Cromo lucido	AD146/49CR	<b>MOD</b>	122,00 €
Mora opaco	AD146/49BM	<b>MOD</b>	183,00 €

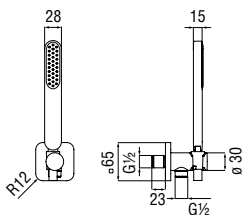

**Set doccia con presa acqua ø 1/2"**

- Supporto doccetta fisso rivestito in Teflon
- Doccetta monogetto e flessibile 150 cm

Cromo lucido	AD146/31CR	<b>MOD</b>	132,00 €
--------------	------------	------------	----------



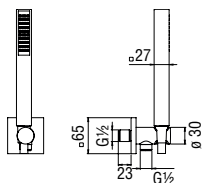

**Set doccia con presa acqua ø 1/2"**

- Supporto doccetta fisso rivestito in Teflon
- Doccetta monogetto e flessibile 150 cm

Cromo lucido	AD146/53CR		144,00 €
Inox spazzolato	AD146/53IX		216,00 €
Mora opaco	AD146/53BM		216,00 €

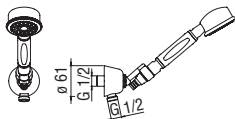

**Set doccia con presa acqua ø 1/2"**

- Supporto doccetta orientabile
- Doccetta monogetto e flessibile 150 cm

Cromo lucido	AD143/7CR		245,00 €
Miele spazzolato PVD	AD143/7CGP	NEW	392,00 €
Caffè spazzolato	AD143/7SB	NEW	392,00 €

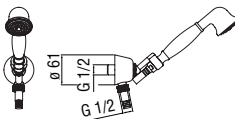

**Set doccia con presa acqua ø 1/2"**

- Supporto doccetta orientabile
- Doccetta monogetto e flessibile 150 cm

Cromo lucido	AD143/6CR		119,00 €
Miele spazzolato PVD	AD143/6CGP	NEW	190,00 €

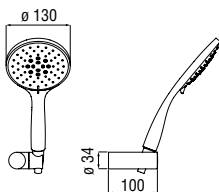

**Set doccia**

- Supporto doccetta orientabile
- Doccetta a 3 getti e flessibile 150 cm

Cromo lucido	AD146/48CR	MOD	142,00 €
Grafite spazzolato PVD	AD146/48GUP	NEW	227,00 €
Mora opaco	AD146/48BM	MOD	213,00 €

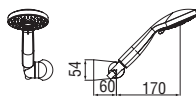

**Set doccia**

- Supporto doccetta orientabile
- Doccetta monogetto e flessibile 150 cm

Cromo lucido AD146/18CR 93,00 €

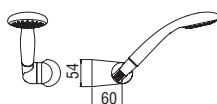

**Set doccia**

- Supporto doccetta orientabile
- Doccetta monogetto e flessibile 150 cm

Cromo lucido AD144/4CR 66,00 €

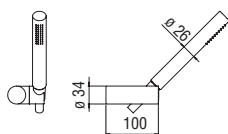

**Set doccia**

- Supporto doccetta orientabile
- Doccetta monogetto e flessibile 150 cm

Cromo lucido	AD146/26CR	89,00 €
Inox spazzolato	AD146/26IX	135,00 €
Grafite spazzolato PVD	AD146/26GUP	144,00 €
Mora opaco	AD146/26BM	135,00 €
Neve opaco	AD146/26WM	135,00 €
Miele spazzolato PVD	AD146/26CGP	<b>NEW</b> 144,00 €
Caffè spazzolato	AD146/26SB	<b>NEW</b> 144,00 €
Tramonto lucido PVD	AD146/26RCP	144,00 €
Argilla spazzolato PVD	AD146/26RTP	144,00 €

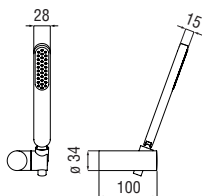

**Set doccia**

- Supporto doccetta orientabile
- Doccetta monogetto e flessibile 150 cm

Cromo lucido	AD146/25CR	<b>MOD</b>	93,00 €
Mora opaco	AD146/25BM	<b>MOD</b>	140,00 €

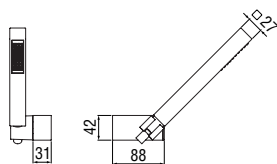

**Set doccia**

- Supporto doccetta orientabile
- Doccetta monogetto e flessibile 150 cm

Cromo lucido	AD146/24CR	113,00 €
Inox spazzolato	AD146/24IX	169,00 €
Mora opaco	AD146/24BM	169,00 €

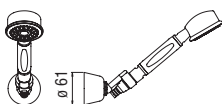

**Set doccia**

- Supporto doccetta orientabile
- Doccetta monogetto e flessibile 150 cm

Cromo lucido	AD144/6CR	217,00 €
Miele spazzolato PVD	AD144/6CGP	<b>NEW</b> 347,00 €
Caffè spazzolato	AD144/6SB	<b>NEW</b> 347,00 €

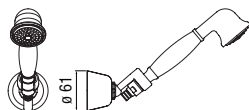

**Set doccia**

- Supporto doccetta orientabile
- Doccetta monogetto e flessibile 150 cm

Cromo lucido	AD144/5CR	116,00 €
Miele spazzolato PVD	AD144/5CGP	<b>NEW</b> 186,00 €

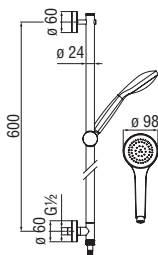

**Asta murale con presa acqua ø 1/2"**

- Supporto doccetta scorrevole e orientabile
- Doccetta monogetto e flessibile 150 cm

Cromo lucido	AD140/28CR	302,00 €
--------------	------------	----------

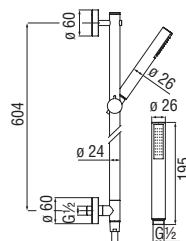

**Asta murale con presa acqua  $\varnothing$  1/2"**

- Supporto doccetta scorrevole e orientabile
- Doccetta monogetto e flessibile 150 cm

Cromo lucido AD140/26CR 255,00 €

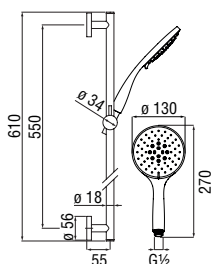

**Asta murale**

- Supporto doccetta scorrevole e orientabile
- Doccetta a 3 getti e flessibile 150 cm

Cromo lucido	AD140/54CR	MOD	190,00 €
Grafite spazzolato PVD	AD140/54GUP	NEW	304,00 €
Mora opaco	AD140/54BM	MOD	286,00 €

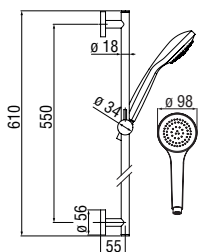

**Asta murale**

- Supporto doccetta scorrevole e orientabile
- Doccetta monogetto e flessibile 150 cm

Cromo lucido AD140/36CR 139,00 €

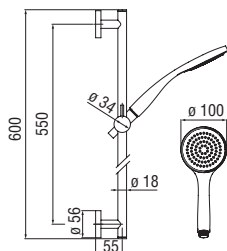

**Asta murale**

- Supporto doccetta scorrevole e orientabile
- Doccetta monogetto e flessibile 150 cm

Cromo lucido AD140/51CR 128,00 €

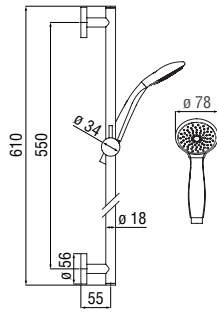

**Asta murale**

- Supporto doccetta scorrevole e orientabile
- Doccetta monogetto e flessibile 150 cm

Cromo lucido AD140/39CR 120,00 €

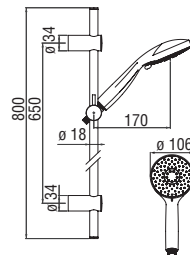

**Asta murale**

- Supporto doccetta scorrevole e orientabile
- Doccetta a 3 getti e flessibile 150 cm

Cromo lucido AD140/34CR 180,00 €

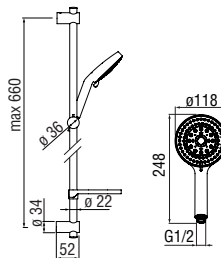

**Asta murale**

- Attacco regolabile
- Supporto doccetta scorrevole e orientabile
- Doccetta a 5 getti e flessibile 150 cm
- Mensola orientabile e removibile

Cromo lucido AD140/62CR 80,00 €

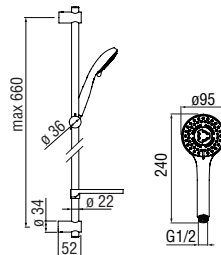

**Asta murale**

- Attacco regolabile
- Supporto doccetta scorrevole e orientabile
- Doccetta a 3 getti e flessibile 150 cm
- Mensola orientabile e removibile

Cromo lucido AD140/61CR 65,00 €

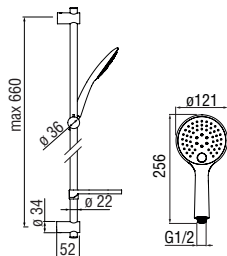

**Asta murale**

- Attacco regolabile
- Supporto doccetta scorrevole e orientabile
- Doccetta a 3 getti e flessibile 150 cm
- Mensola orientabile e removibile

Cromo lucido AD140/63CR 75,00 €

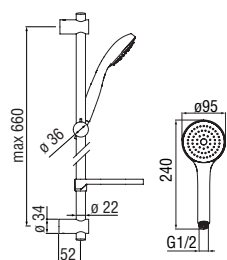

**Asta murale**

- Attacco regolabile
- Supporto doccetta scorrevole e orientabile
- Doccetta monogetto e flessibile 150 cm
- Mensola orientabile e removibile

Cromo lucido AD140/60CR 62,00 €

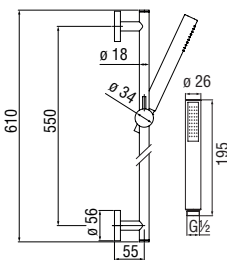

**Asta murale**

- Supporto doccetta scorrevole e orientabile
- Doccetta monogetto e flessibile 150 cm

Cromo lucido	AD140/37CR	139,00 €
Inox spazzolato	AD140/37IX	208,00 €
Grafite spazzolato PVD	AD140/37GUP	223,00 €
Mora opaco	AD140/37BM	208,00 €
Neve opaco	AD140/37WM	208,00 €
Miele spazzolato PVD	AD140/37CGP	<b>NEW</b> 223,00 €
Caffè spazzolato	AD140/37SB	<b>NEW</b> 223,00 €
Tramonto lucido PVD	AD140/37RCP	223,00 €
Argilla spazzolato PVD	AD140/37RTP	223,00 €

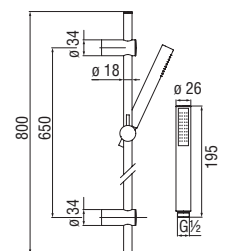

**Asta murale**

- Supporto doccetta scorrevole e orientabile
- Doccetta monogetto e flessibile 150 cm

Cromo lucido AD140/18CR 148,00 €

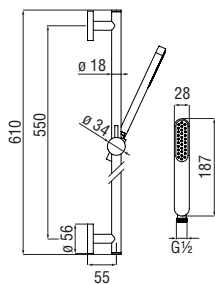

**Asta murale**

- Supporto doccetta scorrevole e orientabile
- Doccetta monogetto e flessibile 150 cm

Cromo lucido	AD140/53CR	<b>MOD</b>	142,00 €
Mora opaco	AD140/53BM	<b>MOD</b>	213,00 €

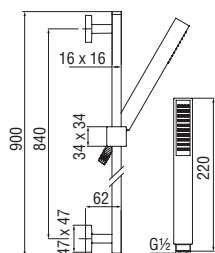

**Asta murale**

- Supporto doccetta scorrevole e orientabile
- Doccetta monogetto e flessibile 150 cm

Cromo lucido	AD140/21CR		305,00 €
Inox spazzolato	AD140/21IX		457,00 €
Mora opaco	AD140/21BM		457,00 €

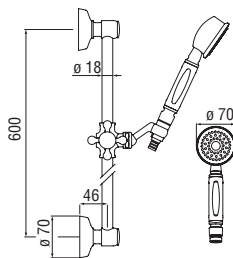

**Asta murale**

- Supporto doccetta scorrevole e orientabile
- Doccetta monogetto e flessibile 150 cm

Cromo lucido	AD140/48CR		394,00 €
Miele spazzolato PVD	AD140/48CGP	<b>NEW</b>	630,00 €
Caffè spazzolato	AD140/48SB	<b>NEW</b>	630,00 €

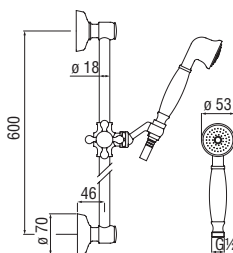

**Asta murale**

- Supporto doccetta scorrevole e orientabile
- Doccetta monogetto e flessibile 150 cm

Cromo lucido	AD140/10CR		271,00 €
Miele spazzolato PVD	AD140/10CGP	<b>NEW</b>	434,00 €

ASTE MURALI

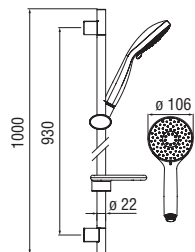

**Asta murale**

- Supporto doccetta scorrevole e orientabile
- Doccetta a 3 getti e flessibile 150 cm
- Piano porta oggetti

Cromo lucido AD140/41CR 137,00 €

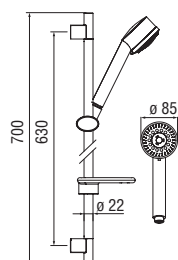

**Asta murale**

- Supporto doccetta scorrevole e orientabile
- Doccetta a 3 getti e flessibile 150 cm
- Piano porta oggetti

Cromo lucido AD140/40CR 120,00 €

DOCCETTE

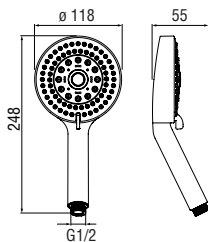

**Doccetta a 5 getti (Abs)**

- Attacco ø 1/2"

Cromo lucido AD142/188CR 42,00 €

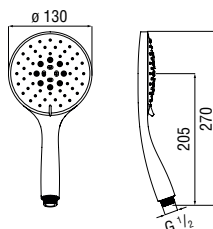

**Doccetta a 3 getti (Abs)**

- Attacco ø 1/2"

Cromo lucido	AD142/201CR	<b>NEW</b>	93,00 €
Grafite spazzolato PVD	AD142/201GUP	<b>NEW</b>	149,00 €
Mora opaco	AD142/201BM	<b>NEW</b>	140,00 €



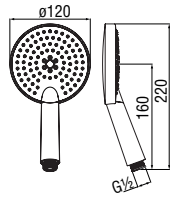

**Doccetta a 3 getti (Abs)**

- Attacco ø 1/2"
- Comando a pulsante

Cromo lucido AD142/179CR 96,00 €

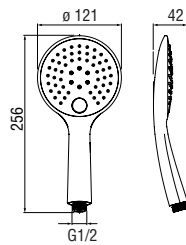

**Doccetta a 3 getti (Abs)**

- Attacco ø 1/2"
- Comando a pulsante

Cromo lucido AD142/189CR 38,00 €

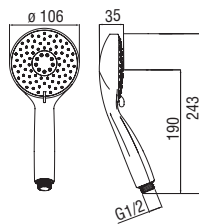

**Doccetta a 3 getti (Abs)**

- Attacco ø 1/2"

Cromo lucido AD142/143CR 80,00 €

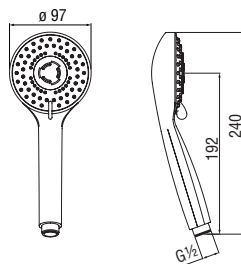

**Doccetta a 3 getti (Abs)**

- Attacco ø 1/2"

Cromo lucido AD142/178CR 40,00 €

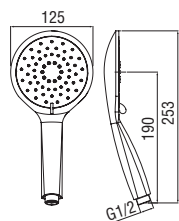

**Doccetta a 2 getti (Abs)**

· Attacco ø 1/2"

Cromo lucido AD142/161CR 70,00 €

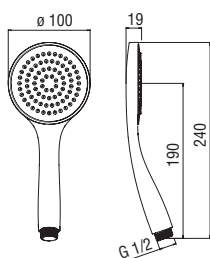

**Doccetta monogetto (Abs)**

· Attacco ø 1/2"

Cromo lucido AD142/130CCR 67,00 €

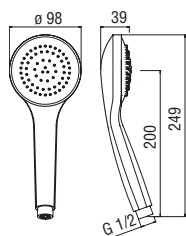

**Doccetta monogetto (Abs)**

· Attacco ø 1/2"

Cromo lucido AD142/80CR 47,00 €

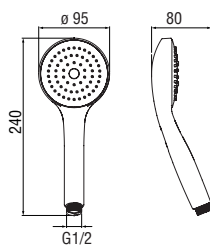

**Doccetta monogetto (Abs)**

· Attacco ø 1/2"

Cromo lucido AD142/186CR 23,00 €

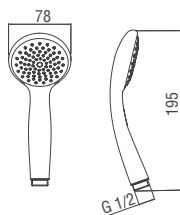

**Doccetta monogetto (Abs)**

· Attacco ø 1/2"

Cromo lucido	AD142/145CR	22,00 €
--------------	-------------	---------

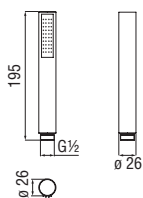

**Doccetta monogetto (Abs)**

· Attacco ø 1/2"

Cromo lucido	AD142/91CR	42,00 €
Inox spazzolato	AD142/91IX	63,00 €
Grafite spazzolato PVD	AD142/91GUP	67,00 €
Mora opaco	AD142/91BM	63,00 €
Neve opaco	AD142/91WM	63,00 €
Miele spazzolato PVD	AD142/91CGP	NEW 67,00 €
Caffè spazzolato	AD142/91SB	NEW 67,00 €
Tramonto lucido PVD	AD142/91RCP	67,00 €
Argilla spazzolato PVD	AD142/91RTP	67,00 €

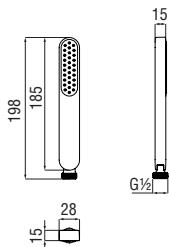

**Doccetta monogetto (Abs)**

· Attacco ø 1/2"

Cromo lucido	AD142/200CR	NEW 45,00 €
Mora opaco	AD142/200BM	NEW 68,00 €

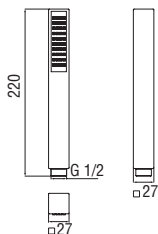

**Doccetta monogetto (Abs)**

· Attacco ø 1/2"

Cromo lucido	AD142/67CR	48,00 €
Inox spazzolato	AD142/67IX	74,00 €
Mora opaco	AD142/67BM	74,00 €

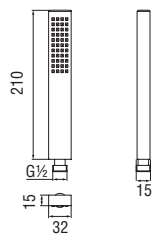

**Doccetta monogetto (Ottone)**

· Attacco ø 1/2"

Cromo lucido	AD142/124CR	82,00 €
--------------	-------------	---------

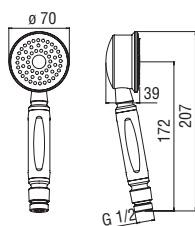

**Doccetta monogetto (Ottone)**

· Attacco ø 1/2"

Cromo lucido	AD142/153CR	170,00 €
Miele spazzolato PVD	AD142/153CGP	<b>NEW</b> 272,00 €
Caffè spazzolato	AD142/153SB	<b>NEW</b> 272,00 €

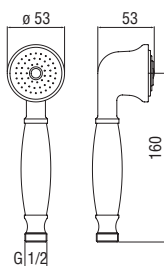

**Doccetta monogetto (Ottone)**

· Attacco ø 1/2"

Cromo lucido	AD142/31CR	46,00 €
Miele spazzolato PVD	AD142/31CGP	<b>NEW</b> 74,00 €

PRESE ACQUA

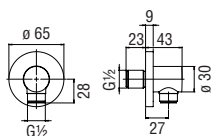

**Presca acqua**

· Uscita ø 1/2"

Cromo lucido	AD150/12CR	48,00 €
Inox spazzolato	AD150/12IX	74,00 €
Grafite spazzolato PVD	AD150/12GUP	79,00 €
Mora opaco	AD150/12BM	74,00 €
Neve opaco	AD150/12WM	74,00 €
Miele spazzolato PVD	AD150/12CGP	<b>NEW</b> 79,00 €
Caffè spazzolato	AD150/12SB	<b>NEW</b> 79,00 €
Tramonto lucido PVD	AD150/12RCP	79,00 €
Argilla spazzolato PVD	AD150/12RTP	79,00 €

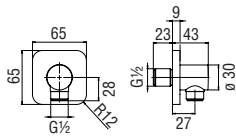
**Presa acqua**· Uscita  $\varnothing$  1/2"

Cromo lucido	AD150/14CR	54,00 €
--------------	------------	---------

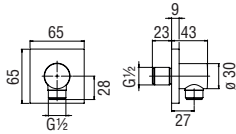
**Presa acqua**· Uscita  $\varnothing$  1/2"

Cromo lucido	AD150/18CR	69,00 €
Inox spazzolato	AD150/18IX	106,00 €
Mora opaco	AD150/18BM	106,00 €

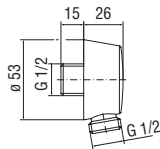
**Presa acqua**· Uscita  $\varnothing$  1/2"

Cromo lucido	AD150CR	23,00 €
Miele spazzolato PVD	AD150CGP	<b>NEW</b> 37,00 €
Caffè spazzolato	AD150SB	<b>NEW</b> 37,00 €

**Presa acqua con supporto**

· Supporto doccetta fisso rivestito in Teflon

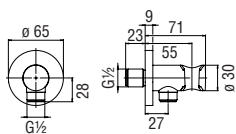
· Uscita  $\varnothing$  1/2"

Cromo lucido	AD150/17CR	54,00 €
Inox spazzolato	AD150/17IX	82,00 €
Grafite spazzolato PVD	AD150/17GUP	86,00 €
Mora opaco	AD150/17BM	82,00 €
Neve opaco	AD150/17WM	82,00 €
Miele spazzolato PVD	AD150/17CGP	<b>NEW</b> 86,00 €
Caffè spazzolato	AD150/17SB	<b>NEW</b> 86,00 €
Tramonto lucido PVD	AD150/17RCP	86,00 €
Argilla spazzolato PVD	AD150/17RTP	86,00 €

**Preso acqua con supporto**

- Supporto doccetta fisso rivestito in Teflon
- Uscita ø 1/2"

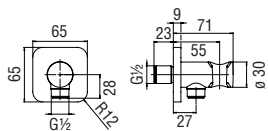

Cromo lucido	AD150/82CR	64,00 €
--------------	------------	---------

**Preso acqua con supporto**

- Supporto doccetta fisso rivestito in Teflon
- Uscita ø 1/2"

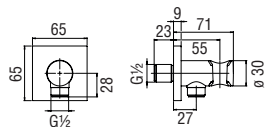

Cromo lucido	AD150/19CR	72,00 €
Inox spazzolato	AD150/19IX	109,00 €
Mora opaco	AD150/19BM	109,00 €

**Preso acqua con supporto**

- Supporto doccetta orientabile
- Uscita ø 1/2"

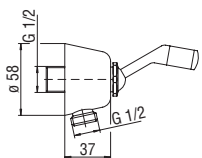

Cromo lucido	AD149CR	48,00 €
Miele spazzolato PVD	AD149CGP	<b>NEW</b> 77,00 €
Caffè spazzolato	AD149SB	<b>NEW</b> 77,00 €

SUPPORTI

**Supporto doccetta (Abs)**

- A snodo

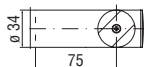

Cromo lucido	AD147/4CR	25,00 €
Inox spazzolato	AD147/4IX	40,00 €
Grafite spazzolato PVD	AD147/4GUP	42,00 €
Mora opaco	AD147/4BM	40,00 €
Neve opaco	AD147/4WM	40,00 €
Miele spazzolato PVD	AD147/4CGP	<b>NEW</b> 42,00 €
Caffè spazzolato	AD147/4SB	<b>NEW</b> 42,00 €
Tramonto lucido PVD	AD147/4RCP	42,00 €
Argilla spazzolato PVD	AD147/4RTP	42,00 €

**Supporto doccetta (Abs)**

· A snodo

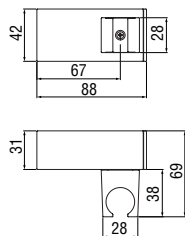

Cromo lucido	AD147/23CR	42,00 €
Inox spazzolato	AD147/23IX	63,00 €
Mora opaco	AD147/23BM	63,00 €

**Supporto doccetta (Abs)**

· Fisso

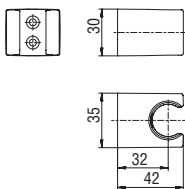

Cromo lucido	AD147/24CR	15,00 €
--------------	------------	---------

**Supporto doccetta**

· A snodo

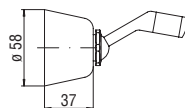

Cromo lucido	AD148/1CR	46,00 €
Miele spazzolato PVD	AD148/1CGP	<b>NEW</b> 74,00 €
Caffè spazzolato	AD148/1SB	<b>NEW</b> 74,00 €

**Supporto doccetta (Abs)**

· A snodo

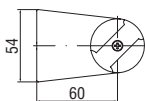

Cromo lucido	AD147/2CR	23,00 €
--------------	-----------	---------

**Supporto doccetta (Abs)**

· Fisso

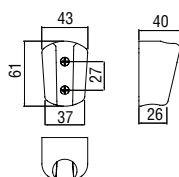

Cromo lucido AD147/1CR 15,00 €

**Supporto doccetta (Abs)**

· Fisso

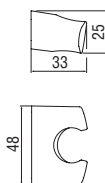

Cromo lucido AD147/9CR 6,00 €

**Supporto doccetta**

· Supporto doccetta scorrevole e orientabile

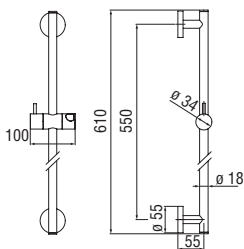

Cromo lucido	AD140/51RCR	75,00 €
Inox spazzolato	AD140/51RIX	113,00 €
Grafite spazzolato PVD	AD140/51RGUP	<b>NEW</b> 120,00 €
Mora opaco	AD140/51RBM	113,00 €
Neve opaco	AD140/51RWM	113,00 €

**Supporto doccetta**

- Supporto doccetta scorrevole e orientabile
- Attacco regolabile

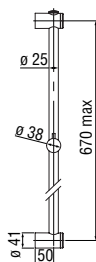

Cromo lucido AD140/55RCR 78,00 €



**Supporto doccia**

- Supporto doccia scorrevole e orientabile

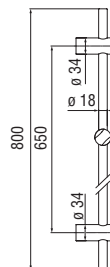

Cromo lucido	AD140/18RCR	78,00 €
--------------	-------------	---------

**Supporto doccia**

- Supporto doccia scorrevole e orientabile
- Scorrimento regolabile tramite pulsante
- Attacchi regolabili

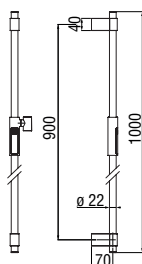

Cromo lucido	AD140/56RCR	281,00 €
--------------	-------------	----------

**Supporto doccia**

- Supporto doccia scorrevole e orientabile

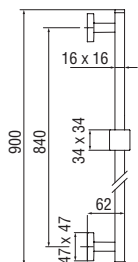

Cromo lucido	AD140/21RCR	237,00 €
Inox spazzolato	AD140/21RIX	355,00 €
Mora opaco	AD140/21RBM	355,00 €

**Supporto doccia**

- Supporto doccia scorrevole e orientabile

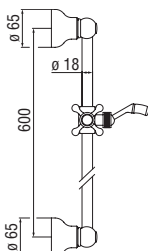

Cromo lucido	AD140/10RCR	203,00 €
Miele spazzolato PVD	AD140/10RCGP	<b>NEW</b> 325,00 €
Caffè spazzolato	AD140/10RSB	<b>NEW</b> 325,00 €

**Flessibile (Abs)**

- Doppia calotta conica ø 1/2"
- Dimensione 150 cm



Cromo lucido	AD135/43CR	23,00 €
Inox spazzolato	AD135/43IX	37,00 €
Mora opaco	AD135/57BM	37,00 €
Neve opaco	AD135/57WM	37,00 €

**Flessibile (Abs)**

- Doppia calotta conica ø 1/2"
- Dimensione 100 cm



Cromo lucido	AD135/58CR	21,00 €
--------------	------------	---------

**Flessibile (Ottone)**

- Calotta conica ø 1/2"
- Dimensione 150 cm
- Doppia aggraffatura



Cromo lucido	AD135/5CR	42,00 €
Miele spazzolato PVD	AD135/5CGP	<b>NEW</b> 67,00 €
Caffè spazzolato	AD135/5SB	<b>NEW</b> 67,00 €

DOCCIA

# TERMOSTATICI ESTERNI

Centro Stile Nobili

Tutti i termostatici esterni, ideali per la realizzazione di un ambiente dove tecnologia e design trovano la loro massima espressione. Dotati della più avanzata tecnologia Nobili Thermotech® con blocco di sicurezza della temperatura a 38°C, rispondono in maniera fulminea ad un'eventuale variazione termica.



PLAIN

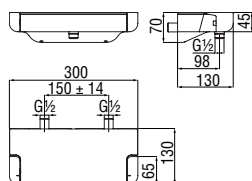

**Termostatico esterno**

- Blocco di sicurezza 38° C
- Piano mensola in vetro
- Uscita ø 1/2"
- Filtri di ricambio cartuccia inclusi nella confezione

Cromo l. e vetro bianco	PN115030CR	435,00 €
Cromo l. e vetro nero	PN115030BCR	435,00 €

 RCR200/37  
39,00 €

 RCR201/6  
58,00 €

THICE

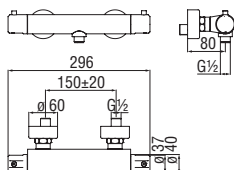

**Termostatico esterno con corpo freddo**

- Corpo freddo
- Blocco di sicurezza 38° C
- Valvole antiritorno
- Uscita ø 1/2"

Cromo lucido	TH85530CR	221,00 €
--------------	-----------	----------

 RCR200/33S  
39,00 €

 RCR201/56A  
58,00 €

VELIS

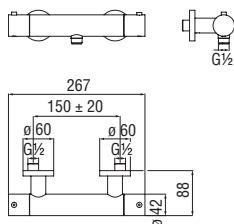

**Termostatico esterno**

- Blocco di sicurezza 38° C
- Valvole antiritorno
- Uscita ø 1/2"

Cromo lucido	VE125030CR	487,00 €
Inox spazzolato	VE125030IX	732,00 €
Grafite spazzolato PVD	VE125030GUP	779,00 €
Miele spazzolato PVD	VE125030CGP	<b>NEW</b> 779,00 €
Caffè spazzolato	VE125030SB	<b>NEW</b> 779,00 €
Tramonto lucido PVD	VE125030RCP	779,00 €
Argilla spazzolato PVD	VE125030RTP	779,00 €

 RCR201/56  
58,00 €

 RVT200/28  
21,00 €

DRESS

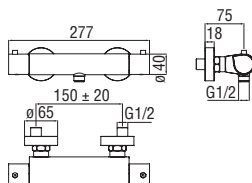

**Termostatico esterno**

- Blocco di sicurezza 38° C
- Valvole antiritorno
- Uscita ø 1/2"
- Filtri di ricambio cartuccia inclusi nella confezione

Cromo and Colour	DS106030C--	415,00 €
Cromo and Wood	DS106030C--	538,00 €
Inox T.E.A.+ and Fenix	DS106030T--	664,00 €
Cromo and Matter	DS106030C--	664,00 €
Cromo and Carbon	DS106030C--	1.054,00 €
Inox T.E.A.+ and Carbon	DS106030T--	1.054,00 €
Cromo and Guilloché	DS106030C--	1.244,00 €

 RCR201/5  
58,00 €

 RVT200/26  
18,00 €

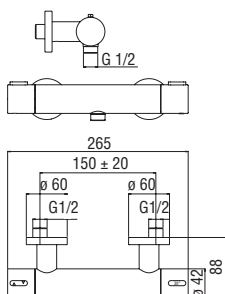

**Termostatico esterno**

- Blocco di sicurezza 38° C
- Valvole antiritorno
- Uscita ø 1/2"

Cromo lucido LK0003OCR 531,00 €



RCR201/56  
58,00 €



RVT200/28  
21,00 €

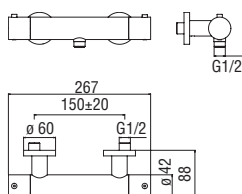

**Termostatico esterno**

- Blocco di sicurezza 38° C
- Valvole antiritorno
- Uscita ø 1/2"

Cromo lucido	LV0003OCR	487,00 €
Inox spazzolato	LV0003OIX	732,00 €
Grafite spazzolato PVD	LV0003OGUP	<b>NEW</b> 779,00 €
Mora opaco	LV0003OBM	732,00 €
Neve opaco	LV0003OWM	732,00 €
Miele spazzolato PVD	LV0003CCGP	<b>NEW</b> 779,00 €
Argilla spazzolato PVD	LV0003ORTP	<b>NEW</b> 779,00 €



RCR201/56  
58,00 €



RVT200/28  
21,00 €

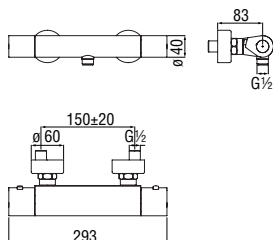

**Termostatico esterno**

- Blocco di sicurezza 38° C
- Valvole antiritorno
- Uscita ø 1/2"
- Filtri di ricambio cartuccia inclusi nella confezione

Cromo lucido YO12603OCR 218,00 €  
Mora opaco YO12603OBM 328,00 €



RCR201/6  
58,00 €



RVT200/26  
18,00 €

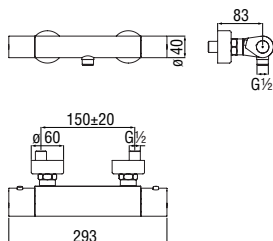

**Termostatico esterno**

- Blocco di sicurezza 38° C
- Valvole antiritorno
- Uscita ø 1/2"
- Filtri di ricambio cartuccia inclusi nella confezione

Cromo lucido SE12403OCR 218,00 €  
Inox spazzolato SE12403OIX **NEW** 328,00 €  
Mora opaco SE12403OBM 328,00 €



RCR201/6  
58,00 €

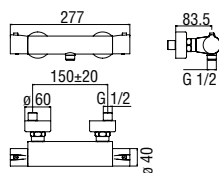

RVT200/26  
18,00 €

**Termostatico esterno**

- Blocco di sicurezza 38° C
- Valvole antiritorno
- Uscita ø 1/2"
- Filtri di ricambio cartuccia inclusi nella confezione

Cromo lucido	VV103030CR	200,00 €
Mora opaco	VV103030BM	299,00 €

RCR201/6  
58,00 €RVT200/26  
18,00 €

## UP

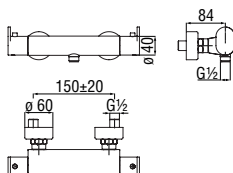
**Termostatico esterno**

- Blocco di sicurezza 38° C
- Valvole antiritorno
- Uscita ø 1/2"
- Filtri di ricambio cartuccia inclusi nella confezione

Cromo lucido	UP94030CR	245,00 €
Mora opaco	UP94030BM	368,00 €

RCR201/6  
58,00 €RVT200/26  
18,00 €

## RAY

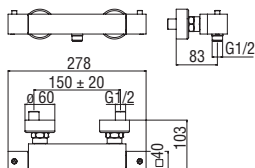
**Termostatico esterno**

- Blocco di sicurezza 38° C
- Valvole antiritorno
- Uscita ø 1/2"
- Filtri di ricambio cartuccia inclusi nella confezione

Cromo lucido	RY00030CR	508,00 €
--------------	-----------	----------

RCR201/5  
58,00 €RVT200/26  
18,00 €

## MIA

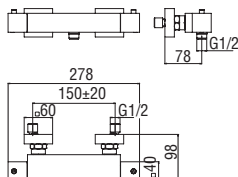
**Termostatico esterno**

- Blocco di sicurezza 38° C
- Valvole antiritorno
- Uscita ø 1/2"
- Filtri di ricambio cartuccia inclusi nella confezione

Cromo lucido	MQ102030CR	529,00 €
Inox spazzolato	MQ102030IX	794,00 €
Mora opaco	MQ102030BM	794,00 €

RCR201/5  
58,00 €RVT200/26  
18,00 €

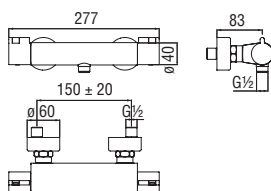

**Termostatico esterno**

- Blocco di sicurezza 38° C
- Valvole antiritorno
- Sistema anticalcare
- Uscita ø 1/2"
- Filtri di ricambio cartuccia inclusi nella confezione

Cromo lucido	AB8703OCR	222,00 €
Mora opaco	AB87030BM	<b>NEW</b> 300,00 €

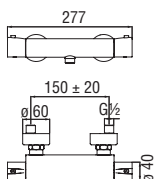

**Termostatico esterno**

- Blocco di sicurezza 38° C
- Valvole antiritorno
- Sistema anticalcare
- Uscita ø 1/2"
- Filtri di ricambio cartuccia inclusi nella confezione

Cromo lucido	SY9703OCR	217,00 €
--------------	-----------	----------

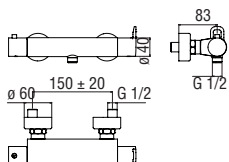

**Termostatico esterno**

- Blocco di sicurezza 38° C
- Valvole antiritorno
- Uscita ø 1/2"
- Filtri di ricambio cartuccia inclusi nella confezione

Cromo lucido	RD0043OCR	239,00 €
--------------	-----------	----------

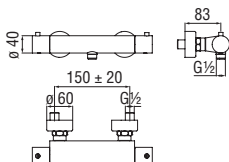

**Termostatico esterno**

- Blocco di sicurezza 38° C
- Valvole antiritorno
- Uscita ø 1/2"
- Filtri di ricambio cartuccia inclusi nella confezione

Cromo lucido	TG8533OCR	213,00 €
Inox spazzolato	TG85330IX	<b>NEW</b> 319,00 €
Mora opaco	TG85330BM	<b>NEW</b> 319,00 €



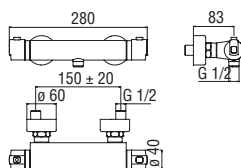

**Termostatico esterno**

- Blocco di sicurezza 38° C
- Valvole antiritorno
- Uscita ø 1/2"
- Filtri di ricambio cartuccia inclusi nella confezione

Cromo lucido TY85330CR 181,00 €

 RCR201/6  
58,00 €

 RVT200/26  
18,00 €

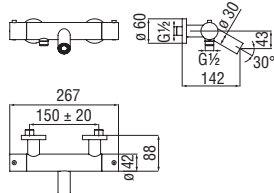

**Termostatico esterno**

- Blocco di sicurezza 38° C
- Valvole antiritorno
- Aeratore anticalcare M 24 x 1
- Uscita ø 1/2"

Cromo lucido	VE125010/1CR	611,00 €
Inox spazzolato	VE125010/1IX	918,00 €
Grafite spazzolato PVD	VE125010/1GUP	978,00 €
Miele spazzolato PVD	VE125010/1CGP	<b>NEW</b> 978,00 €
Caffè spazzolato	VE125010/1SB	<b>NEW</b> 978,00 €
Tramonto lucido PVD	VE125010/1RCP	978,00 €
Argilla spazzolato PVD	VE125010/1RTP	978,00 €

 RCR201/56  
58,00 €

 RCR201/57  
51,00 €

 RAEK222/22  
45,00 € - 10 pz.

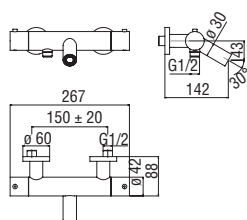

**Termostatico esterno**

- Blocco di sicurezza 38° C
- Valvole antiritorno
- Aeratore anticalcare M 24 x 1
- Uscita ø 1/2"

Cromo lucido	LV00010/1CR	611,00 €
Inox spazzolato	LV00010/1IX	918,00 €
Grafite spazzolato PVD	LV00010/1GUP	<b>NEW</b> 978,00 €
Mora opaco	LV00010/1BM	918,00 €
Neve opaco	LV00010/1WM	918,00 €
Miele spazzolato PVD	LV00010/1CGP	<b>NEW</b> 978,00 €
Argilla spazzolato PVD	LV00010/1RTP	<b>NEW</b> 978,00 €

 RCR201/56  
58,00 €

 RCR201/57  
51,00 €

 RAEK222/22  
45,00 € - 10 pz.

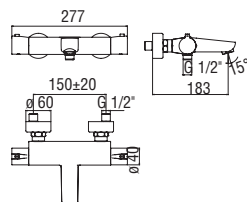

**Termostatico esterno**

- Blocco di sicurezza 38° C
- Valvole antiritorno
- Aeratore anticalcare M 28 x 1
- Uscita ø 1/2"
- Filtri di ricambio cartuccia inclusi nella confezione

Cromo lucido	VV103010/1CR	244,00 €
Mora opaco	VV103010/1BM	365,00 €

 RCR201/5  
58,00 €

 RCR201/70  
39,00 €

 RAEK219/41CR  
47,00 € - 5 pz.



UP

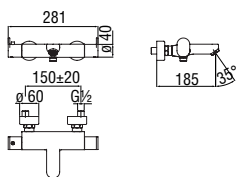

**Termostatico esterno**

- Blocco di sicurezza 38° C
- Valvole antiritorno
- Aeratore anticalcare M 28 x 1
- Deviatore a 2 vie ceramico
- Uscita ø 1/2"
- Filtri di ricambio cartuccia inclusi nella confezione

Cromo lucido	UP94010/1CR	331,00 €
Mora opaco	UP94010/1BM	497,00 €

 RCR201/5  
58,00 €

 RCR201/70  
39,00 €

 RAEK219/41CR  
47,00 € - 5 pz.

RAY

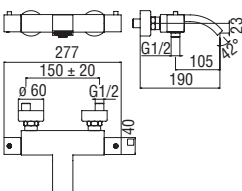

**Termostatico esterno**

- Blocco di sicurezza 38° C
- Valvole antiritorno
- Aeratore anticalcare
- Uscita ø 1/2"
- Filtri di ricambio cartuccia inclusi nella confezione

Cromo lucido	RY00010/1CR	698,00 €
--------------	-------------	----------

 RCR201/5  
58,00 €

 RCR201/70  
39,00 €

 RAEK219/27  
96,00 € - 5 pz.

MIA

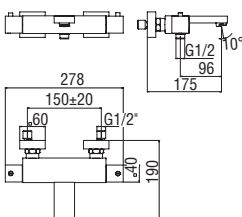

**Termostatico esterno**

- Blocco di sicurezza 38° C
- Valvole antiritorno
- Aeratore anticalcare M 24 x 1
- Uscita ø 1/2"
- Filtri di ricambio cartuccia inclusi nella confezione

Cromo lucido	MQ102010/1CR	730,00 €
Inox spazzolato	MQ102010/1IX	1.093,00 €
Mora opaco	MQ102010/1BM	1.093,00 €

 RCR201/5  
58,00 €

 RCR201/70  
39,00 €

 RAEK220/14CR  
45,00 € - 10 pz.

ABC

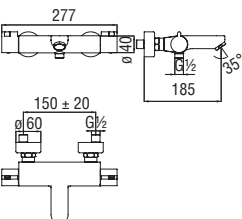

**Termostatico esterno**

- Blocco di sicurezza 38° C
- Valvole antiritorno
- Sistema anticalcare
- Aeratore anticalcare M 28 x 1
- Deviatore a 2 vie ceramico
- Uscita ø 1/2"
- Filtri di ricambio cartuccia inclusi nella confezione

Cromo lucido	AB87010/1CR	308,00 €
Mora opaco	AB87010/1BM	<b>NEW</b> 416,00 €

 RCR201/5  
58,00 €

 RCR201/70  
39,00 €

 RAEK219/4CR  
43,00 € - 5 pz.

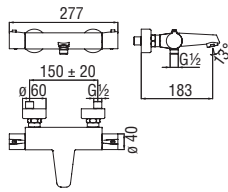

**Termostatico esterno**

- Blocco di sicurezza 38° C
- Valvole antiritorno
- Aeratore anticalcare M 28 x 1
- Uscita ø 1/2"
- Filtri di ricambio cartuccia inclusi nella confezione

Cromo lucido SY97010/1CR 362,00 €



RCR201/5  
58,00 €



RCR201/70  
39,00 €



RAEK219/4CR  
43,00 € - 5 pz.

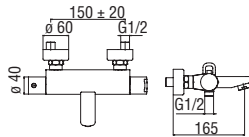

**Termostatico esterno**

- Blocco di sicurezza 38° C
- Valvole antiritorno
- Aeratore anticalcare M 28 x 1
- Uscita ø 1/2"
- Filtri di ricambio cartuccia inclusi nella confezione

Cromo lucido RD00410/1CR 343,00 €



RCR201/5  
58,00 €



RCR201/70  
39,00 €



RAEK219/4CR  
43,00 € - 5 pz.

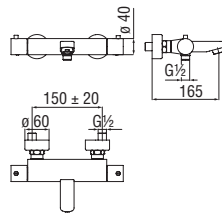

**Termostatico esterno**

- Blocco di sicurezza 38° C
- Valvole antiritorno
- Aeratore anticalcare M 28 x 1
- Deviatore a 2 vie ceramico
- Uscita ø 1/2"
- Filtri di ricambio cartuccia inclusi nella confezione

Cromo lucido	TG85310/1CR	313,00 €
Inox spazzolato	TG85310/1IX	<b>NEW</b> 469,00 €
Mora opaco	TG85310/1BM	<b>NEW</b> 469,00 €



RCR201/5  
58,00 €



RCR201/70  
39,00 €



RAEK219/4CR  
43,00 € - 5 pz.

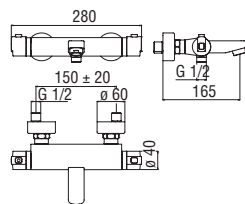

**Termostatico esterno**

- Blocco di sicurezza 38° C
- Valvole antiritorno
- Aeratore anticalcare M 28 x 1
- Deviatore a 2 vie ceramico
- Uscita ø 1/2"
- Filtri di ricambio cartuccia inclusi nella confezione

Cromo lucido TY85310/1CR 276,00 €



RCR201/5  
58,00 €



RCR201/70  
39,00 €



RAEK219/4CR  
43,00 € - 5 pz.

VELIS

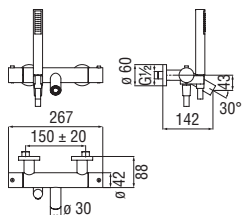

**Termostatico esterno con set doccia**

- Blocco di sicurezza 38° C
- Valvole antiritorno
- Aeratore anticalcare M 24 x 1
- Doccetta monogetto e flessibile 150 cm

Cromo lucido	VE125010/2CR	692,00 €
Inox spazzolato	VE125010/2IX	1.038,00 €
Grafite spazzolato PVD	VE125010/2GUP	1.107,00 €
Miele spazzolato PVD	VE125010/2CGP	<b>NEW</b> 1.107,00 €
Caffè spazzolato	VE125010/2SB	<b>NEW</b> 1.107,00 €
Tramonto lucido PVD	VE125010/2RCP	1.107,00 €
Argilla spazzolato PVD	VE125010/2RTP	1.107,00 €



RRC201/56  
58,00 €



RRC201/57  
51,00 €



RAEK222/22  
45,00 € - 10 pz.

LIKID

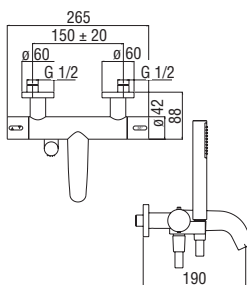

**Termostatico esterno con set doccia**

- Blocco di sicurezza 38° C
- Valvole antiritorno
- Aeratore anticalcare M 24 x 1
- Supporto doccetta fisso
- Doccetta monogetto e flessibile 150 cm

Cromo lucido	LK00010/2CR	755,00 €
--------------	-------------	----------



RRC201/56  
58,00 €



RRC201/57  
51,00 €



RAEK222/22  
45,00 € - 10 pz.

LIVE

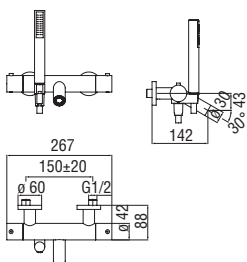

**Termostatico esterno con set doccia**

- Blocco di sicurezza 38° C
- Valvole antiritorno
- Aeratore anticalcare M 24 x 1
- Doccetta monogetto e flessibile 150 cm

Cromo lucido	LV00010/2CR	692,00 €
Inox spazzolato	LV00010/2IX	1.038,00 €
Grafite spazzolato PVD	LV00010/2GUP	<b>NEW</b> 1.107,00 €
Mora opaco	LV00010/2BM	1.038,00 €
Neve opaco	LV00010/2WM	1.038,00 €
Miele spazzolato PVD	LV00010/2CGP	<b>NEW</b> 1.107,00 €
Argilla spazzolato PVD	LV00010/2RTP	<b>NEW</b> 1.107,00 €



RRC201/56  
58,00 €



RRC201/57  
51,00 €



RAEK222/22  
45,00 € - 10 pz.

ACQUAVIVA

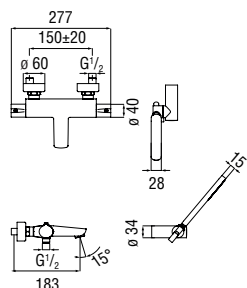

**Termostatico esterno con set doccia**

- Blocco di sicurezza 38° C
- Valvole antiritorno
- Aeratore anticalcare M 28 x 1
- Supporto doccetta orientabile
- Doccetta monogetto e flessibile 150 cm
- Filtri di ricambio cartuccia inclusi nella confezione

Cromo lucido	VV103010CR	<b>MOD</b> 329,00 €
Mora opaco	VV103010BM	<b>MOD</b> 492,00 €



RRC201/5  
58,00 €



RRC201/70  
39,00 €



RAEK219/41CR  
47,00 € - 5 pz.

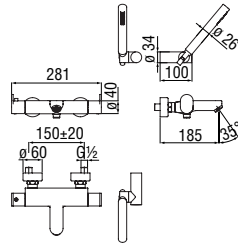

**Termostatico esterno con set doccia**

- Blocco di sicurezza 38° C
- Valvole antiritorno
- Aeratore anticalcare M 28 x 1
- Deviatore a 2 vie ceramico
- Doccetta monogetto, supporto orientabile e flessibile 150 cm
- Filtri di ricambio cartuccia inclusi nella confezione

Cromo lucido	UP94010CR	359,00 €
Mora opaco	UP94010BM	537,00 €



RCR201/5  
58,00 €



RCR201/70  
39,00 €



RAEK219/41CR  
47,00 € - 5 pz.

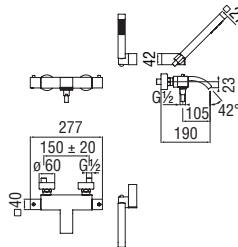

**Termostatico esterno con set doccia**

- Blocco di sicurezza 38° C
- Valvole antiritorno
- Aeratore anticalcare
- Supporto doccetta orientabile
- Doccetta monogetto e flessibile 150 cm
- Filtri di ricambio cartuccia inclusi nella confezione

Cromo lucido	RY00010CR	815,00 €
--------------	-----------	----------



RCR201/5  
58,00 €



RCR201/70  
39,00 €



RAEK219/27  
96,00 € - 5 pz.

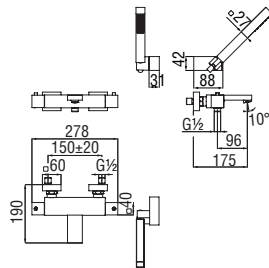

**Termostatico esterno con set doccia**

- Blocco di sicurezza 38° C
- Valvole antiritorno
- Aeratore anticalcare M 24 x 1
- Supporto doccetta orientabile
- Doccetta monogetto e flessibile 150 cm
- Filtri di ricambio cartuccia inclusi nella confezione

Cromo lucido	MQ102010CR	847,00 €
Inox spazzolato	MQ102010IX	1.273,00 €
Mora opaco	MQ102010BM	1.273,00 €



RCR201/5  
58,00 €



RCR201/70  
39,00 €



RAEK220/14CR  
45,00 € - 10 pz.

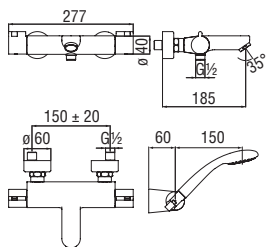

**Termostatico esterno con set doccia**

- Blocco di sicurezza 38° C
- Valvole antiritorno
- Aeratore anticalcare M 28 x 1
- Deviatore a 2 vie ceramico
- Supporto doccetta orientabile
- Doccetta monogetto e flessibile 150 cm
- Filtri di ricambio cartuccia inclusi nella confezione

Cromo lucido	AB87010CR	333,00 €
Mora opaco	AB87010BM	<b>NEW</b> 450,00 €



RCR201/5  
58,00 €



RCR201/70  
39,00 €



RAEK219/4CR  
43,00 € - 5 pz.

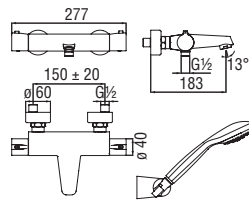

#### Termostatico esterno con set doccia

- Blocco di sicurezza 38° C
- Valvoline antiritorno
- Aeratore anticalcare M 28 x 1
- Supporto doccetta orientabile
- Doccetta monogetto e flessibile 150 cm
- Filtri di ricambio cartuccia inclusi nella confezione

Cromo lucido SY97010CR 422,00 €



RCR201/5  
58,00 €



RCR201/70  
39,00 €



RAEK219/4CR  
43,00 € - 5 pz.

#### NEW ROAD

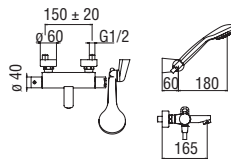

#### Termostatico esterno con set doccia

- Blocco di sicurezza 38° C
- Valvoline antiritorno
- Aeratore anticalcare M 28 x 1
- Supporto doccetta orientabile
- Doccetta monogetto e flessibile 150 cm
- Filtri di ricambio cartuccia inclusi nella confezione

Cromo lucido RDO0410CR 399,00 €



RCR201/5  
58,00 €



RCR201/70  
39,00 €



RAEK219/4CR  
43,00 € - 5 pz.



COLONNE DOCCIA

# COLONNE TERMOSTATICHE

Centro Stile Nobili

Energia, relax, comfort d'utilizzo: la gamma di colonne doccia termostatiche, dotate della cartuccia Nobili Thermotech® (realizzata utilizzando tecnopolimeri ad alte prestazioni, garanzia di elevata resistenza alla temperatura), in grado di delineare nuovi standard qualitativi aumentando la velocità di miscelazione dell'acqua e riducendo nettamente il tempo di risposta al cambiamento improvviso di temperatura.



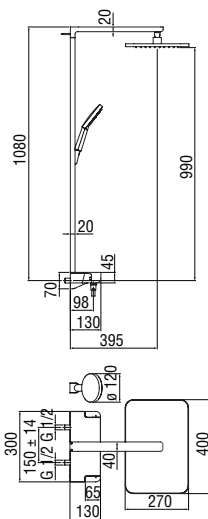

**Termostatico esterno**

- Blocco di sicurezza 38° C
- Soffione a snodo 400 x 270 mm
- Piano mensola in vetro
- Supporto doccetta fisso
- Doccetta a 3 getti e flessibile 150 cm
- Filtri di ricambio cartuccia inclusi nella confezione

Cromo l. e vetro bianco	PN115030/30CR	1.742,00 €
Cromo l. e vetro nero	PN115030/30BCR	1.742,00 €

 RCR201/5  
58,00 €

 RCR201/70  
39,00 €

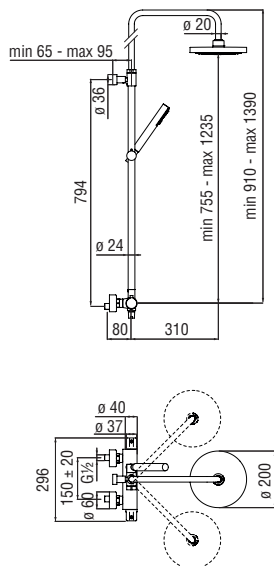

**Termostatico esterno con corpo freddo e rampa telescopica**

- Blocco di sicurezza 38° C
- Valvole antiritorno
- Soffione a snodo ø 200 mm
- Supporto doccetta scorrevole e orientabile
- Doccetta monogetto e flessibile 150 cm

Cromo lucido	TH85530/54CR	<b>NEW</b>	859,00 €
--------------	--------------	------------	----------

 RCR201/56A  
58,00 €

 RCR201/28  
39,00 €



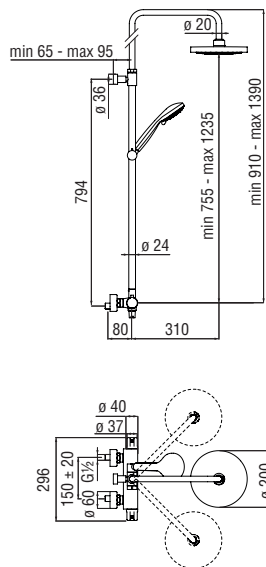

**Termostatico esterno con corpo freddo e rampa telescopica**

- Blocco di sicurezza 38° C
- Valvole antiritorno
- Soffione a snodo  $\varnothing$  200 mm
- Supporto doccetta scorrevole e orientabile
- Doccetta a 3 getti e flessibile 150 cm

Cromo lucido TH85530/55CR **NEW** 889,00 €



RCR201/56A  
58,00 €



RCR201/28  
39,00 €

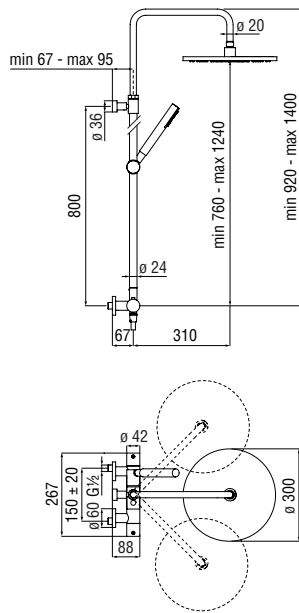

**Termostatico esterno con rampa telescopica**

- Blocco di sicurezza 38° C
- Valvole antiritorno
- Soffione a snodo  $\varnothing$  300 mm abs
- Supporto doccetta scorrevole e orientabile
- Doccetta monogetto e flessibile 150 cm

Cromo lucido	VE125030/51CR	<b>NEW</b>	1.199,00 €
Inox spazzolato	VE125030/51IX	<b>NEW</b>	1.799,00 €
Grafite spazzolato PVD	VE125030/51GUP	<b>NEW</b>	1.918,00 €
Mora opaco	VE125030/51BM	<b>NEW</b>	1.799,00 €
Neve opaco	VE125030/51WM	<b>NEW</b>	1.799,00 €
Miele spazzolato PVD	VE125030/51CGP	<b>NEW</b>	1.918,00 €
Caffè spazzolato	VE125030/51SB	<b>NEW</b>	1.918,00 €
Tramonto lucido PVD	VE125030/51RCP	<b>NEW</b>	1.918,00 €
Argilla spazzolato PVD	VE125030/51RTP	<b>NEW</b>	1.918,00 €



RCR201/56  
58,00 €



RCR201/57  
51,00 €

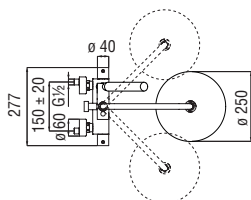
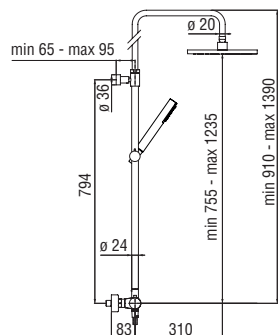

**Termostatico esterno con rampa telescopica**

- Blocco di sicurezza 38° C
- Valvole antiritorno
- Soffione a snodo ø 250 mm abs
- Supporto doccetta scorrevole e orientabile
- Doccetta monogetto e flessibile 150 cm
- Compatibile con mensola AV00141/5
- Filtri di ricambio cartuccia inclusi nella confezione

Cromo lucido	TD85330/52CR	<b>NEW</b>	799,00 €
Inox spazzolato	TD85330/52IX	<b>NEW</b>	1.199,00 €
Grafite spazzolato PVD	TD85330/52GUP	<b>NEW</b>	1.278,00 €
Mora opaco	TD85330/52BM	<b>NEW</b>	1.199,00 €
Neve opaco	TD85330/52WM	<b>NEW</b>	1.199,00 €
Miele spazzolato PVD	TD85330/52CGP	<b>NEW</b>	1.278,00 €

 RCR201/5  
58,00 €

 RCR201/70  
39,00 €

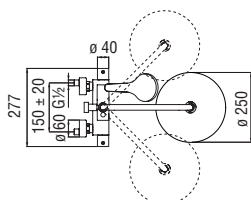
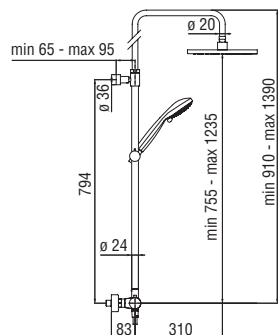

**Termostatico esterno con rampa telescopica**

- Blocco di sicurezza 38° C
- Valvole antiritorno
- Soffione a snodo ø 250 mm abs
- Supporto doccetta scorrevole e orientabile
- Doccetta a 3 getti e flessibile 150 cm
- Compatibile con mensola AV00141/5
- Filtri di ricambio cartuccia inclusi nella confezione

Cromo lucido	TD85330/53CR	<b>NEW</b>	819,00 €
--------------	--------------	------------	----------

 RCR201/5  
58,00 €

 RCR201/70  
39,00 €

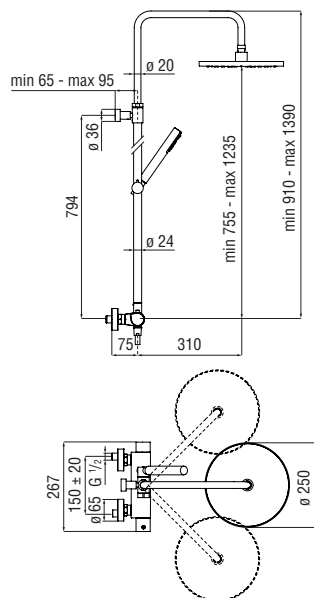

**Termostatico esterno con rampa telescopica**

- Blocco di sicurezza 38° C
- Valvole antiritorno
- Soffione a snodo  $\varnothing$  250 mm abs
- Supporto doccetta scorrevole e orientabile
- Doccetta monogetto e flessibile 150 cm
- Compatibile con mensola AV00141/5
- Filtri di ricambio cartuccia inclusi nella confezione

Cromo and Colour	DS106030/51C--	<b>NEW</b>	1.447,00 €
Cromo and Wood	DS106030/51C--	<b>NEW</b>	1.565,00 €
Inox T.E.A.+ and Fenix	DS106030/51T--	<b>NEW</b>	1.685,00 €
Cromo and Matter	DS106030/51C--	<b>NEW</b>	1.685,00 €
Cromo and Carbon	DS106030/51C--	<b>NEW</b>	1.965,00 €
Inox T.E.A.+ and Carbon	DS106030/51T--	<b>NEW</b>	1.965,00 €
Cromo and Guilloché	DS106030/51C--	<b>NEW</b>	2.244,00 €



RCR201/5  
58,00 €



RCR201/70  
39,00 €

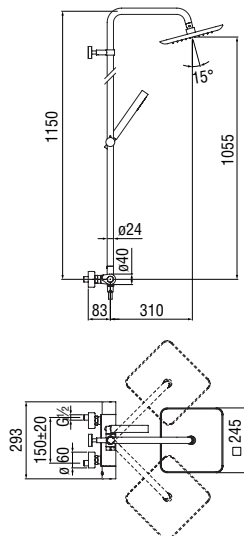

**Termostatico esterno**

- Blocco di sicurezza 38° C
- Valvole antiritorno
- Soffione a snodo 245 x 245 mm abs
- Supporto doccetta scorrevole e orientabile
- Doccetta monogetto e flessibile 150 cm
- Compatibile con mensola AV00141/5
- Filtri di ricambio cartuccia inclusi nella confezione

Cromo lucido	SE124030/30CR		768,00 €
Inox spazzolato	SE124030/30IX	<b>NEW</b>	1.151,00 €
Mora opaco	SE124030/30BM		1.151,00 €



RCR201/5  
58,00 €



RCR201/70  
39,00 €

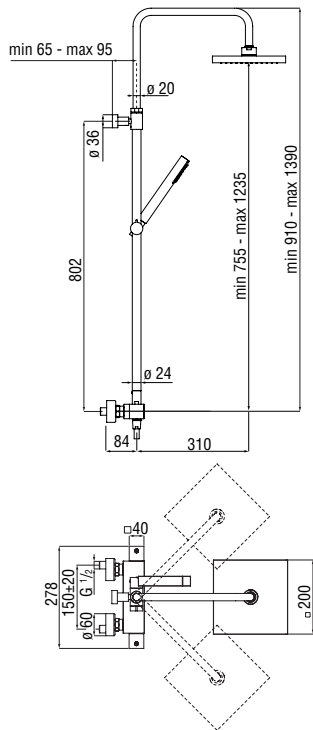

**Termostatico esterno con rampa telescopica**

- Blocco di sicurezza 38° C
- Valvole antiritorno
- Soffione a snodo 200 x 200 mm abs
- Supporto doccetta scorrevole e orientabile
- Doccetta monogetto e flessibile 150 cm
- Filtri di ricambio cartuccia inclusi nella confezione

Cromo lucido	QD00030/50CR	<b>NEW</b>	1.150,00 €
Inox spazzolato	QD00030/50IX	<b>NEW</b>	1.725,00 €
Mora opaco	QD00030/50BM	<b>NEW</b>	1.725,00 €

 RCR201/5  
58,00 €

 RCR201/70  
39,00 €

CARLOS PRIMERO

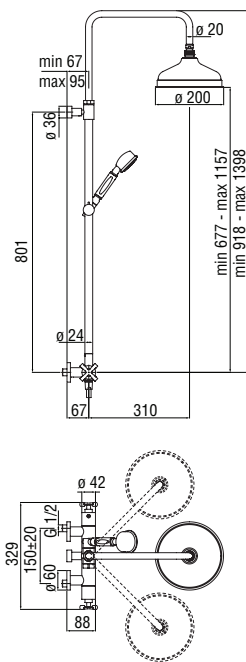

**Termostatico esterno con rampa telescopica**

- Blocco di sicurezza 38° C
- Valvole antiritorno
- Soffione a snodo ø 200 mm
- Supporto doccetta scorrevole e orientabile
- Doccetta monogetto e flessibile 150 cm

Cromo lucido	CP030/50CR		1.318,00 €
Miele spazzolato PVD	CP030/50CGP	<b>NEW</b>	2.109,00 €
Caffè spazzolato	CP030/50SB	<b>NEW</b>	2.109,00 €

 RCR201/56  
58,00 €

 RCR201/57  
51,00 €

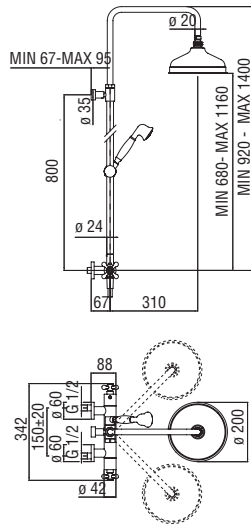

**Termostatico esterno con rampa telescopica**

- Blocco di sicurezza 38° C
- Valvole antiritorno
- Soffione a snodo  $\varnothing$  200 mm
- Supporto doccetta scorrevole e orientabile
- Doccetta monogetto e flessibile 150 cm

Cromo lucido	GRC0030/50CR	1.318,00 €
Miele spazzolato PVD	GRC0030/50CGP	<b>NEW</b> 2.109,00 €



RCR201/56  
58,00 €



RCR201/57  
51,00 €

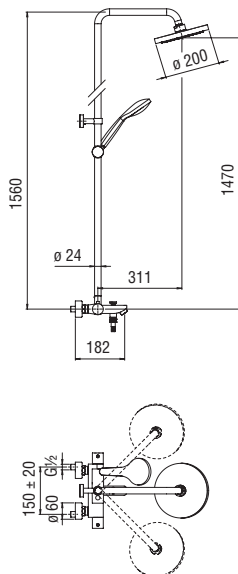

**Termostatico esterno per vasca**

- Blocco di sicurezza 38° C
- Valvole antiritorno
- Aeratore anticalcare M 28 x 1
- Soffione a snodo  $\varnothing$  200 mm
- Supporto doccetta scorrevole e orientabile
- Doccetta monogetto e flessibile 150 cm
- Compatibile con mensola AV00141/5
- Filtri di ricambio cartuccia inclusi nella confezione

Cromo lucido	TG85310/30CR	939,00 €
--------------	--------------	----------



RCR201/5  
58,00 €



RCR201/70  
39,00 €

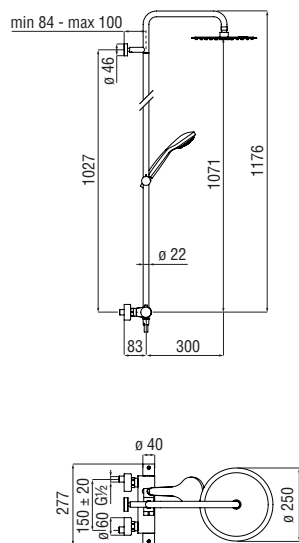

RAEK219/4CR  
43,00 € - 5 pz.

**Termostatico esterno con rampa tagliabile**

- Blocco di sicurezza 38° C
- Valvole antiritorno
- Soffione a snodo  $\varnothing$  250 mm abs
- Supporto doccetta scorrevole e orientabile
- Doccetta monogetto e flessibile 150 cm
- Compatibile con mensola AV00141/5
- Filtri di ricambio cartuccia inclusi nella confezione

Cromo lucido TG85430/20CR **NEW** 524,00 €



RCR201/5  
58,00 €

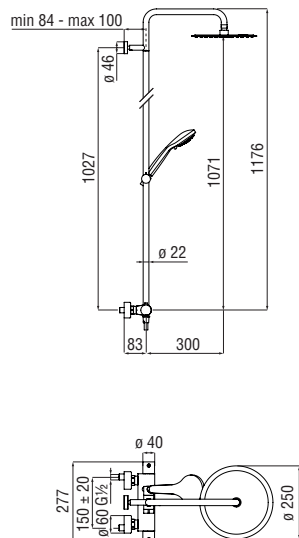

RCR201/70  
39,00 €

**Termostatico esterno con rampa tagliabile**

- Blocco di sicurezza 38° C
- Valvole antiritorno
- Soffione a snodo  $\varnothing$  250 mm abs
- Supporto doccetta scorrevole e orientabile
- Doccetta a 3 getti e flessibile 150 cm
- Compatibile con mensola AV00141/5
- Filtri di ricambio cartuccia inclusi nella confezione

Nota: rampa in finitura Mora opaco non tagliabile

Cromo lucido TG85430/21CR **NEW** 545,00 €

Mora opaco TG85430/21BM **NEW** 818,00 €



RCR201/5  
58,00 €

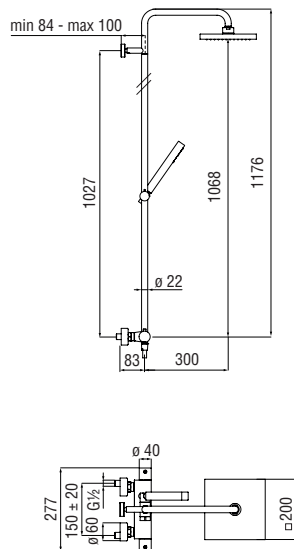

RCR201/70  
39,00 €

**Termostatico esterno con rampa tagliabile**

- Blocco di sicurezza 38° C
- Valvole antiritorno
- Soffione a snodo 200 x 200 mm
- Sistema anticalcare
- Supporto doccetta scorrevole e orientabile
- Doccetta monogetto e flessibile 150 cm
- Compatibile con mensola AV00141/5
- Filtri di ricambio cartuccia inclusi nella confezione

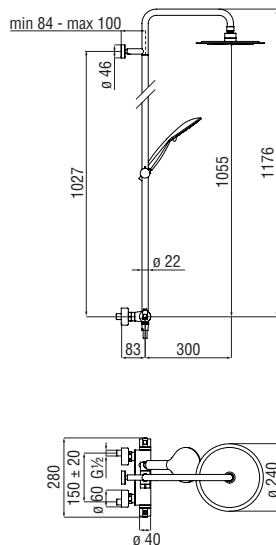
Cromo lucido TG85430/22CR **NEW** 555,00 €RCR201/5  
58,00 €RCR201/70  
39,00 €**Termostatico esterno con rampa tagliabile**

- Blocco di sicurezza 38° C
- Valvole antiritorno
- Soffione a snodo ø 240 mm
- Supporto doccetta scorrevole e orientabile
- Doccetta a 2 getti e flessibile 150 cm
- Compatibile con mensola AV00141/5
- Filtri di ricambio cartuccia inclusi nella confezione

Cromo lucido TY85430/23CR **NEW** 498,00 €RCR201/5  
58,00 €RCR201/70  
39,00 €

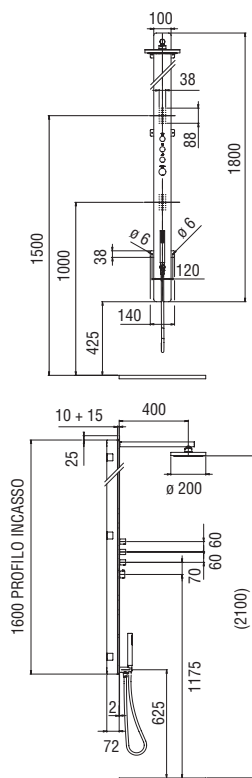

**Termostatico incasso multifunzione**

- Blocco di sicurezza 38° C
- Soffione a snodo ø 200 mm
- Sistema anticalcare
- Bodyjet getto pioggia
- Supporto doccetta fisso
- Doccetta monogetto e flessibile 150 cm

Cromo lucido WE72200/10CR 3.990,00 €

 RCR201/56  
58,00 €

 RVT200/5D  
18,00 €

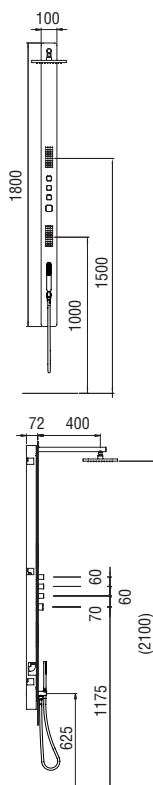

**Termostatico incasso multifunzione**

- Blocco di sicurezza 38° C
- Soffione a snodo 220 x 220 mm abs
- Bodyjet getto pioggia
- Supporto doccetta fisso
- Doccetta monogetto e flessibile 150 cm

Cromo lucido LP90000/50CR **MOD** 4.329,00 €

 RCR201/56  
58,00 €

 RVT200/5D  
18,00 €



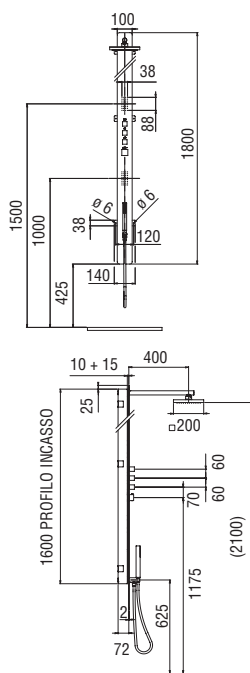

**Termostatico incasso multifunzione**

- Blocco di sicurezza 38° C
- Soffione a snodo 200 x 200 mm
- Sistema anticalcare
- Bodyjet getto pioggia
- Supporto doccetta fisso
- Doccetta monogetto e flessibile 150 cm

Cromo lucido WE72200/20CR 4.164,00 €



RCR201/56  
58,00 €



RVT200/5D  
18,00 €

**ACCESSORI**

**Mensola porta oggetti (Abs)**

- Amovibile
- Per colonne termostatiche compatibili

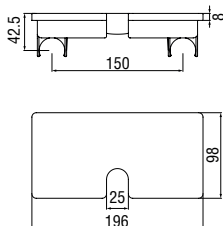

- AVO0141/5 36,00 €



COLONNE DOCCIA

# COLONNE MONOCOMANDO

Centro Stile Nobili

Una pausa quotidiana di puro benessere che supera la semplice necessità: le colonne doccia con miscelazione monocomando (all'interno della gamma sono presenti anche alcune colonne con miscelazione bicomando) dotate di cartuccia Nobili Widd® garantita 20 anni offrono la più avanzata tecnologia e affidabilità, per garantire ogni giorno un relax totale e sincero.

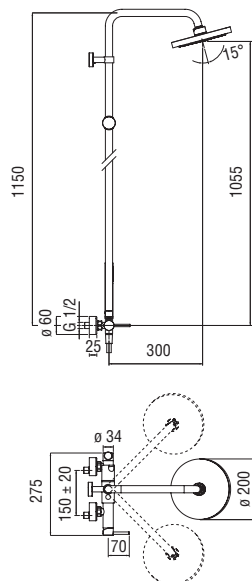
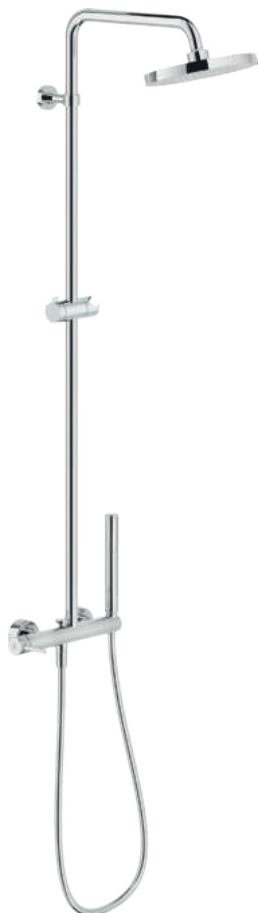

**Monocomando esterno**

- Limitatore di portata con freno al 50%
- Soffione a snodo  $\varnothing$  200 mm abs
- Sistema anticalcare
- Deviatore con ritorno automatico
- Supporto doccetta scorrevole e orientabile
- Doccetta monogetto e flessibile 150 cm

Cromo lucido AQ93130/30CR 669,00 €



CARTRIDGE  
WARRANTY

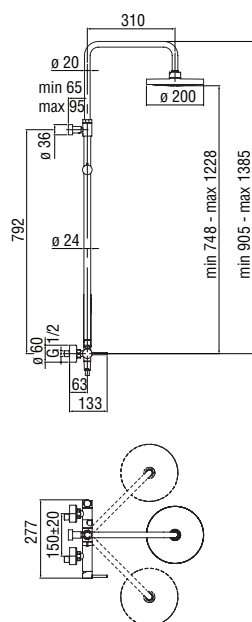
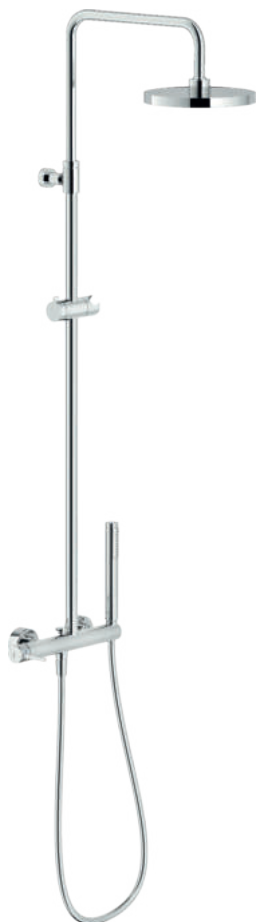

RCR280/D  
39,00 €

**Monocomando esterno con rampa telescopica**

- Limitatore di portata con freno al 50%
- Soffione a snodo  $\varnothing$  200 mm abs
- Sistema anticalcare
- Deviatore con ritorno automatico
- Supporto doccetta scorrevole e orientabile
- Doccetta monogetto e flessibile 150 cm

Cromo lucido AQ93130/50CR 916,00 €

Inox spazzolato AQ93130/50IX 1.371,00 €

Mora opaco AQ93130/50BM **NEW** 1.371,00 €



CARTRIDGE  
WARRANTY



RCR280/D  
39,00 €

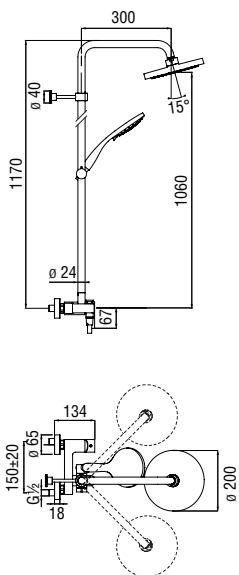

**Monocomando esterno**

- Limitatore di portata con freno al 50%
- Soffione a snodo  $\varnothing$  200 mm abs
- Deviatore con ritorno automatico
- Supporto doccetta scorrevole e orientabile
- Doccetta a 3 getti e flessibile 150 cm

Cromo lucido	LR116130/30CR	<b>MOD</b>	797,00 €
Mora opaco	LR116130/30BM	<b>MOD</b>	1.197,00 €



CARTRIDGE  
WARRANTY



RCR350/D  
39,00 €

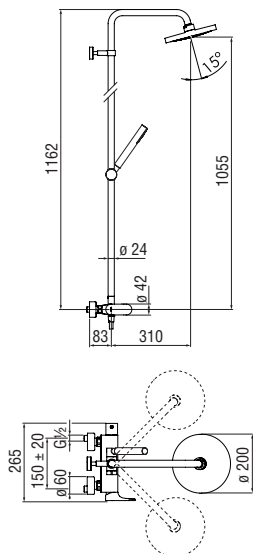

**Monocomando esterno**

- Limitatore di portata con freno al 50%
- Soffione a snodo  $\varnothing$  200 mm abs
- Sistema anticalcare
- Supporto doccetta scorrevole e orientabile
- Doccetta monogetto e flessibile 150 cm

Cromo lucido	YO126130/30CR	717,00 €
Mora opaco	YO126130/30BM	1.075,00 €



CARTRIDGE  
WARRANTY



RCR350  
39,00 €

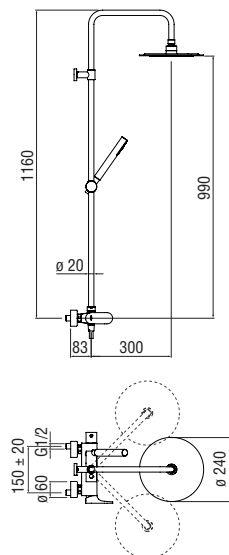

RCR201/70SC  
39,00 €

**Monocomando esterno**

- Limitatore di portata con freno al 50%
- Soffione a snodo  $\varnothing$  240 mm
- Sistema anticalcare
- Supporto doccetta scorrevole e orientabile
- Doccetta monogetto e flessibile 150 cm

Cromo lucido

YO126130/60CR

827,00 €

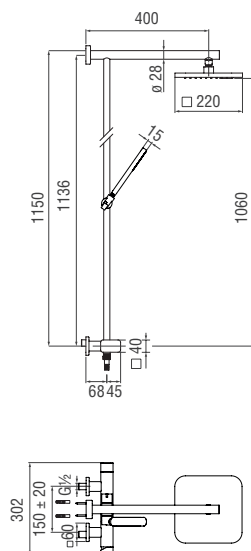
CARTRIDGE  
WARRANTYRCR350  
39,00 €RCR201/70SC  
39,00 €**Monocomando esterno**

- Limitatore di portata con freno al 50%
- Soffione a snodo 220 x 220 mm abs
- Rampa tagliabile
- Supporto doccetta scorrevole e orientabile
- Doccetta monogetto e flessibile 150 cm

Cromo lucido

LP90130/30CR

**MOD**

1.611,00 €

CARTRIDGE  
WARRANTYRCR350  
39,00 €RCR201/59  
51,00 €

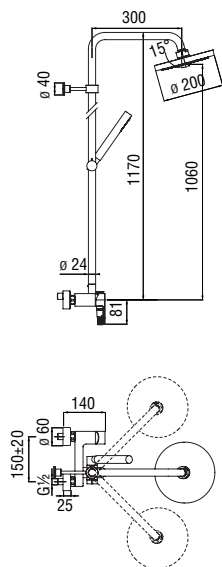
**Monocomando esterno**

- Limitatore di portata con freno al 50%
- Soffione a snodo  $\varnothing$  200 mm abs
- Deviatore con ritorno automatico
- Supporto doccetta scorrevole e orientabile
- Doccetta monogetto e flessibile 150 cm

Cromo lucido	UP94130/30CR	773,00 €
Mora opaco	UP94130/30BM	1.160,00 €



CARTRIDGE  
WARRANTY

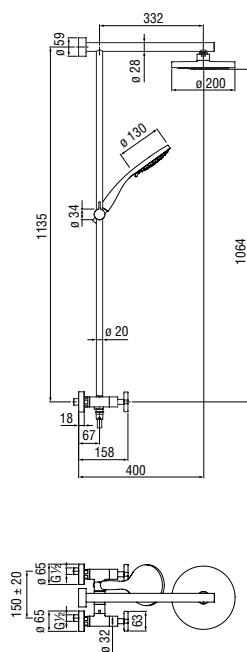

RCR350/D  
39,00 €

**Gruppo esterno**

- Soffione a snodo  $\varnothing$  200 mm abs
- Deviatore con ritorno automatico
- Supporto doccetta scorrevole e orientabile
- Doccetta a 3 getti e flessibile 150 cm

Cromo lucido	LR116230/30CR	<b>MOD</b>	1.043,00 €
Mora opaco	LR116230/30BM	<b>MOD</b>	1.566,00 €



RVT200/26  
18,00 €

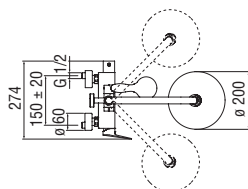
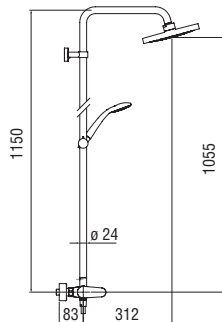

**Monocomando esterno**

- Limitatore di portata con freno al 50%
- Soffione a snodo ø 200 mm abs
- Sistema anticalcare
- Supporto doccetta scorrevole e orientabile
- Doccetta monogetto e flessibile 150 cm

Cromo lucido BS101130/30CR 588,00 €



CARTRIDGE WARRANTY



RCR350 39,00 €



RCR201/70SC 39,00 €

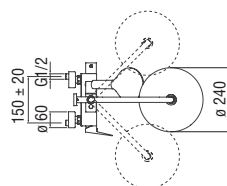
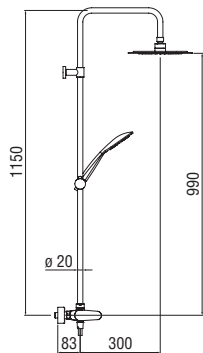

**Monocomando esterno**

- Limitatore di portata con freno al 50%
- Soffione a snodo ø 240 mm
- Sistema anticalcare
- Supporto doccetta scorrevole e orientabile
- Doccetta monogetto e flessibile 150 cm

Cromo lucido BS101130/60CR 489,00 €



CARTRIDGE WARRANTY



RCR350 39,00 €



RCR201/70SC 39,00 €



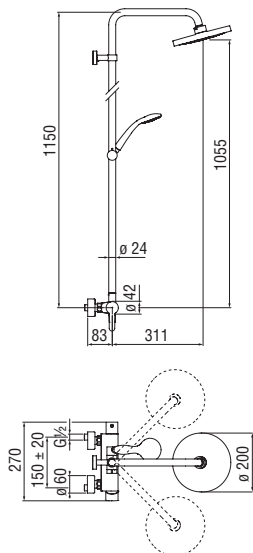

**Monocomando esterno**

- Limitatore di portata con freno al 50%
- Soffione a snodo ø 200 mm abs
- Sistema anticalcare
- Supporto doccetta scorrevole e orientabile
- Doccetta monogetto e flessibile 150 cm

Cromo lucido	AB87130/30CR	588,00 €
Mora opaco	AB87130/30BM	<b>NEW</b> 794,00 €

CARTRIDGE WARRANTY	RCR350 39,00 €	RCR201/70SC 39,00 €

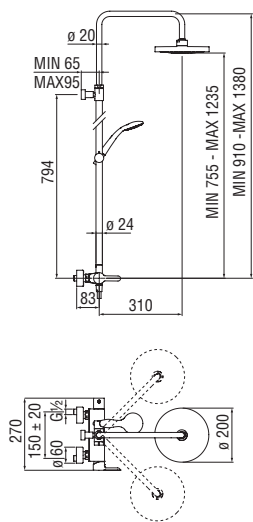

**Monocomando esterno con rampa telescopica**

- Limitatore di portata con freno al 50%
- Soffione a snodo ø 200 mm abs
- Sistema anticalcare
- Supporto doccetta scorrevole e orientabile
- Doccetta monogetto e flessibile 150 cm

Cromo lucido	AB87130/50CR	834,00 €
Mora opaco	AB87130/50BM	<b>NEW</b> 1.126,00 €

CARTRIDGE WARRANTY	RCR350 39,00 €	RCR201/70SC 39,00 €

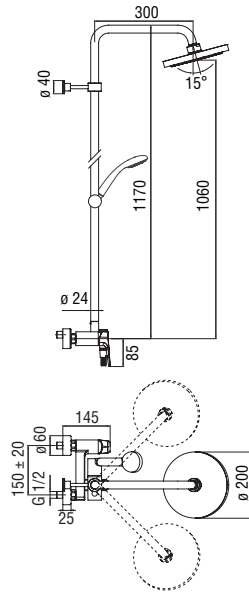
**Monocomando esterno**

- Limitatore di portata con freno al 50%
- Soffione a snodo ø 200 mm abs
- Sistema anticalcare
- Deviatore con ritorno automatico
- Supporto doccetta scorrevole e orientabile
- Doccetta monogetto e flessibile 150 cm

Cromo lucido

NB84130/30CR

770,00 €

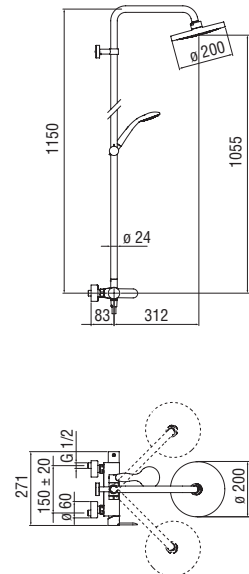
CARTRIDGE  
WARRANTYRCR350/D  
39,00 €**Monocomando esterno**

- Limitatore di portata con freno al 50%
- Soffione a snodo ø 200 mm abs
- Sistema anticalcare
- Supporto doccetta scorrevole e orientabile
- Doccetta monogetto e flessibile 150 cm

Cromo lucido

SA99130/30CR

770,00 €

CARTRIDGE  
WARRANTYRCR350  
39,00 €RCR201/70SC  
39,00 €

**Monocomando esterno con rampa telescopica**

- Limitatore di portata con freno al 50%
- Soffione a snodo 360 x 200 mm
- Sistema anticalcare
- Supporto doccetta scorrevole e orientabile
- Doccetta a 3 getti e flessibile 150 cm

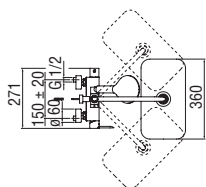
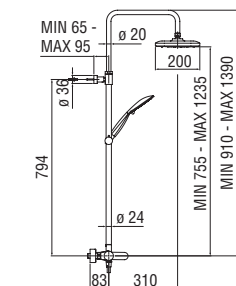

Cromo lucido

SA99130/51CR

995,00 €

CARTRIDGE  
WARRANTYRCR350  
39,00 €RCR201/70SC  
39,00 €**Monocomando esterno con rampa telescopica**

- Limitatore di portata con freno al 50%
- Soffione a snodo ø 250 mm spessore 2 mm
- Supporto doccetta scorrevole e orientabile
- Doccetta a 3 getti e flessibile 150 cm

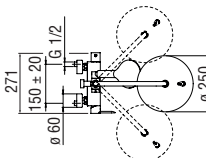
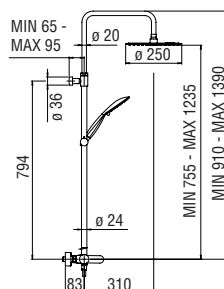

Cromo lucido

SA99130/52CR

524,00 €

CARTRIDGE  
WARRANTYRCR350  
39,00 €RCR201/70SC  
39,00 €

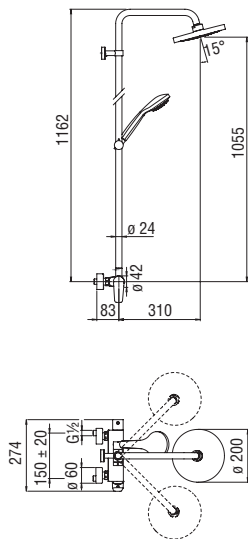

**Monocomando esterno**

- Limitatore di portata con freno al 50%
- Soffione a snodo ø 200 mm abs
- Sistema anticalcare
- Supporto doccetta scorrevole e orientabile
- Doccetta monogetto e flessibile 150 cm

Cromo lucido SY97130/30CR 770,00 €



CARTRIDGE  
WARRANTY



RCR350  
39,00 €



RCR201/70SC  
39,00 €

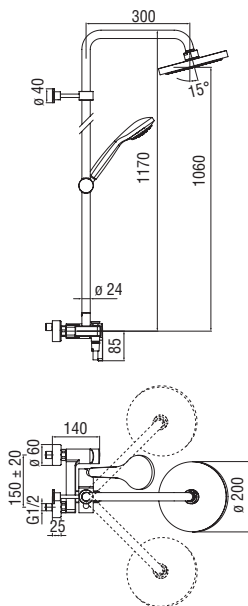

**Monocomando esterno**

- Limitatore di portata con freno al 50%
- Soffione a snodo ø 200 mm abs
- Sistema anticalcare
- Deviatore con ritorno automatico
- Supporto doccetta scorrevole e orientabile
- Doccetta monogetto e flessibile 150 cm

Cromo lucido RD00130/30CR 770,00 €



CARTRIDGE  
WARRANTY



RCR350/D  
39,00 €

COLONNE DOCCIA

# COLONNE RENOVA

Centro Stile Nobili

Dedicate al rinnovamento dell'ambiente doccia senza interventi di muratura, le colonne Renova permettono di sostituire in modo semplice e veloce la singola uscita (saliscendi o soffione) con un impianto a due vie. Il deviatore incorporato consente di scegliere tra soffione e doccetta, mentre la rampa telescopica la rende adattabile a qualsiasi ambiente.



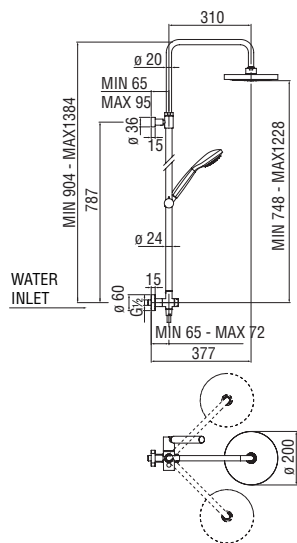

**Colonna con presa acqua e rampa telescopica**

- Presa acqua ø 1/2"
- Soffione a snodo ø 200 mm abs
- Sistema anticalcare
- Supporto doccetta scorrevole e orientabile
- Doccetta monogetto e flessibile 150 cm

Cromo lucido WE00141/4OCR 465,00 €

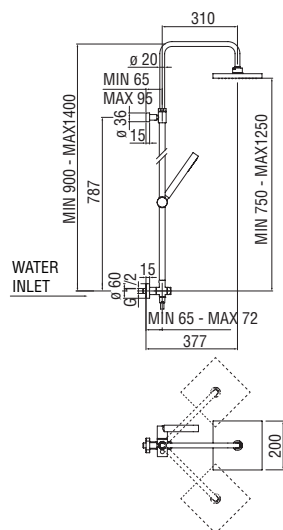

**Colonna con presa acqua e rampa telescopica**

- Presa acqua ø 1/2"
- Soffione a snodo 200 x 200 mm abs
- Sistema anticalcare
- Supporto doccetta scorrevole e orientabile
- Doccetta monogetto e flessibile 150 cm

Cromo lucido WE00141/5OCR 531,00 €

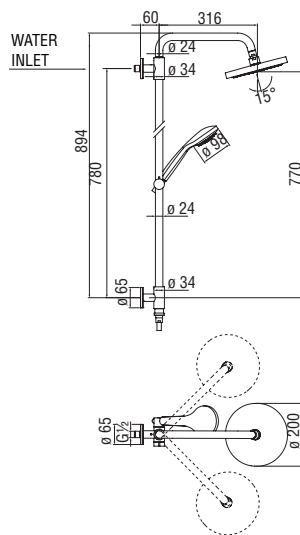

**Colonna con presa acqua al soffione**

- Presa acqua  $\varnothing 1/2''$
- Soffione a snodo  $\varnothing 200$  mm abs
- Sistema anticalcare
- Supporto doccetta scorrevole e orientabile
- Doccetta monogetto e flessibile 150 cm

Cromo lucido WE00141/70CR 597,00 €

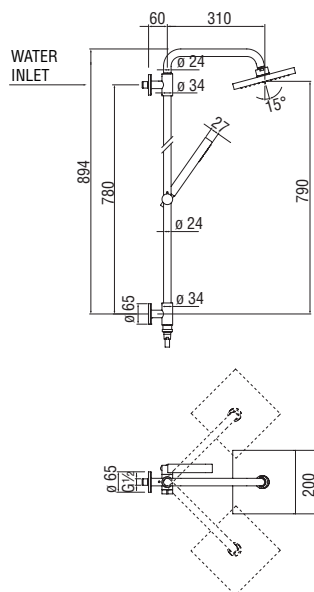

**Colonna con presa acqua al soffione**

- Presa acqua  $\varnothing 1/2''$
- Soffione a snodo 200 x 200 mm abs
- Sistema anticalcare
- Supporto doccetta scorrevole e orientabile
- Doccetta monogetto e flessibile 150 cm

Cromo lucido WE00141/75CR 664,00 €

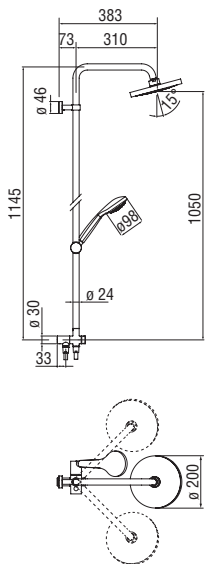

**Colonna con flessibile di raccordo**

- Soffione a snodo  $\varnothing$  200 mm abs
- Sistema anticalcare
- Supporto doccetta scorrevole e orientabile
- Doccetta monogetto e flessibile 150 cm

Cromo lucido WE00141/90CR 438,00 €

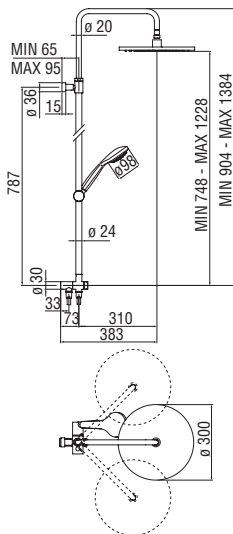

**Colonna con flessibile di raccordo e rampa telescopica**

- Soffione a snodo  $\varnothing$  300 mm abs
- Sistema anticalcare
- Supporto doccetta scorrevole e orientabile
- Doccetta monogetto e flessibile 150 cm

Cromo lucido WE00141/82CR 677,00 €



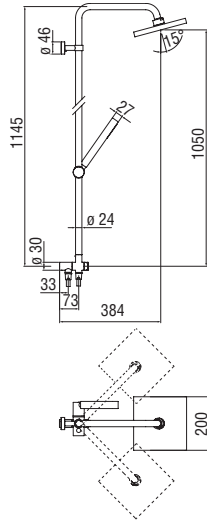

**Colonna con flessibile di raccordo**

- Soffione a snodo 200 x 200 mm abs
- Sistema anticalcare
- Supporto doccetta scorrevole e orientabile
- Doccetta monogetto e flessibile 150 cm

Cromo lucido WE00141/95CR 505,00 €

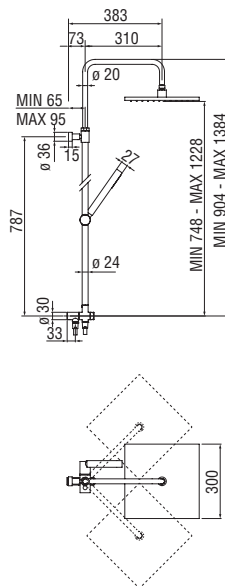

**Colonna con flessibile di raccordo e rampa telescopica**

- Soffione a snodo 300 x 300 mm abs
- Sistema anticalcare
- Supporto doccetta scorrevole e orientabile
- Doccetta monogetto e flessibile 150 cm

Cromo lucido WE00141/85CR 685,00 €



DOCCIA

# SET DOCCIA COMPLETI

Centro Stile Nobili

Numerose composizioni (con impianto monocomando o termostatico, a 1 o 2 vie) nate con l'obiettivo di semplificare e velocizzare la scelta nel vasto universo di proposte doccia. Ogni componente all'interno del set è dettato da un'attenta progettazione, volta a massimizzare il piacere finale.



**Monocomando incasso a 2 vie**

- Limitatore di portata con freno al 50%
- Deviatore a 2 vie
- Supporto doccetta fisso rivestito in Teflon
- Doccetta monogetto e flessibile 150 cm
- Braccio a parete 350 mm
- Soffione a snodo ø 200 mm abs
- Parte esterna e parte incasso

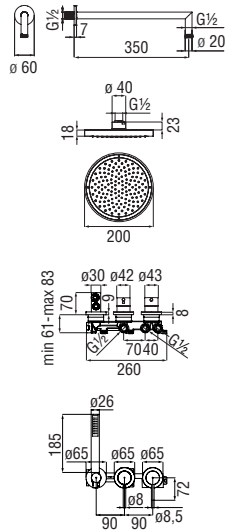

Cromo lucido WESK100/91TCR 1.088,00 €

CARTRIDGE WARRANTY	RCR350 39,00 €	RCR201/35FSC 39,00 €	NR00212/22CR 85,00 €

SET DOCCIA COMPLETI

**Monocomando incasso a 2 vie**

- Limitatore di portata con freno al 50%
- Deviatore a 2 vie
- Supporto doccetta scorrevole e orientabile
- Doccetta monogetto e flessibile 150 cm
- Braccio a parete 350 mm
- Soffione a snodo ø 200 mm abs
- Parte esterna e parte incasso

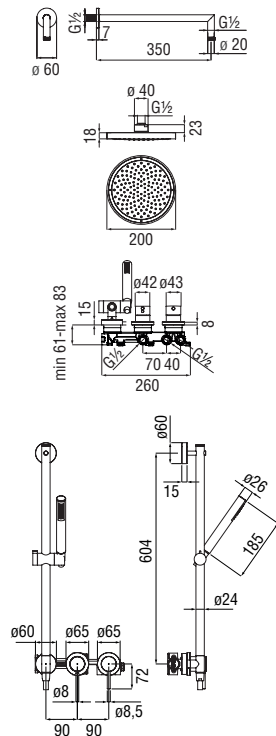

Cromo lucido WESK100/92TCR 1.227,00 €

CARTRIDGE WARRANTY	RCR350 39,00 €	RCR201/35FSC 39,00 €	NR00212/22CR 85,00 €

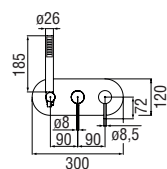
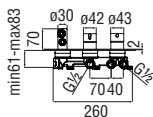
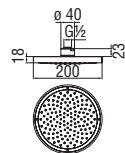
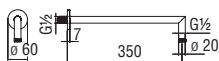
**Monocomando incasso a 2 vie**

- Limitatore di portata con freno al 50%
- Deviatore a 2 vie
- Supporto doccetta fisso rivestito in Teflon
- Doccetta monogetto e flessibile 150 cm
- Braccio a parete 350 mm
- Soffione a snodo  $\varnothing$  200 mm abs
- Parte esterna e parte incasso

Cromo lucido

WESK100/90TCR

1.088,00 €

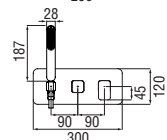
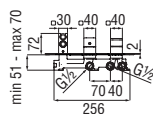
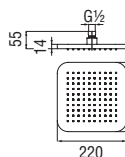
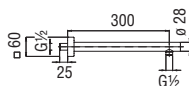
CARTRIDGE  
WARRANTYRCR350  
39,00 €RCR201/35FSC  
39,00 €NR00212/22CR  
85,00 €**Monocomando incasso a 2 vie**

- Limitatore di portata con freno al 50%
- Deviatore a 2 vie
- Supporto doccetta fisso
- Doccetta monogetto e flessibile 150 cm
- Braccio a parete 300 mm
- Soffione a snodo 220 x 220 mm abs
- Parte esterna e parte incasso

Cromo lucido

WESK100/90LPCR

**MOD**

1.490,00 €

CARTRIDGE  
WARRANTYRCR350  
39,00 €RCR201/35FSC  
39,00 €NR00212/24CR  
158,00 €

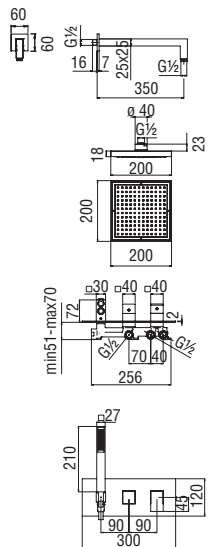

**Monocomando incasso a 2 vie**

- Limitatore di portata con freno al 50%
- Deviatore a 2 vie
- Supporto doccetta fisso
- Doccetta monogetto e flessibile 150 cm
- Braccio a parete 350 mm
- Soffione a snodo 200 x 200 mm abs
- Parte esterna e parte incasso

Cromo lucido WESK100/90QCR 1.477,00 €

CARTRIDGE WARRANTY	RCR350 39,00 €	RCR201/35FSC 39,00 €	NR00212/23CR 177,00 €

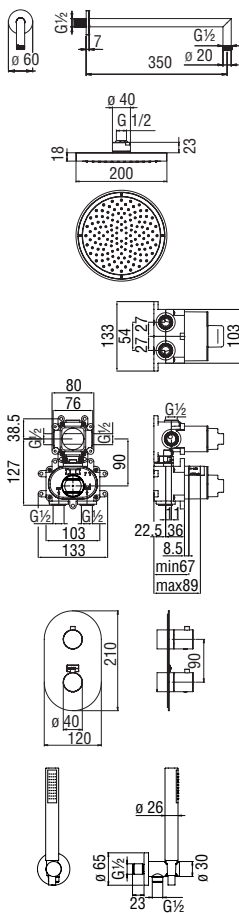

**Termostatico incasso a 2 vie**

- Blocco di sicurezza 38° C
- Rubinetti di chiusura
- Uscite ø 1/2"
- Valvole antiritorno
- Profondità incasso 70 mm
- Possibilità di regolazione (± 25 mm)
- Braccio a parete 350 mm
- Soffione a snodo ø 200 mm abs
- Presa acqua ø 1/2"
- Supporto doccetta fisso rivestito in Teflon
- Doccetta monogetto e flessibile 150 cm
- Parte esterna e parte incasso
- Filtri di ricambio cartuccia inclusi nella confezione

Cromo lucido WESK102/TCR 1.067,00 €

RCR201/5 58,00 €	RCR201/28 39,00 €	NR00008 34,00 €

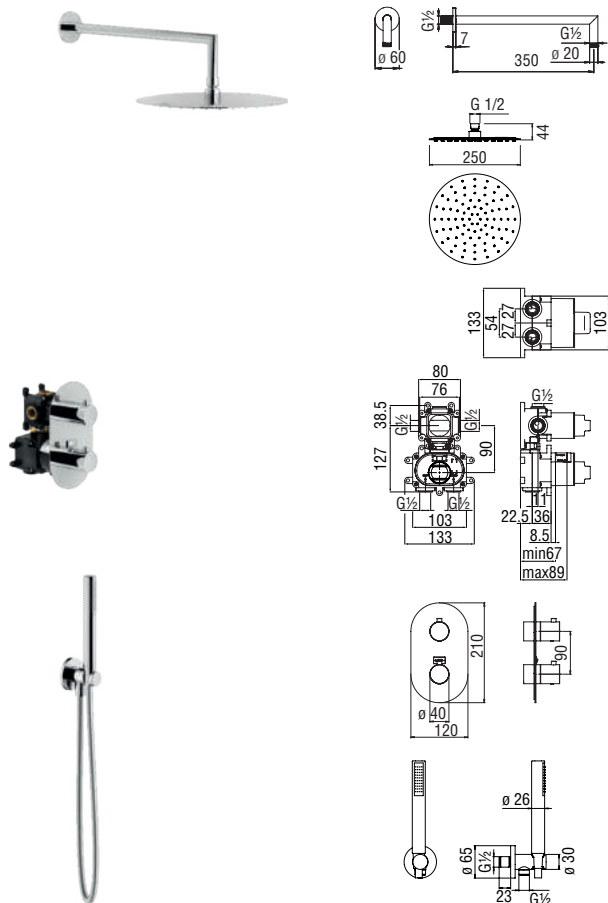

**Termostatico incasso a 2 vie**

- Blocco di sicurezza 38° C
- Rubinetti di chiusura
- Uscite ø 1/2"
- Valvole antiritorno
- Profondità incasso 70 mm
- Possibilità di regolazione (± 25 mm)
- Braccio a parete 350 mm
- Soffione a snodo ø 250 mm spessore 2 mm
- Presa acqua ø 1/2"
- Supporto doccetta fisso rivestito in Teflon
- Doccetta monogetto e flessibile 150 cm
- Parte esterna e parte incasso
- Filtri di ricambio cartuccia inclusi nella confezione

Cromo lucido	WESK102/ITCR	994,00 €
Mora opaco	WESK102/ITBM	1.481,00 €

 RCR201/5 58,00 €	 RCR201/28 39,00 €	 NR00008 34,00 €
---	--	--

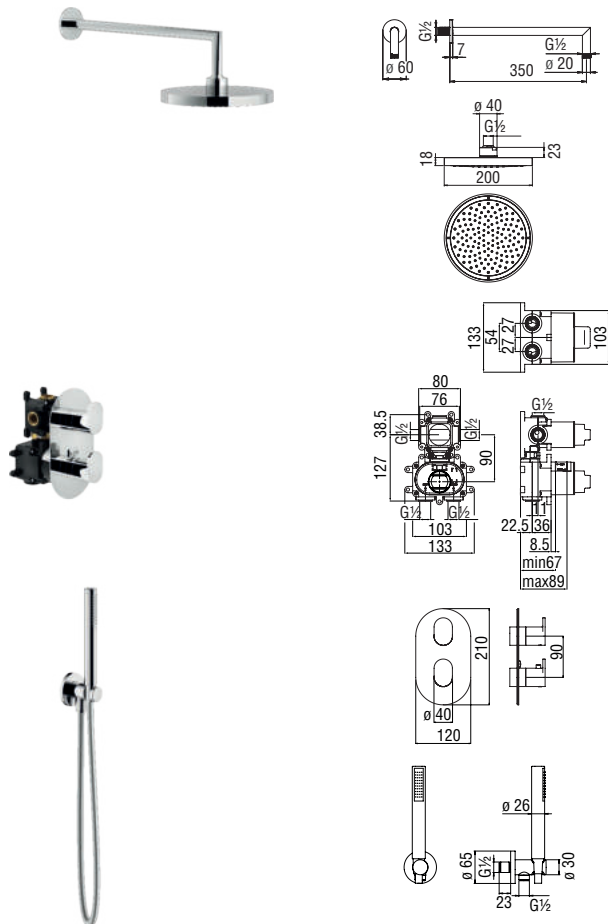

**Termostatico incasso a 2 vie**

- Blocco di sicurezza 38° C
- Rubinetti di chiusura
- Uscite ø 1/2"
- Valvole antiritorno
- Profondità incasso 70 mm
- Possibilità di regolazione (± 25 mm)
- Braccio a parete 350 mm
- Soffione a snodo ø 200 mm abs
- Presa acqua ø 1/2"
- Supporto doccetta fisso rivestito in Teflon
- Doccetta monogetto e flessibile 150 cm
- Parte esterna e parte incasso
- Filtri di ricambio cartuccia inclusi nella confezione

Cromo lucido	WESK102/UPCR	1.049,00 €
--------------	--------------	------------

 RCR201/5 58,00 €	 RCR201/28 39,00 €	 NR00008 34,00 €
---	--	--

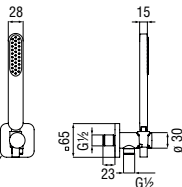
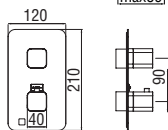
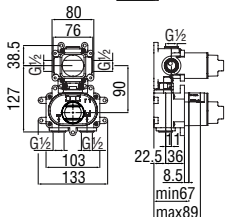
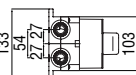
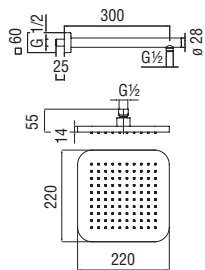

**Termostatico incasso a 2 vie**

- Blocco di sicurezza 38° C
- Rubinetti di chiusura
- Uscite ø 1/2"
- Valvole antiritorno
- Profondità incasso 70 mm
- Possibilità di regolazione (± 25 mm)
- Braccio a parete 300 mm
- Soffione a snodo 220 x 220 mm abs
- Presa acqua ø 1/2"
- Supporto doccetta fisso rivestito in Teflon
- Doccetta monogetto e flessibile 150 cm
- Parte esterna e parte incasso
- Filtri di ricambio cartuccia inclusi nella confezione



Cromo lucido WESK102/LPCR **MOD** 1.468,00 €

 RCR201/5  
58,00 €

 RCR201/28  
39,00 €

 NR00008  
34,00 €

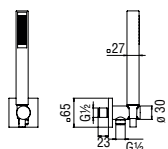
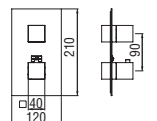
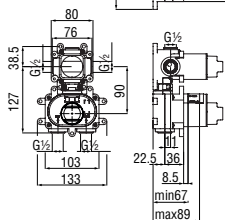
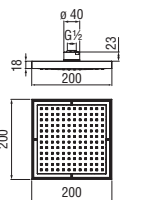
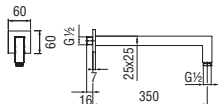

**Termostatico incasso a 2 vie**

- Blocco di sicurezza 38° C
- Rubinetti di chiusura
- Uscite ø 1/2"
- Valvole antiritorno
- Profondità incasso 70 mm
- Possibilità di regolazione (± 25 mm)
- Braccio a parete 350 mm
- Soffione a snodo 200 x 200 mm abs
- Presa acqua ø 1/2"
- Supporto doccetta fisso rivestito in Teflon
- Doccetta monogetto e flessibile 150 cm
- Parte esterna e parte incasso
- Filtri di ricambio cartuccia inclusi nella confezione



Cromo lucido WESK102/QCR 1.502,00 €

 RCR201/5  
58,00 €

 RCR201/28  
39,00 €

 NR00008  
34,00 €



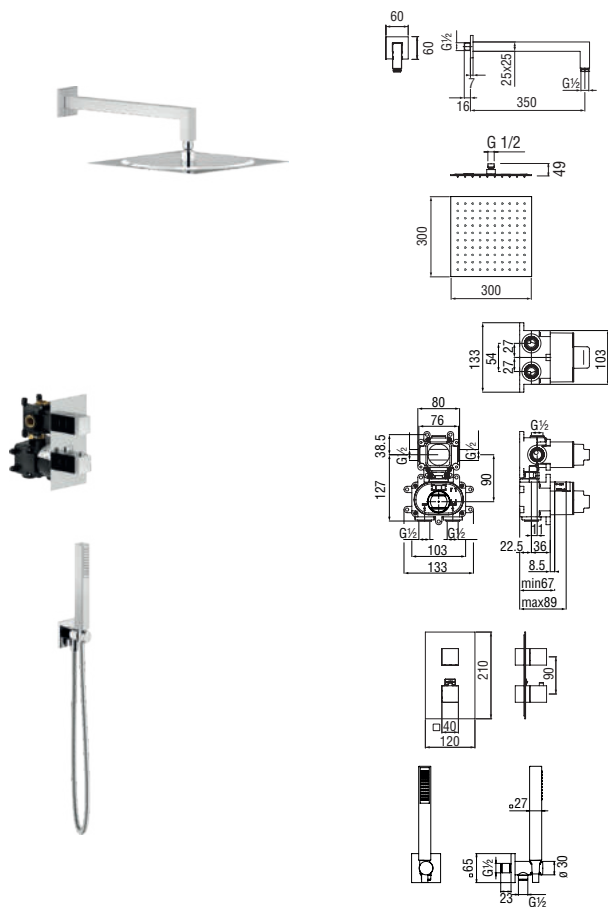

**Termostatico incasso a 2 vie**

- Blocco di sicurezza 38° C
- Rubinetti di chiusura
- Uscite ø 1/2"
- Valvole antiritorno
- Profondità incasso 70 mm
- Possibilità di regolazione (± 25 mm)
- Braccio a parete 350 mm
- Soffione a snodo 300 x 300 mm spessore 2 mm
- Presa acqua ø 1/2"
- Supporto doccetta fisso rivestito in Teflon
- Doccetta monogetto e flessibile 150 cm
- Parte esterna e parte incasso
- Filtri di ricambio cartuccia inclusi nella confezione

Cromo lucido	WESK102/1QCR	1.226,00 €
Mora opaco	WESK102/1QBM	1.839,00 €

 RCR201/5 58,00 €	 RCR201/28 39,00 €	 NR00008 34,00 €
---	--	--

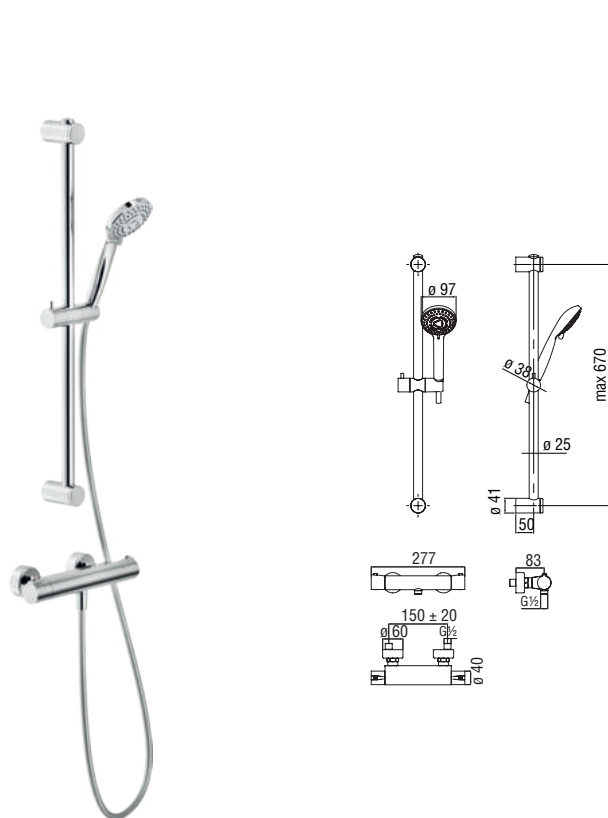

**Termostatico esterno a 1 via**

- Blocco di sicurezza 38° C
- Valvole antiritorno
- Sistema anticalcare
- Attacco regolabile
- Supporto doccetta scorrevole e orientabile
- Doccetta a 3 getti e flessibile 150 cm
- Filtri di ricambio cartuccia inclusi nella confezione

Cromo lucido	WESK030/SYCR	320,00 €
--------------	--------------	----------

 RCR201/6 58,00 €	 RVT200/26 18,00 €
---	--



## CUCINA

Dedichiamo a questo settore un grande impegno, sia per quanto concerne le valenze estetiche che per la definizione degli aspetti funzionali, e mettiamo a disposizione della clientela, produttori di cucine, architetti e interior designer, una gamma pressochè infinita di soluzioni.



## SORGENTE

FILTRA		427
BOLLE <b>NEW</b>		431
FRIZZA <b>NEW</b>		435
FRIZZA & BOLLE <b>NEW</b>		439

## RUBINETTERIA NOBILI

LEVANTE		443
MOVE		443
HERON		443
LAMP		444
YPSILON		444
FLAT		444
MASTER		444
MANIA		445
POP		446
WEB		447
FLAG		448
FLAG 316		450
GIORNO		451
VELIS		451
LIKID		452
LIVE		452
ACQUERELLI		455
LOOP		457
ACQUAVIVA		457
UP		457
MIA		458
SOFI		458
CHARLIE		458
LIRA		459
CARLOS PRIMERO		459
GRAZIA		460
ANTICA		460
MATCH		463

## RUBINETTERIA ENNE DI NOBILI

SNOW		467
BILLY		468
OZ T5		468
CUCI		468
RING		469
OVETTO		469

BLUES		470
ABC		471
NOBI		471
SAND		471
SKY		472
NEW ROAD		472
NEW ROAD T7		473

## SPECIALI

INDUSTRIALI		475
SIDE SPRAY		475
A SCOMPARSA		475
SOTTOFINESTRA		476
BASSA PRESSIONE		478
LAVASTOVIGLIE		478
A PARETE		479

## ACCESSORI

DISPENSER SAPONE		481
------------------	--	-----

SORGENTE

# FILTRA

Centro Stile Nobili

Sorgente Filtra trasforma l'acqua della comune rete idrica in acqua purificata, dal sapore fresco e naturale: vengono trattenute eventuali sostanze che ne alterano il sapore, come cloro e metalli pesanti (rame, piombo o nichel) e l'acqua è arricchita di Magnesio e Zinco grazie al filtro sviluppato in collaborazione con BWT, leader mondiale nel settore delle tecnologie di trattamento dell'acqua.



Cromo lucido



Inox spazzolato



Grafite spazzolato PVD



Mora opaco



Ambra spazzolato PVD



Argilla spazzolato PVD

**Bicomando con sistema filtrante**

- Limitatore di portata con freno al 50%
- Bocca girevole 360°
- Aeratore anticalcare M 22 x 1, aeratore acqua filtrata
- Filtro AQA drink Zinc + Magnesium BWT 650 lt (22 °f)
- Contaltri per controllo capacità filtro (batterie non incluse)
- Flessibili inox ø 3/8"

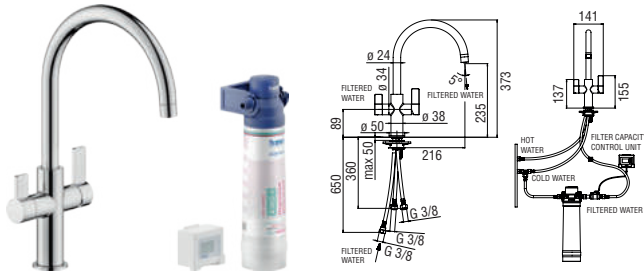

Cromo lucido	FL96824/3VBCR	<b>MOD</b>	540,00 €
Grafite spazzolato PVD	FL96824/3VBGUP	<b>MOD</b>	740,00 €
Mora opaco	FL96824/3VBBM	<b>MOD</b>	650,00 €
Ambra spazzolato PVD	FL96824/3VBGTP	<b>MOD</b>	740,00 €
Argilla spazzolato PVD	FL96824/3VBRTPT	<b>MOD</b>	740,00 €

<b>20 YEARS</b> CARTRIDGE WARRANTY	RCR280/D 39,00 €	RVT200/5S 18,00 €	RAEK219/38CR 100,00 € - 10 pz.
---------------------------------------	---------------------	----------------------	-----------------------------------

**Bicomando con sistema filtrante**

- Limitatore di portata con freno al 50%
- Bocca girevole 360°
- Aeratore anticalcare M 18 x 1, aeratore acqua filtrata
- Filtro AQA drink Zinc + Magnesium BWT 650 lt (22 °f)
- Contaltri per controllo capacità filtro (batterie non incluse)
- Flessibili inox ø 3/8"

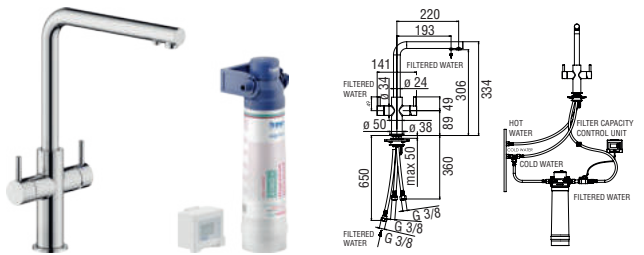

Cromo lucido	AQ93823/3VBCR	<b>MOD</b>	610,00 €
Grafite spazzolato PVD	AQ93823/3VBGUP	<b>MOD</b>	810,00 €
Mora opaco	AQ93823/3VBBM	<b>MOD</b>	720,00 €
Ambra spazzolato PVD	AQ93823/3VBGTP	<b>MOD</b>	810,00 €
Argilla spazzolato PVD	AQ93823/3VBRTPT	<b>MOD</b>	810,00 €

<b>20 YEARS</b> CARTRIDGE WARRANTY	RCR280/D 39,00 €	RVT200/5S 18,00 €	RAEK220/27CR 43,00 € - 10 pz.
---------------------------------------	---------------------	----------------------	----------------------------------

**Bicomando con sistema filtrante**

- Limitatore di portata con freno al 50%
- Bocca girevole 180° (adattabile 120° o 360°)
- Aeratore anticalcare M 22 x 1, aeratore acqua filtrata
- Filtro AQA drink Zinc + Magnesium BWT 650 lt (22 °f)
- Contaltri per controllo capacità filtro (batterie non incluse)
- Flessibili inox ø 3/8"

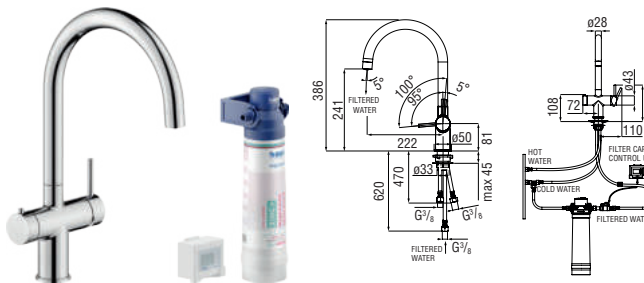

Cromo lucido	LV129133/3VBCR	<b>NEW</b>	610,00 €
Inox spazzolato	LV129133/3VBIX	<b>NEW</b>	720,00 €
Mora opaco	LV129133/3VBBM	<b>NEW</b>	720,00 €

<b>20 YEARS</b> CARTRIDGE WARRANTY	RCR350 39,00 €	RVT200/5S 18,00 €	RAE219/77CR 60,00 € - 10 pz.
---------------------------------------	-------------------	----------------------	---------------------------------

**Bicomando con sistema filtrante**

- Limitatore di portata con freno al 50%
- Bocca girevole 180° (adattabile 120° o 360°)
- Doccetta Dual Flow estraibile
- Filtro AQA drink Zinc + Magnesium BWT 650 lt (22 °f)
- Contaltri per controllo capacità filtro (batterie non incluse)
- Flessibili inox ø 3/8"



Cromo lucido	LV129117/3VBCR	<b>NEW</b>	740,00 €
Inox spazzolato	LV129117/3VBIX	<b>NEW</b>	840,00 €
Mora opaco	LV129117/3VBBM	<b>NEW</b>	840,00 €

<b>20 YEARS</b> CARTRIDGE WARRANTY	RCR350 39,00 €	RVT200/5S 18,00 €	
---------------------------------------	-------------------	----------------------	--

**Ricambio filtro AQA drink Zinc + Magnesium BWT tg. S**

· Capacità 650 lt (22 °f)

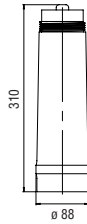

- RVR93095 **MOD** 103,00 €

**Ricambio filtro AQA drink Magnesium BWT tg. M**

· Capacità 3.330 lt (22 °f)

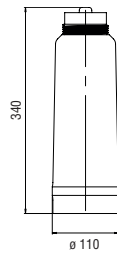

- RVR93095/M 159,00 €

**Ricambio staffa di supporto filtro**

· Compatibile con filtro tg. S, tg. M

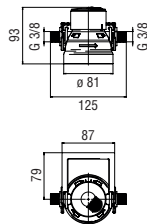

- RVR93094 100,00 €

**Ricambio contaltri per controllo capacità filtro**

· Batterie non incluse

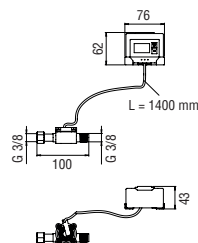

- RVR93096 90,00 €

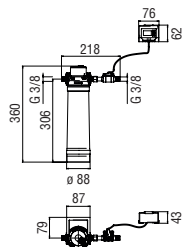
**Kit ricambio completo**

- Filtro AQA drink Zinc + Magnesium BWT 650 lt (22 °f)
- Staffa di supporto filtro
- Contaltri per controllo capacità filtro (batterie non incluse)

RKTBWT/FIL

**MOD**

253,00 €



SORGENTE

# BOLLE

Centro Stile Nobili

Sorgente Bolle eroga acqua corrente miscelata e acqua bollente istantanea a 99 °C, risparmiando tempo in tutte le attività di cucina che richiedono acqua a questa temperatura. Il boiler ad alta efficienza è abbinato al filtro Gioia: migliora la qualità dell'acqua mantenendo un corretto equilibrio minerale e riduce l'eventuale presenza di metalli pesanti altamente dannosi per l'organismo.



**Bicomando meccanico con sistema boiler 4 lt pressurizzato**

- Limitatore di portata con freno al 50%
- Bocca girevole 180° (adattabile 120° o 360°)
- Aeratore anticalcare M 22 x 1
- Flessibili inox ø 3/8"
- Sistema di sicurezza "Child-lock" brevettato
- Tecnologia brevettata "Cold Body"
- Canali di erogazione separati per acqua filtrata bollente
- Boiler elettronico 4 lt sottolavello in acciaio inox 316 L certificato CE
- Eroga acqua bollente istantanea a 99 °C (fino a 2,6 lt > 99 °C)
- Filtro a 5 fasi GIOIA (durata massima 1 anno oppure capacità media 1.700 lt a 18 °f @ bypass livello 6)
- Massima potenza 1650 W
- Voltaggio 230 V (50 Hz)
- Alimentazione Schuko EU
- Cavo di alimentazione 150 cm
- Massimo livello di rumorosità 15 dB

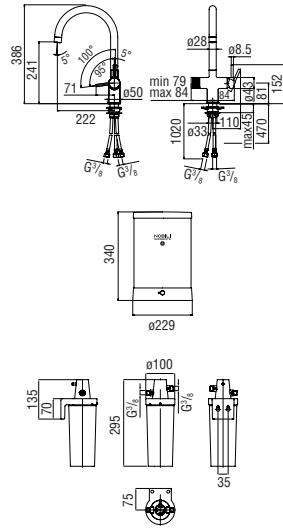

Nota: variante con presa UK disponibile con altro codice prodotto

Nota: prodotto non destinato a mercato francese

Nota: si consiglia l'acquisto del contaltri per controllo capacità filtro (opzionale)

Cromo lucido	LVOK133/HTCR	<b>NEW</b>	1.200,00 €
Inox spazzolato	LVOK133/HTIX	<b>NEW</b>	1.375,00 €
Mora opaco	LVOK133/HTBM	<b>NEW</b>	1.375,00 €



CARTRIDGE WARRANTY



RCR350 39,00 €



RAE219/76CR 60,00 € - 10 pz.

**Bicomando meccanico con sistema boiler 4 lt pressurizzato**

- Limitatore di portata con freno al 50%
- Bocca girevole 180° (adattabile 120° o 360°)
- Aeratore anticalcare M 22 x 1
- Flessibili inox ø 3/8"
- Sistema di sicurezza "Child-lock" brevettato
- Tecnologia brevettata "Cold Body"
- Canali di erogazione separati per acqua filtrata bollente
- Boiler elettronico 4 lt sottolavello in acciaio inox 316 L certificato CE
- Eroga acqua bollente istantanea a 99 °C (fino a 2,6 lt > 99 °C)
- Filtro a 5 fasi GIOIA (durata massima 1 anno oppure capacità media 1.700 lt a 18 °f @ bypass livello 6)
- Massima potenza 1650 W
- Voltaggio 230 V (50 Hz)
- Alimentazione Schuko EU
- Cavo di alimentazione 150 cm
- Massimo livello di rumorosità 15 dB

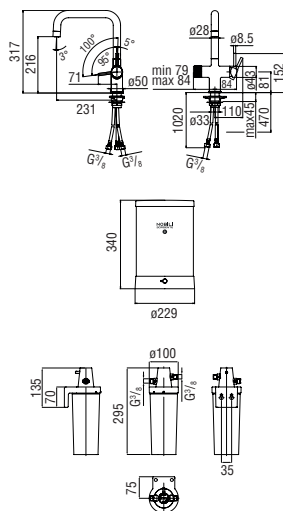

Nota: variante con presa UK disponibile con altro codice prodotto

Nota: prodotto non destinato a mercato francese

Nota: si consiglia l'acquisto del contaltri per controllo capacità filtro (opzionale)

Cromo lucido	LVOK123/HTCR	<b>NEW</b>	1.200,00 €
Inox spazzolato	LVOK123/HTIX	<b>NEW</b>	1.375,00 €
Mora opaco	LVOK123/HTBM	<b>NEW</b>	1.375,00 €



CARTRIDGE WARRANTY



RCR350 39,00 €



RAE219/76CR 60,00 € - 10 pz.

**Bicomando elettronico con sistema boiler 4 lt pressurizzato**

- Limitatore di portata con freno al 50%
- Bocca girevole 180° (adattabile 120° o 360°)
- Aeratore anticalcare M 22 x 1
- Flessibili inox ø 3/8"
- LED a colori per la selezione del tipo di acqua da erogare (acqua filtrata bollente)
- Canali di erogazione separati per acqua filtrata bollente
- Boiler elettronico 4 lt sottolavello in acciaio inox 316 L certificato CE
- Scatola elettronica di connessione inclusa
- Eroga acqua bollente istantanea a 99 °C (fino a 2,6 lt > 99 °C)
- Filtro a 5 fasi GIOIA (durata massima 1 anno oppure capacità media 1.700 lt a 18 °f @ bypass livello 6)
- Massima potenza 1650 W
- Voltaggio 230 V (50 Hz)
- Alimentazione Schuko EU
- Cavo di alimentazione 150 cm
- Massimo livello di rumorosità 15 dB

Nota: variante con presa UK disponibile con altro codice prodotto

Nota: prodotto non destinato a mercato francese

Nota: si consiglia l'acquisto del contaltri per controllo capacità filtro (opzionale)

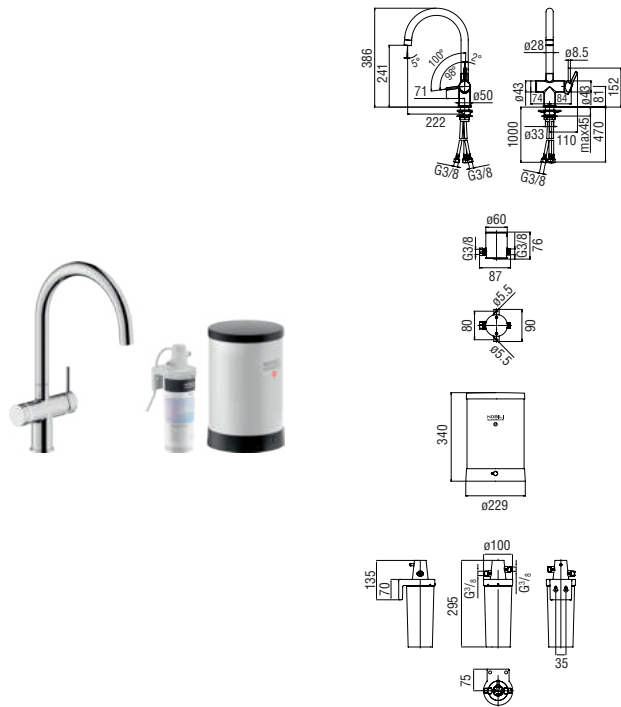

Cromo lucido	LVOK133/EHTCR	<b>NEW</b>	1.400,00 €
Inox spazzolato	LVOK133/EHTIX	<b>NEW</b>	1.575,00 €
Mora opaco	LVOK133/EHTBM	<b>NEW</b>	1.575,00 €
Ambra spazzolato PVD	LVOK133/EHTGTP	<b>NEW</b>	1.800,00 €



CARTRIDGE  
WARRANTY



RCR350  
39,00 €



RAE219/76CR  
60,00 € - 10 pz.

**Bicomando elettronico con sistema boiler 4 lt pressurizzato**

- Limitatore di portata con freno al 50%
- Bocca girevole 180° (adattabile 120° o 360°)
- Aeratore anticalcare M 22 x 1
- Flessibili inox ø 3/8"
- LED a colori per la selezione del tipo di acqua da erogare (acqua filtrata bollente)
- Canali di erogazione separati per acqua filtrata bollente
- Boiler elettronico 4 lt sottolavello in acciaio inox 316 L certificato CE
- Scatola elettronica di connessione inclusa
- Eroga acqua bollente istantanea a 99 °C (fino a 2,6 lt > 99 °C)
- Filtro a 5 fasi GIOIA (durata massima 1 anno oppure capacità media 1.700 lt a 18 °f @ bypass livello 6)
- Massima potenza 1650 W
- Voltaggio 230 V (50 Hz)
- Alimentazione Schuko EU
- Cavo di alimentazione 150 cm
- Massimo livello di rumorosità 15 dB

Nota: variante con presa UK disponibile con altro codice prodotto

Nota: prodotto non destinato a mercato francese

Nota: si consiglia l'acquisto del contaltri per controllo capacità filtro (opzionale)



Cromo lucido	LVOK123/EHTCR	<b>NEW</b>	1.400,00 €
Inox spazzolato	LVOK123/EHTIX	<b>NEW</b>	1.575,00 €
Mora opaco	LVOK123/EHTBM	<b>NEW</b>	1.575,00 €



CARTRIDGE  
WARRANTY



RCR350  
39,00 €

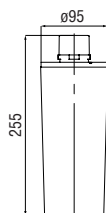

RAE219/76CR  
60,00 € - 10 pz.

**Ricambio filtro GIOIA**

- Capacità 1.700 lt (18 °f)
- Protezione ottimale dispositivo sotto lavello
- Durata massima 1 anno

AV00405

**NEW**

109,00 €

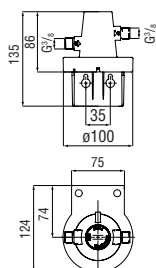
**Ricambio staffa di supporto filtro**

- Compatibile con filtro GIOIA

RVR93094/CLA

**NEW**

100,00 €

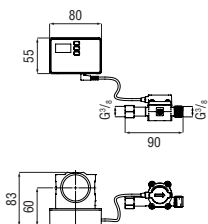
**Ricambio contaltri per controllo capacità filtro**

- Batterie non incluse

RVR93096/CLA

**NEW**

198,00 €

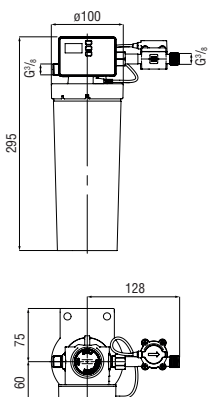
**Kit ricambio completo**

- Filtro a 5 fasi GIOIA (durata massima 1 anno oppure capacità media 1.700 lt a 18 °f @ bypass livello 6)
- Staffa di supporto filtro
- Contaltri per controllo capacità filtro (batterie non incluse)

RKTCLA/FIL

**NEW**

353,00 €

SORGENTE

# FRIZZA

Centro Stile Nobili

Sorgente Frizza eroga istantaneamente acqua corrente miscelata e tre tipologie di acqua filtrata: temperatura ambiente, refrigerata, refrigerata frizzante. Grazie all'app Nobili Sorgente è possibile scegliere la temperatura e la quantità di anidride carbonica presente nell'acqua, oltre a tenere sotto controllo lo stato del sistema tramite verifica dei livelli dei consumabili, come bombole e filtri.



Cromo lucido



Inox spazzolato



Mora opaco



Ambra spazzolato PVD

**Bicomando elettronico con sistema frigo-gasatore**

- Limitatore di portata con freno al 50%
- Bocca girevole 180° (adattabile 120° o 360°)
- Aeratore Dual Flow M 22 x 1
- Flessibili inox ø 3/8"
- LED a colori per la selezione del tipo di acqua da erogare (acqua filtrata ambiente, filtrata refrigerata, filtrata refrigerata gasata)
- Canali di erogazione separati per acqua filtrata ed acqua gasata filtrata
- Dispositivo elettronico frigo-gasatore certificato CE
- Temperatura acqua refrigerata selezionabile tra 4° e 10° tramite app Nobili Sorgente
- Grado di gasatura personalizzabile
- Eroga fino a 1,7 lt al di sotto di 10 °C
- Raffredda di 10 °C fino a 2,2 lt di acqua in 8 minuti (circa 16,5 lt/ora, temperatura acqua in entrata 15 °C)
- Filtro a 5 fasi GIOIA con tecnologia RFID\* (durata massima 1 anno oppure capacità media 1.700 lt a 18 °f @ bypass livello 6)
- Bombola CO2 compresa nel set (compatibile con tutte le bombole con attacco Sodastream compatibile TP21x4)
- Connettività WiFi con app Nobili Sorgente su Android e Apple (disponibili rispettivamente su Google Play Store e Apple Store)
- Massima potenza 230 W
- Voltaggio 230 V (50 Hz)
- Alimentazione Schuko EU

\*Unico filtro compatibile acquistabile presso Nobili o distributori

Nota: requisiti minimi installazione L 30 x P 55 x H 49 cm (previa adeguata ventilazione del cabinet)

I marchi Apple e Apple Store sono di proprietà esclusiva di Apple Inc., marchio registrato. Apple non è responsabile per il funzionamento di questo dispositivo né della sua compatibilità con esso e/o con gli standard di sicurezza regolatori.

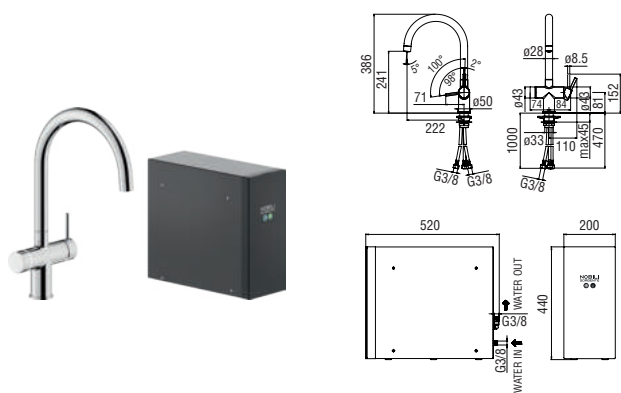

Cromo lucido	LVOK133/EFRCR	<b>NEW</b>	2.700,00 €
Inox spazzolato	LVOK133/EFRIX	<b>NEW</b>	2.900,00 €
Mora opaco	LVOK133/EFRBM	<b>NEW</b>	2.900,00 €
Ambra spazzolato PVD	LVOK133/EFRGTP	<b>NEW</b>	3.050,00 €

**20 YEARS**  
CARTRIDGE WARRANTY

RCR350  
39,00 €

RAE219/77CR  
60,00 € - 10 pz.

**Bicomando elettronico con sistema frigo-gasatore**

- Limitatore di portata con freno al 50%
- Bocca girevole 180° (adattabile 120° o 360°)
- Doccetta Dual Flow estraibile
- Flessibili inox ø 3/8"
- LED a colori per la selezione del tipo di acqua da erogare (acqua filtrata ambiente, filtrata refrigerata, filtrata refrigerata gasata)
- Canali di erogazione separati per acqua filtrata ed acqua gasata filtrata
- Dispositivo elettronico frigo-gasatore certificato CE
- Temperatura acqua refrigerata selezionabile tra 4° e 10° tramite app Nobili Sorgente
- Grado di gasatura personalizzabile
- Eroga fino a 1,7 lt al di sotto di 10 °C
- Raffredda di 10 °C fino a 2,2 lt di acqua in 8 minuti (circa 16,5 lt/ ora, temperatura acqua in entrata 15 °C)
- Filtro a 5 fasi GIOIA con tecnologia RFID\* (durata massima 1 anno oppure capacità media 1.700 lt a 18 °f @ bypass livello 6)
- Bombola CO2 compresa nel set (compatibile con tutte le bombole con attacco Sodastream compatible TP21x4)
- Connettività WiFi con app Nobili Sorgente su Android e Apple (disponibili rispettivamente su Google Play Store e Apple Store)
- Massima potenza 230 W
- Voltaggio 230 V (50 Hz)
- Alimentazione Schuko EU

\*Unico filtro compatibile acquistabile presso Nobili o distributori

Nota: requisiti minimi installazione L 30 x P 55 x H 49 cm (previa adeguata ventilazione del cabinet)

I marchi Apple e Apple Store sono di proprietà esclusiva di Apple Inc., marchio registrato. Apple non è responsabile per il funzionamento di questo dispositivo né della sua compatibilità con esso e/o con gli standard di sicurezza regolatori.

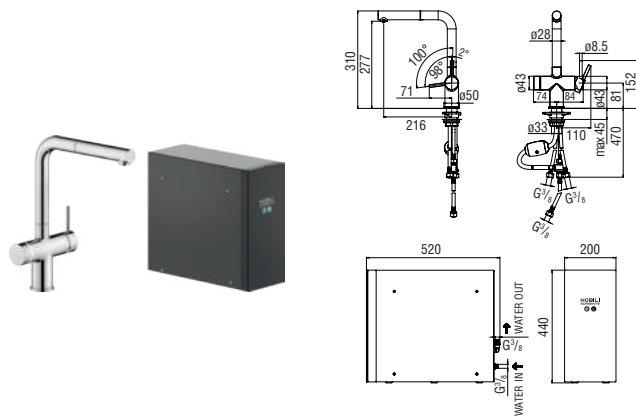

Cromo lucido	LVOK117/EFRCR	<b>NEW</b>	2.850,00 €
Inox spazzolato	LVOK117/EFRIX	<b>NEW</b>	3.050,00 €
Mora opaco	LVOK117/EFRBM	<b>NEW</b>	3.050,00 €

**20 YEARS**  
CARTRIDGE  
WARRANTY

  
RCR350  
39,00 €

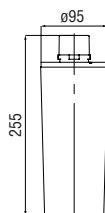
**Ricambio filtro GIOIA**

- Capacità 1.700 lt (18 °f)
- Protezione ottimale dispositivo sotto lavello
- Durata massima 1 anno

- AV00405 **NEW** 109,00 €



SORGENTE

# FRIZZA & BOLLE

Centro Stile Nobili

Sorgente Frizza & Bolle è il sistema All-in-One in grado di erogare istantaneamente acqua corrente miscelata, acqua bollente a 99 °C e tre tipologie di acqua filtrata: temperatura ambiente, refrigerata, refrigerata frizzante. Grazie all'app Nobili Sorgente è possibile scegliere la temperatura e la quantità di anidride carbonica presente nell'acqua, oltre a tenere sotto controllo lo stato del sistema tramite verifica dei livelli dei consumabili, come bombole e filtri.



**Bicomando elettronico con sistema All-in-One**

- Limitatore di portata con freno al 50%
- Bocca girevole 180° (adattabile 120° o 360°)
- Aeratore anticalcare M 22 x 1
- Flessibili inox ø 3/8"
- LED a colori per la selezione del tipo di acqua da erogare (acqua filtrata ambiente, filtrata refrigerata, filtrata refrigerata gasata, filtrata bollente)
- Canali di erogazione separati per acqua filtrata, acqua filtrata gasata ed acqua filtrata bollente
- Dispositivo elettronico All-in-One certificato CE
- Temperatura acqua refrigerata selezionabile tra 4° e 10° tramite app Nobili Sorgente
- Grado di gasatura personalizzabile
- Eroga acqua bollente istantanea a 99 °C (fino a 2,6 lt > 99 °C)
- Eroga fino a 1,7 lt al di sotto di 10 °C
- Raffredda di 10 °C fino a 2,2 lt di acqua in 8 minuti (circa 16,5 lt/ora, temperatura acqua in entrata 15 °C)
- Filtro a 5 fasi GIOIA con tecnologia RFID\* (durata massima 1 anno oppure capacità media 1.700 lt a 18 °f @ bypass livello 6)
- Bombola CO2 compresa nel set (compatibile con tutte le bombole con attacco Sodastream compatibile TP21x4)
- Connettività WiFi con app Nobili Sorgente su Android e Apple (disponibili rispettivamente su Google Play Store e Apple Store)
- Massima potenza 1800 W
- Voltaggio 230 V (50 Hz)
- Alimentazione Schuko EU

\*Unico filtro compatibile acquistabile presso Nobili o distributori

Nota: variante con presa UK disponibile con altro codice prodotto

Nota: requisiti minimi installazione L 30 x P 55 x H 49 cm (previa adeguata ventilazione del cabinet)

Nota: prodotto non destinato a mercato francese

I marchi Apple e Apple Store sono di proprietà esclusiva di Apple Inc., marchio registrato. Apple non è responsabile per il funzionamento di questo dispositivo né della sua compatibilità con esso e/o con gli standard di sicurezza regolatori.

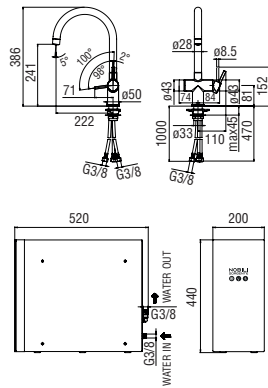

Cromo lucido	LVOK133/AIOCR	<b>NEW</b>	3.600,00 €
Inox spazzolato	LVOK133/AIOIX	<b>NEW</b>	3.800,00 €
Mora opaco	LVOK133/AIOBM	<b>NEW</b>	3.800,00 €
Ambra spazzolato PVD	LVOK133/AIOGTP	<b>NEW</b>	3.900,00 €

**20**  
YEARS  
CARTRIDGE  
WARRANTY

RCR350  
39,00 €

RAE219/76CR  
60,00 € - 10 pz.

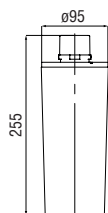

**Ricambio filtro GIOIA**

- Capacità 1.700 lt (18 °f)
- Protezione ottimale dispositivo sotto lavello
- Durata massima 1 anno

---

- AV00405 **NEW** 109,00 €



CUCINA

# NOBILI

Designers vari

Svariati modelli, differenti per design, tipologia, funzionalità e finitura, assecondano ergonomia ed affidabilità attraverso una vocazione altamente innovativa unita ad una marcata identità stilistica: espressioni suggestive orientate all'eccellenza produttiva valorizzano il piano lavello e assicurano la migliore esperienza d'utilizzo.



LEVANTE

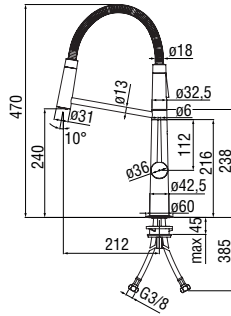

**Monocomando**

- Limitatore di energia con apertura in acqua fredda
- Limitatore di portata con freno al 50%
- Bocca girevole 360°
- Aeratore anticalcare M 24 x 1
- Doccetta monogetto orientabile 360° ad appoggio magnetico
- Flessibili inox ø 3/8"

Cromo lucido	MV123300CR	552,00 €
Inox spazzolato	MV123300IX	830,00 €
Mora opaco	MV123300BM	830,00 €



CARTRIDGE  
WARRANTY



RCR280/D  
39,00 €



RAEK222/27  
45,00 € - 10 pz.

MOVE

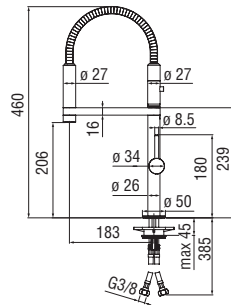

**Monocomando**

- Limitatore di portata con freno al 50%
- Bocca girevole 360°
- Aeratore anticalcare M 24 x 1
- Doccetta monogetto orientabile 360° ad appoggio magnetico
- Flessibili inox ø 3/8"

Cromo lucido	MV92300/50CR	507,00 €
Inox spazzolato	MV92300/50IX	761,00 €
Mora opaco	MV92300/50BM	761,00 €



CARTRIDGE  
WARRANTY



RCR280/D  
39,00 €



RAEK222/27  
45,00 € - 10 pz.

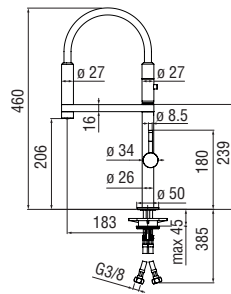

**Monocomando**

- Limitatore di portata con freno al 50%
- Bocca girevole 360°
- Aeratore anticalcare M 24 x 1
- Doccetta monogetto orientabile 360° ad appoggio magnetico
- Flessibili inox ø 3/8"

Cromo lucido	MV92400/50CR	473,00 €
Inox spazzolato	MV92400/50IX	711,00 €
Mora opaco	MV92400/50BM	711,00 €



CARTRIDGE  
WARRANTY



RCR280/D  
39,00 €



RAEK222/27  
45,00 € - 10 pz.

HERON

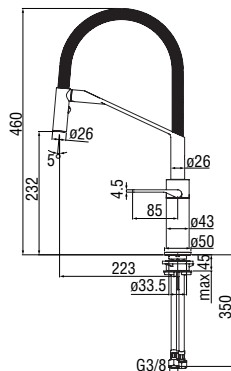

**Monocomando**

- Limitatore di energia con apertura in acqua fredda
- Bocca girevole 360°
- Doccetta a 2 getti orientabile
- Flessibili inox ø 3/8"

Cromo l. e Mora o.	HR125300CB	479,00 €
Inox s. e Mora o.	HR125300IB	646,00 €



RCR2020  
41,00 €

LAMP

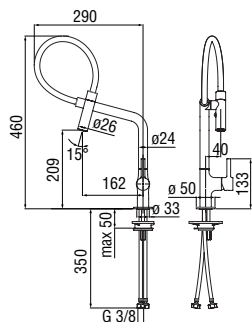

**Monocomando**

- Limitatore di portata con freno al 50%
- Bocca girevole 360°
- Doccetta a 2 getti orientabile ad aggancio magnetico
- Flessibili inox ø 3/8"

Cromo lucido	MP119400CR	410,00 €
Inox spazzolato	MP119400IX	614,00 €
Mora opaco	MP119400BM	614,00 €



CARTRIDGE  
WARRANTY



RCR280/D  
39,00 €

YPSILON

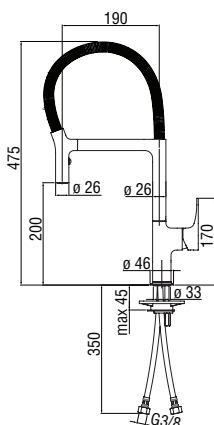

**Monocomando**

- Limitatore di portata con freno al 50%
- Bocca girevole 360°
- Doccetta a 2 getti orientabile ad aggancio magnetico
- Flessibili inox ø 3/8"

Cromo lucido	MP120300CR	383,00 €
Inox spazzolato	MP120300IX	574,00 €



CARTRIDGE  
WARRANTY



RCR350  
39,00 €

FLAT

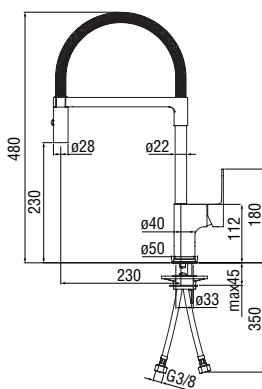

**Monocomando**

- Limitatore di portata con freno al 50%
- Bocca girevole 360°
- Doccetta a 2 getti orientabile
- Flessibili inox ø 3/8"

Cromo lucido	MP121300CR	369,00 €
--------------	------------	----------



CARTRIDGE  
WARRANTY



RCR350  
39,00 €

MASTER

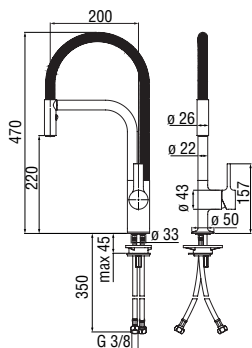

**Monocomando**

- Limitatore di portata con freno al 50%
- Bocca girevole
- Doccetta a 2 getti orientabile ad aggancio magnetico
- Flessibili inox ø 3/8"

Cromo lucido	MP118300CR	400,00 €
Inox spazzolato	MP118300IX	600,00 €



CARTRIDGE  
WARRANTY



RCR350  
39,00 €

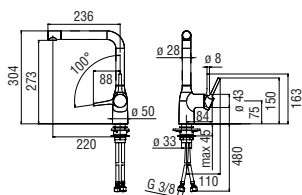

**Monocomando**

- Limitatore di portata con freno al 50%
- Bocca girevole 180° (adattabile 120° o 360°)
- Aeratore anticalcare M 24 x 1
- Flessibili inox ø 3/8"

Cromo lucido	CUI28113CR	265,00 €
Grafite spazzolato PVD	CUI28113GUP	424,00 €
Mora opaco	CUI28113BM	358,00 €
Ambra spazzolato PVD	CUI28113GTP	424,00 €
Argilla spazzolato PVD	CUI28113RTP	424,00 €



CARTRIDGE WARRANTY



RCR350 39,00 €



RAEK219/73CR 65,00 € - 10 pz.

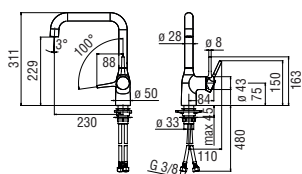

**Monocomando**

- Limitatore di portata con freno al 50%
- Bocca girevole 180° (adattabile 120° o 360°)
- Aeratore anticalcare M 24 x 1
- Flessibili inox ø 3/8"

Cromo lucido	CUI28123CR	245,00 €
Grafite spazzolato PVD	CUI28123GUP	392,00 €
Mora opaco	CUI28123BM	330,00 €
Ambra spazzolato PVD	CUI28123GTP	392,00 €
Argilla spazzolato PVD	CUI28123RTP	392,00 €



CARTRIDGE WARRANTY



RCR350 39,00 €



RAEK222/45 63,00 € - 10 pz.

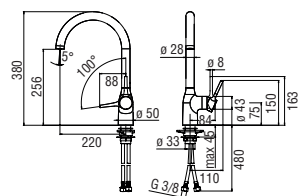

**Monocomando**

- Limitatore di portata con freno al 50%
- Bocca girevole 180° (adattabile 120° o 360°)
- Aeratore anticalcare M 24 x 1
- Flessibili inox ø 3/8"

Cromo lucido	CUI28133CR	245,00 €
Grafite spazzolato PVD	CUI28133GUP	392,00 €
Mora opaco	CUI28133BM	330,00 €
Ambra spazzolato PVD	CUI28133GTP	392,00 €
Argilla spazzolato PVD	CUI28133RTP	392,00 €



CARTRIDGE WARRANTY



RCR350 39,00 €



RAEK222/45 63,00 € - 10 pz.

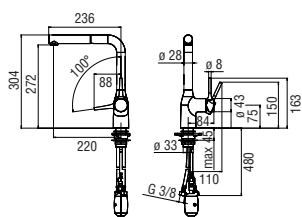

**Monocomando**

- Limitatore di portata con freno al 50%
- Bocca girevole 180° (adattabile 120° o 360°)
- Doccetta monogetto estraibile
- Flessibili inox ø 3/8"

Cromo lucido	CUI28117/1CR	306,00 €
Grafite spazzolato PVD	CUI28117/1GUP	490,00 €
Mora opaco	CUI28117/1BM	414,00 €
Ambra spazzolato PVD	CUI28117/1GTP	490,00 €
Argilla spazzolato PVD	CUI28117/1RTP	490,00 €



CARTRIDGE WARRANTY



RCR350 39,00 €

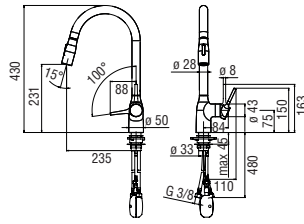

**Monocomando**

- Limitatore di portata con freno al 50%
- Bocca girevole 180° (adattabile 120° o 360°)
- Doccetta a 2 getti estraibile
- Flessibili inox  $\varnothing$  3/8"

Cromo lucido	CU128137CR	318,00 €
Grafite spazzolato PVD	CU128137GUP	509,00 €
Mora opaco	CU128137BM	439,00 €
Ambra spazzolato PVD	CU128137GTP	509,00 €
Argilla spazzolato PVD	CU128137RTP	509,00 €



CARTRIDGE  
WARRANTY



RCR350  
39,00 €

POP

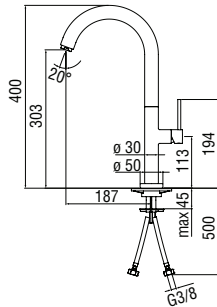
**Monocomando**

- Bocca girevole 360°
- Aeratore anticalcare M 24 x 1
- Flessibili inox  $\varnothing$  3/8"

Cromo lucido	PO108113CR	205,00 €
--------------	------------	----------



RCR107040  
18,00 €

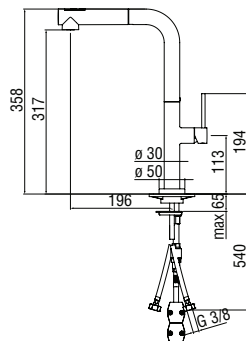

RAEK220/32CR  
45,00 € - 10 pz.

**Monocomando**

- Bocca girevole
- Doccetta a 2 getti estraibile
- Flessibili inox  $\varnothing$  3/8"

Cromo lucido	PO108127CR	281,00 €
--------------	------------	----------

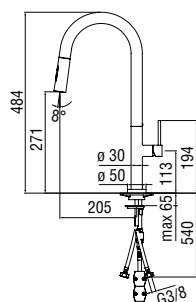

RCR107040  
18,00 €

**Monocomando**

- Bocca girevole 360°
- Doccetta a 2 getti estraibile
- Flessibili inox  $\varnothing$  3/8"

Cromo lucido	PO108137CR	281,00 €
--------------	------------	----------



RCR107040  
18,00 €

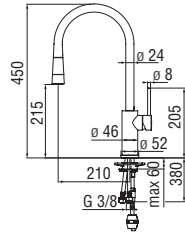

**Monocomando**

- Limitatore di portata con freno al 50%
- Bocca girevole
- Doccetta a 2 getti estraibile
- Flessibili inox  $\varnothing$  3/8"

Cromo lucido WBO0117/2CR 402,00 €



CARTRIDGE WARRANTY



RCR350 39,00 €

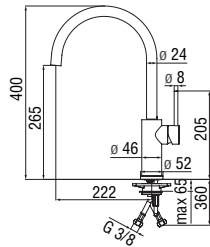

**Monocomando**

- Limitatore di portata con freno al 50%
- Bocca girevole 360°
- Aeratore anticalcare M 21,5 x 1
- Flessibili inox  $\varnothing$  3/8"

Cromo lucido WBO0113CR 261,00 €



CARTRIDGE WARRANTY



RCR350 39,00 €



RAEK222/26 45,00 € - 10 pz.

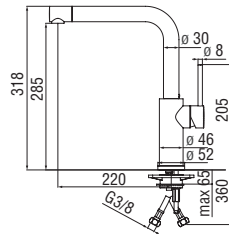

**Monocomando**

- Limitatore di portata con freno al 50%
- Bocca girevole 360°
- Aeratore anticalcare M 24 x 1
- Flessibili inox  $\varnothing$  3/8"

Cromo lucido WBO0123CR 236,00 €



CARTRIDGE WARRANTY



RCR350 39,00 €



RAEK220/66CR 47,00 € - 10 pz.

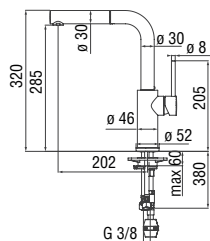

**Monocomando**

- Limitatore di portata con freno al 50%
- Bocca girevole 360°
- Doccetta monogetto estraibile
- Flessibili inox  $\varnothing$  3/8"

Cromo lucido WBO0127CR 320,00 €



CARTRIDGE WARRANTY



RCR350 39,00 €

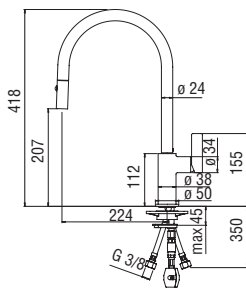

**Monocomando**

- Limitatore di portata con freno al 50%
- Bocca girevole
- Doccetta a 2 getti estraibile
- Flessibili inox ø 3/8"

Cromo lucido	FL96137CR	318,00 €
Cromo l. e Mora o.	FL96137NC	351,00 €
Cromo l. e Neve o.	FL96137WC	351,00 €
Mora opaco	FL96137BM	431,00 €



CARTRIDGE  
WARRANTY



RCR280/D  
39,00 €

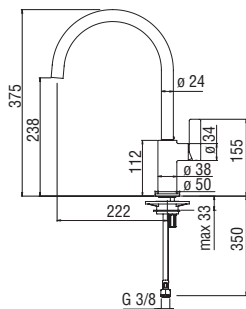

**Monocomando**

- Limitatore di portata con freno al 50%
- Bocca girevole 360°
- Aeratore anticalcare M 21,5 x 1
- Flessibili inox ø 3/8"

Cromo lucido	FL96113CR	207,00 €
Cromo l. e Mora o.	FL96113NC	222,00 €
Cromo l. e Neve o.	FL96113WC	222,00 €
Mora opaco	FL96113BM	284,00 €



CARTRIDGE  
WARRANTY



RCR280/D  
39,00 €



RAEK222/26  
45,00 € - 10 pz.

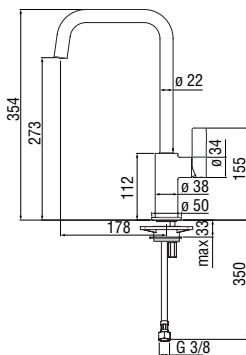

**Monocomando**

- Limitatore di portata con freno al 50%
- Bocca girevole 360°
- Aeratore anticalcare M 18,5 x 1
- Flessibili inox ø 3/8"

Cromo lucido	FL96123CR	207,00 €
Mora opaco	FL96123BM	284,00 €



CARTRIDGE  
WARRANTY



RCR280/D  
39,00 €



RAEK222/23  
43,00 € - 10 pz.

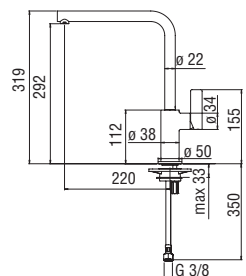

**Monocomando**

- Limitatore di portata con freno al 50%
- Bocca girevole 360°
- Aeratore anticalcare M 18 x 1
- Flessibili inox ø 3/8"

Cromo lucido	FL96133CR	233,00 €
Mora opaco	FL96133BM	315,00 €



CARTRIDGE  
WARRANTY



RCR280/D  
39,00 €



RAEK220/27CR  
43,00 € - 10 pz.

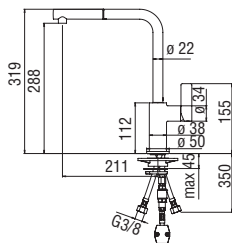

**Monocomando**

- Limitatore di portata con freno al 50%
- Bocca girevole
- Doccetta monogetto estraibile
- Flessibili inox ø 3/8"

Cromo lucido	FL96127CR	299,00 €
Mora opaco	FL96127BM	405,00 €



CARTRIDGE  
WARRANTY



RCR280/D  
39,00 €

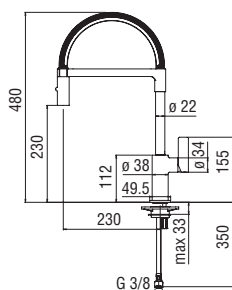

**Monocomando**

- Limitatore di portata con freno al 50%
- Bocca girevole 360°
- Doccetta a 2 getti orientabile
- Flessibili inox ø 3/8"

Cromo lucido	FL96300CR	359,00 €
--------------	-----------	----------



CARTRIDGE  
WARRANTY



RCR280/D  
39,00 €

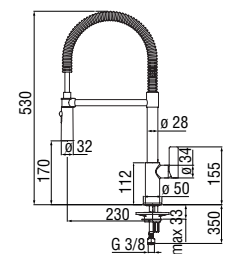

**Monocomando**

- Limitatore di portata con freno al 50%
- Bocca girevole 360°
- Doccetta a 2 getti orientabile ad aggancio magnetico
- Flessibili inox ø 3/8"

Cromo lucido	FL96320/1CR	382,00 €
--------------	-------------	----------



CARTRIDGE  
WARRANTY



RCR280/D  
39,00 €

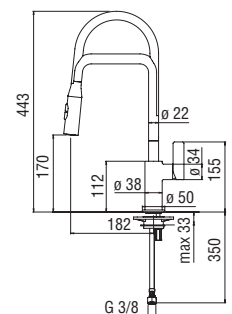

**Monocomando**

- Limitatore di portata con freno al 50%
- Bocca girevole 360°
- Doccetta a 2 getti orientabile
- Flessibili inox ø 3/8"

Cromo lucido	FL96400/1CR	402,00 €
--------------	-------------	----------



CARTRIDGE  
WARRANTY



RCR280/D  
39,00 €

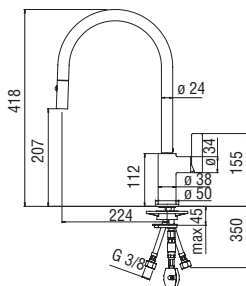

**Monocomando in acciaio inox**

- Limitatore di portata con freno al 50%
- Bocca girevole
- Doccetta a 2 getti estraibile
- Flessibili inox  $\varnothing$  3/8"

Inox 316L FL961371P 466,00 €



CARTRIDGE  
WARRANTY



RCR280/D  
39,00 €

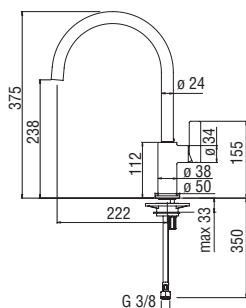

**Monocomando in acciaio inox**

- Limitatore di portata con freno al 50%
- Bocca girevole 360°
- Aeratore anticalcare M 21,5 x 1
- Flessibili inox  $\varnothing$  3/8"

Inox 316L FL961131P 292,00 €



CARTRIDGE  
WARRANTY



RCR280/D  
39,00 €



RAEK222/26  
45,00 € - 10 pz.

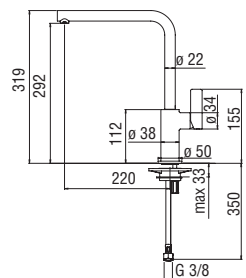

**Monocomando in acciaio inox**

- Limitatore di portata con freno al 50%
- Bocca girevole 360°
- Aeratore anticalcare M 18 x 1
- Flessibili inox  $\varnothing$  3/8"

Inox 316L FL961331P 344,00 €



CARTRIDGE  
WARRANTY



RCR280/D  
39,00 €

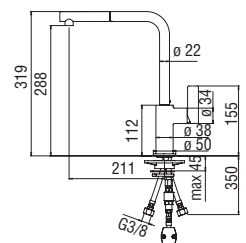

**Monocomando in acciaio inox**

- Limitatore di portata con freno al 50%
- Bocca girevole
- Doccetta monogetto estraibile
- Flessibili inox  $\varnothing$  3/8"

Inox 316L FL961271P 442,00 €



CARTRIDGE  
WARRANTY

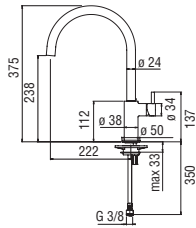

RCR280/D  
39,00 €

**Monocomando**

- Limitatore di portata con freno al 50%
- Bocca girevole 360°
- Aeratore anticalcare M 21,5 x 1
- Flessibili inox ø 3/8"

Cromo lucido	CU96113CR	207,00 €
Grafite spazzolato PVD	CU96113GUP	332,00 €
Ambra spazzolato PVD	CU96113GTP	332,00 €
Argilla spazzolato PVD	CU96113RTP	332,00 €



CARTRIDGE  
WARRANTY



RCR280/D  
39,00 €

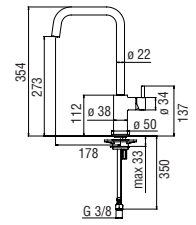

RAEK222/26  
45,00 € - 10 pz.

**Monocomando**

- Limitatore di portata con freno al 50%
- Bocca girevole 360°
- Aeratore anticalcare M 18,5 x 1
- Flessibili inox ø 3/8"

Cromo lucido	CU96123CR	207,00 €
Grafite spazzolato PVD	CU96123GUP	332,00 €
Ambra spazzolato PVD	CU96123GTP	332,00 €
Argilla spazzolato PVD	CU96123RTP	332,00 €



CARTRIDGE  
WARRANTY



RCR280/D  
39,00 €



RAEK222/23  
43,00 € - 10 pz.

## VELIS

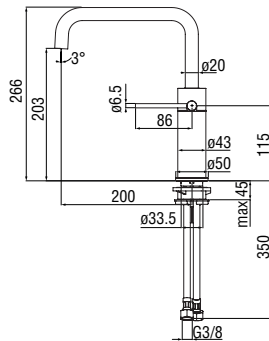
**Monocomando**

- Limitatore di energia con apertura in acqua fredda
- Aeratore anticalcare M 18 x 1, portata 5 l/min
- Bocca girevole
- Flessibili inox ø 3/8"

Cromo lucido	VE125134CR	369,00 €
Inox spazzolato	VE125134IX	552,00 €



RCR2020  
41,00 €

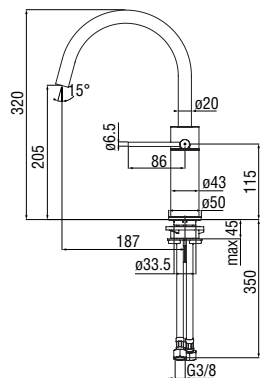

RAEK222/42  
45,00 € - 10 pz.

**Monocomando**

- Limitatore di energia con apertura in acqua fredda
- Bocca girevole 360°
- Aeratore anticalcare M 18 x 1, portata 5 l/min
- Flessibili inox ø 3/8"

Cromo lucido	VE125133CR	369,00 €
Inox spazzolato	VE125133IX	552,00 €



RCR2020  
41,00 €



RAEK222/42  
45,00 € - 10 pz.

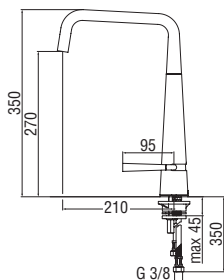

**Monocomando**

- Limitatore di energia con apertura in acqua fredda
- Bocca girevole 360°
- Aeratore anticalcare M 16,5 x 1
- Flessibili inox ø 3/8"

Cromo lucido LK00113CR 289,00 €



RCR2020  
41,00 €



RAEK222/20  
58,00 € - 10 pz.

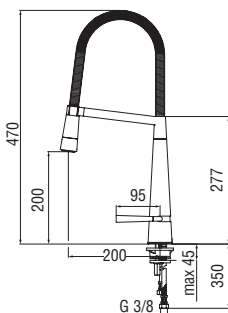

**Monocomando**

- Limitatore di energia con apertura in acqua fredda
- Bocca girevole 360°
- Doccetta a 2 getti orientabile
- Flessibili inox ø 3/8"

Cromo lucido LK00300CR 450,00 €



RCR2020  
41,00 €

LIVE

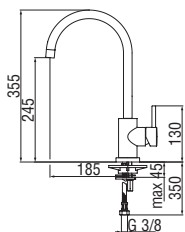

**Monocomando**

- Limitatore di portata con freno al 50%
- Bocca girevole 360°
- Aeratore anticalcare M 16 x 1
- Flessibili inox ø 3/8"

Cromo lucido	LV00133CR	171,00 €
Inox spazzolato	LV00133IX	257,00 €
Mora opaco	LV00133BM	257,00 €
Neve opaco	LV00133WM	257,00 €



CARTRIDGE  
WARRANTY



RCR360/D  
39,00 €



RAEK222/10CR  
58,00 € - 10 pz.

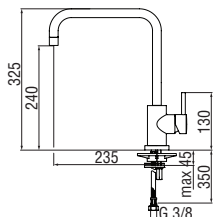

**Monocomando**

- Limitatore di portata con freno al 50%
- Bocca girevole 360°
- Aeratore anticalcare M 16 x 1
- Flessibili inox ø 3/8"

Cromo lucido	LV00134CR	171,00 €
Inox spazzolato	LV00134IX	257,00 €
Mora opaco	LV00134BM	257,00 €
Neve opaco	LV00134WM	257,00 €



CARTRIDGE  
WARRANTY



RCR360/D  
39,00 €



RAEK222/10CR  
58,00 € - 10 pz.

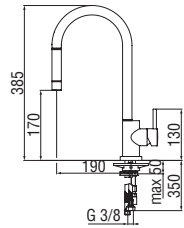

**Monocomando**

- Limitatore di portata con freno al 50%
- Bocca girevole
- Doccetta monogetto estraibile
- Flessibili inox ø 3/8"

Cromo lucido	LV00137/1CR	233,00 €
Inox spazzolato	LV00137/1IX	350,00 €



CARTRIDGE  
WARRANTY



RCR350  
39,00 €

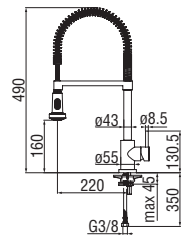

**Monocomando**

- Limitatore di portata con freno al 50%
- Bocca girevole 360°
- Doccetta a 2 getti orientabile
- Flessibili inox ø 3/8"

Cromo lucido	LV00300/3CR	246,00 €
Inox spazzolato	LV00300/3IX	370,00 €



CARTRIDGE  
WARRANTY



RCR360/D  
39,00 €

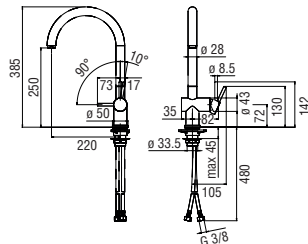

**Monocomando**

- Limitatore di portata con freno al 50%
- Bocca girevole 360°
- Aeratore anticalcare M 24 x 1
- Flessibili inox ø 3/8"

Cromo lucido	BR00233CR	237,00 €
Inox spazzolato	BR00233IX	355,00 €
Mora opaco	BR00233BM	320,00 €



CARTRIDGE  
WARRANTY



RCR350  
39,00 €



RAEK220/32CR  
45,00 € - 10 pz.

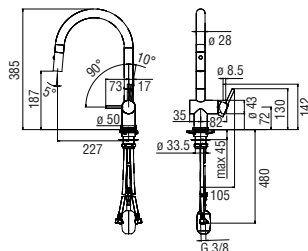

**Monocomando**

- Limitatore di portata con freno al 50%
- Bocca girevole 360°
- Doccetta a 2 getti estraibile
- Flessibili inox ø 3/8"

Cromo lucido	BR00237CR	314,00 €
Inox spazzolato	BR00237IX	472,00 €
Mora opaco	BR00237BM	425,00 €



CARTRIDGE  
WARRANTY



RCR350  
39,00 €

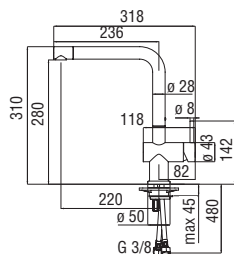

**Monocomando**

- Limitatore di portata con freno al 50%
- Bocca girevole 360°
- Aeratore anticalcare M 24 x 1
- Flessibili inox ø 3/8"

Cromo lucido	LVO0113CR	261,00 €
Inox spazzolato	LVO0113IX	393,00 €
Mora opaco	LVO0113BM	355,00 €
Neve opaco	LVO0113WM	355,00 €



CARTRIDGE  
WARRANTY



RCR350  
39,00 €

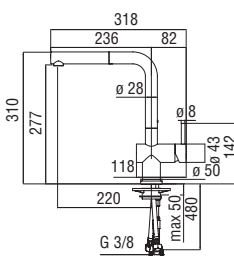

RAEK220/66CR  
47,00 € - 10 pz.

**Monocomando**

- Limitatore di portata con freno al 50%
- Bocca girevole 360°
- Doccetta monogetto estraibile
- Flessibili inox ø 3/8"

Cromo lucido	LVO0117CR	301,00 €
Inox spazzolato	LVO0117/1IX	453,00 €
Mora opaco	LVO0117/1BM	405,00 €
Neve opaco	LVO0117/1WM	405,00 €



CARTRIDGE  
WARRANTY

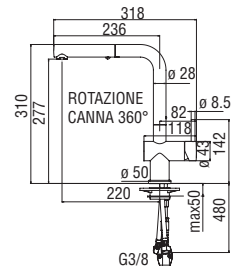

RCR350  
39,00 €

**Monocomando**

- Limitatore di portata con freno al 50%
- Bocca girevole 360°
- Doccetta a 2 getti estraibile
- Flessibili inox ø 3/8"

Cromo lucido	LVO0117/2CR	330,00 €
Inox spazzolato	LVO0117/2IX	495,00 €
Mora opaco	LVO0117/2BM	<b>NEW</b> 445,00 €



CARTRIDGE  
WARRANTY

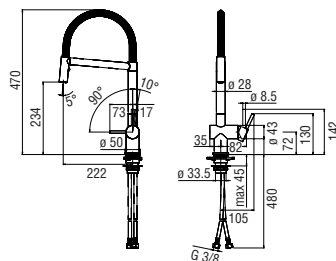

RCR350  
39,00 €

**Monocomando**

- Limitatore di portata con freno al 50%
- Bocca girevole 360°
- Doccetta a 2 getti orientabile
- Flessibili inox ø 3/8"

Cromo lucido	BR00300CR	350,00 €
Mora opaco	BR00300BM	472,00 €



CARTRIDGE  
WARRANTY

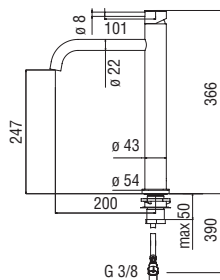

RCR350  
39,00 €

**Monocomando**

- Limitatore di portata con freno al 50%
- Corpo girevole
- Aeratore anticalcare M 18,5 x 1
- Flessibili inox  $\varnothing$  3/8"

Cromo lucido LV00713CR 259,00 €

CARTRIDGE  
WARRANTYRCR350  
39,00 €RAEK222/23  
43,00 € - 10 pz.

ACQUERELLI

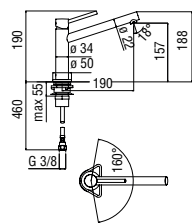
**Monocomando**

- Limitatore di portata con freno al 50%
- Corpo girevole
- Aeratore anticalcare M 18 x 1
- Flessibili inox  $\varnothing$  3/8"

Cromo lucido AQ93113/1CR 189,00 €

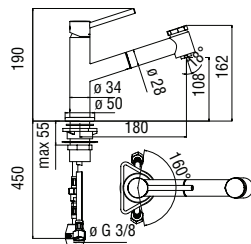
CARTRIDGE  
WARRANTYRCR280/D  
39,00 €RAEK220/27CR  
43,00 € - 10 pz.**Monocomando**

- Limitatore di portata con freno al 50%
- Corpo girevole
- Doccetta a 2 getti estraibile
- Flessibili inox  $\varnothing$  3/8"

Cromo lucido AQ93117CR 215,00 €

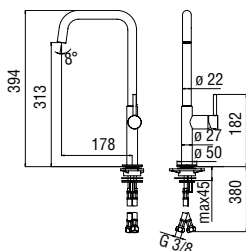
CARTRIDGE  
WARRANTYRCR280/D  
39,00 €RAEK220/27CR  
43,00 € - 10 pz.**Monocomando**

- Limitatore di portata con freno al 50%
- Bocca girevole 360°
- Aeratore anticalcare M 18,5 x 1
- Flessibili inox  $\varnothing$  3/8"

Cromo lucido AQ93113CR 215,00 €

CARTRIDGE  
WARRANTYRCR280/D  
39,00 €RAEK222/23  
43,00 € - 10 pz.

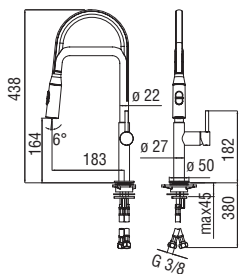

**Monocomando**

- Limitatore di portata con freno al 50%
- Bocca girevole 360°
- Doccetta a 2 getti orientabile
- Flessibili inox ø 3/8"

Cromo lucido AQ93300CR 290,00 €



CARTRIDGE  
WARRANTY



RCR280/D  
39,00 €

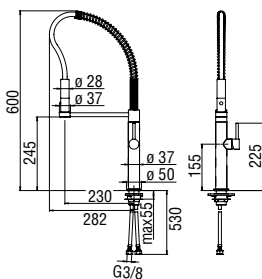

**Monocomando**

- Limitatore di portata con freno al 50%
- Bocca girevole 360°
- Doccetta a 2 getti orientabile
- Flessibili inox ø 3/8"

Cromo lucido AQ109300/60CR 610,00 €

Inox spazzolato AQ109300/60IX 793,00 €

Grafite spazzolato PVD AQ109300/60GUP 976,00 €

Ambra spazzolato PVD AQ109300/60GTP 976,00 €



CARTRIDGE  
WARRANTY



RCR280/D  
39,00 €

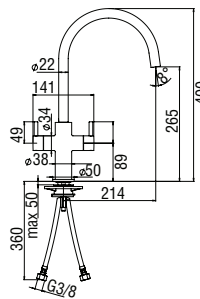

**Bicomando**

- Bocca girevole 360°
- Aeratore anticalcare M 18,5 x 1
- Flessibili inox ø 3/8"

Cromo lucido AQ93824CR 210,00 €



RVT200/5D  
18,00 €



RVT200/5S  
18,00 €



RAEK222/23  
43,00 € - 10 pz.

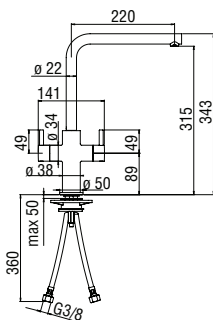

**Bicomando**

- Bocca girevole 360°
- Aeratore anticalcare M 18,5 x 1
- Flessibili inox ø 3/8"

Cromo lucido AQ93823CR 222,00 €



RVT200/5D  
18,00 €



RVT200/5S  
18,00 €



RAEK222/27  
45,00 € - 10 pz.

LOOP

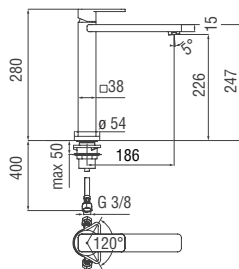

**Monocomando**

- Limitatore di portata con freno al 50%
- Corpo girevole
- Aeratore anticalcare M 24 x 1
- Flessibili inox ø 3/8"

Cromo lucido LP90713CR 504,00 €



CARTRIDGE  
WARRANTY



RCR280/D  
39,00 €



RAEK220/37CR  
47,00 € - 10 pz.

ACQUAVIVA

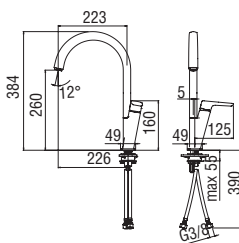

**Monocomando**

- Limitatore di portata con freno al 50%
- Bocca girevole 360°
- Aeratore anticalcare M 24 x 1
- Flessibili inox ø 3/8"

Cromo lucido VV103113CR 207,00 €



CARTRIDGE  
WARRANTY



RCR280/D  
39,00 €



RAEK220/37CR  
47,00 € - 10 pz.

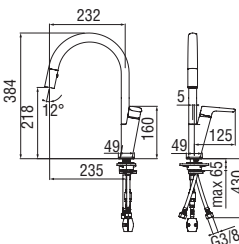

**Monocomando**

- Limitatore di portata con freno al 50%
- Bocca girevole
- Doccetta a 2 getti estraibile
- Flessibili inox ø 3/8"

Cromo lucido VV103127CR 290,00 €



CARTRIDGE  
WARRANTY



RCR280/D  
39,00 €

UP

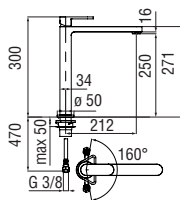

**Monocomando**

- Limitatore di portata con freno al 50%
- Corpo girevole
- Aeratore anticalcare M 24 x 1
- Flessibili inox ø 3/8"

Cromo lucido UP94713CR 417,00 €



CARTRIDGE  
WARRANTY



RCR280/D  
39,00 €

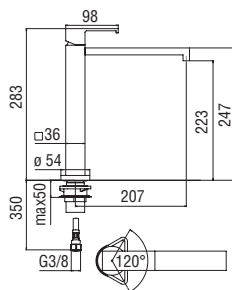

RAEK220/37CR  
47,00 € - 10 pz.

**Monocomando**

- Limitatore di portata con freno al 50%
- Corpo girevole
- Aeratore anticalcare
- Flessibili inox ø 3/8"

Cromo lucido	MI102713CR	609,00 €
Inox spazzolato	MI102713IX	912,00 €



CARTRIDGE  
WARRANTY



RCR280/D  
39,00 €



RAEK222/28  
93,00 € - 5 pz.

## SOFI

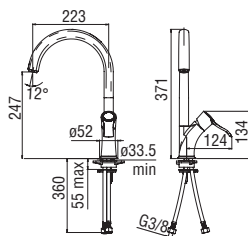
**Monocomando**

- Limitatore di portata con freno al 50%
- Bocca girevole 360°
- Aeratore anticalcare M 24 x 1
- Flessibili inox ø 3/8"

Cromo lucido	SI98113CR	316,00 €
--------------	-----------	----------



CARTRIDGE  
WARRANTY



RCR280/D  
39,00 €

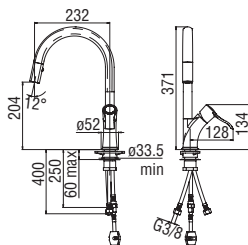

RAEK220/37CR  
47,00 € - 10 pz.

**Monocomando**

- Limitatore di portata con freno al 50%
- Bocca girevole
- Doccetta a 2 getti estraibile
- Flessibili inox ø 3/8"

Cromo lucido	SI98127CR	402,00 €
--------------	-----------	----------



CARTRIDGE  
WARRANTY



RCR280/D  
39,00 €

## CHARLIE

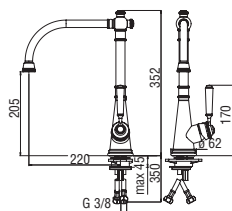
**Monocomando**

- Limitatore di portata con freno al 50%
- Bocca girevole 360°
- Aeratore anticalcare M 22 x 1
- Flessibili inox ø 3/8"

Cromo lucido	CH75513CR	334,00 €
Caffè spazzolato	CH75513SB	<b>NEW</b> 534,00 €
Argilla spazzolato PVD	CH75513RTP	<b>NEW</b> 534,00 €



CARTRIDGE  
WARRANTY



RCR360/D  
39,00 €



RAE220/40CR  
22,00 € - 1 pz.

CHARLIE

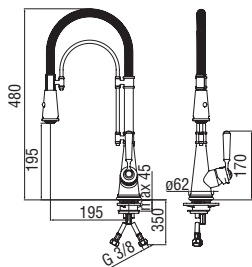

**Monocomando**

- Limitatore di portata con freno al 50%
- Bocca girevole 360°
- Doccetta a 2 getti orientabile
- Flessibili inox ø 3/8"

Cromo lucido	CH75500CR		539,00 €
Caffè spazzolato	CH75500SB	<b>NEW</b>	862,00 €
Argilla spazzolato PVD	CH75500RTP	<b>NEW</b>	862,00 €



CARTRIDGE  
WARRANTY



RCR360/D  
39,00 €

LIRA

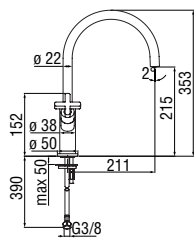

**Bicomando**

- Aeratore anticalcare M 18,5 x 1
- Bocca girevole
- Flessibili inox ø 3/8"

Cromo lucido	LR116217CR		320,00 €
--------------	------------	--	----------



RVT200/26  
18,00 €



RAEK222/23  
43,00 € - 10 pz.

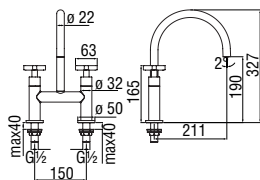

**Bicomando**

- Aeratore anticalcare M 18,5 x 1
- Bocca girevole

Cromo lucido	LR116220CR		431,00 €
--------------	------------	--	----------



RVT200/26  
18,00 €



RAEK222/23  
43,00 € - 10 pz.

CARLOS PRIMERO

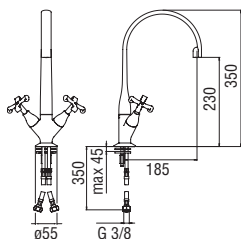

**Bicomando**

- Aeratore anticalcare M 16,5 x 1
- Bocca girevole 360°
- Flessibili inox ø 3/8"

Cromo lucido	CP217CR		281,00 €
--------------	---------	--	----------



RVT200/26  
18,00 €



RAEK219/280  
61,00 € - 10 pz.

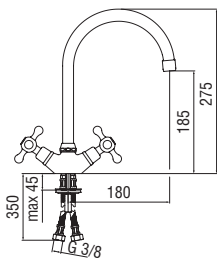

**Bicomando**

- Bocca girevole 360°
- Aeratore anticalcare M 22 x 1
- Flessibili inox ø 3/8"

Cromo lucido GRC5117CR 179,00 €



RVT200/5D  
18,00 €



RAEK219/63CR  
53,00 € - 10 pz.

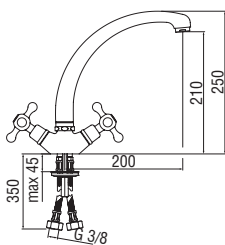

**Bicomando**

- Bocca girevole 360°
- Aeratore anticalcare M 24 x 1
- Flessibili inox ø 3/8"

Cromo lucido GRC5117/5CR 179,00 €



RVT200/5D  
18,00 €



RAEK220/37CR  
47,00 € - 10 pz.

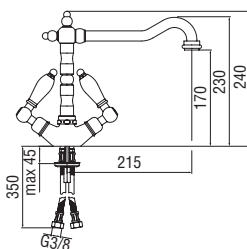

**Bicomando**

- Bocca girevole 360°
- Aeratore anticalcare M 22 x 1
- Flessibili inox ø 3/8"

Cromo lucido AT31117CR 242,00 €

Caffè spazzolato AT31117SB **NEW** 387,00 €

Argilla spazzolato PVD AT31117RTP **NEW** 387,00 €



RVT200/5D  
18,00 €



RVT200/5S  
18,00 €



RAE219/47CR  
23,00 € - 1 pz.

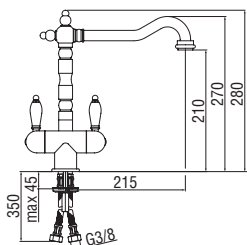

**Bicomando**

- Bocca girevole 360°
- Aeratore anticalcare M 22 x 1
- Flessibili inox ø 3/8"

Cromo lucido AT18117CR 248,00 €

Caffè spazzolato AT18117SB **NEW** 397,00 €

Argilla spazzolato PVD AT18117RTP **NEW** 397,00 €



RVT200/5D  
18,00 €



RVT200/5S  
18,00 €



RAE219/47CR  
23,00 € - 1 pz.

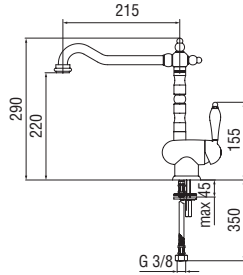

**Monocomando**

- Bocca girevole 360°
- Aeratore anticalcare M 22 x 1
- Flessibili inox ø 3/8"

Cromo lucido	AT18513CR	302,00 €
Caffè spazzolato	AT18513SB	<b>NEW</b> 483,00 €
Argilla spazzolato PVD	AT18513RTP	<b>NEW</b> 483,00 €



RCR440  
39,00 €



RAE219/47CR  
23,00 € - 1 pz.

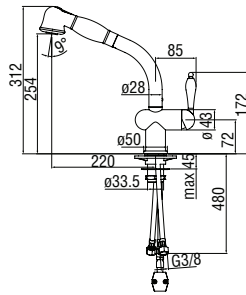

**Monocomando**

- Limitatore di portata con freno al 50%
- Bocca girevole 360°
- Doccetta a 2 getti estraibile
- Flessibili inox ø 3/8"

Cromo lucido	AT18517CR	366,00 €
Caffè spazzolato	AT18517SB	<b>NEW</b> 586,00 €
Argilla spazzolato PVD	AT18517RTP	<b>NEW</b> 586,00 €



**20**  
YEARS  
CARTRIDGE  
WARRANTY



RCR350  
39,00 €



RUBINETTERIA NOBILI

# MATCH

Centro Stile Nobili

Inconfondibile sin dal primo sguardo, esclusivo al primo tocco: l'equilibrio dei richiami materici sublima la ricerca scientifica al concetto di architettura. Tra estetica e performance, sensazioni visive e tattili si concretizzano nel materiale innovativo per eccellenza, il Fenix®, varcando i limiti della progettazione dello spazio cucina.



Cromo lucido



Inox spazzolato



Mora opaco

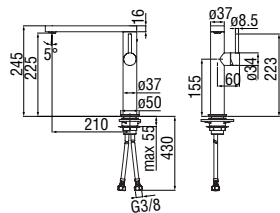

### Monocomando Cromo lucido con rivestimento FENIX NTM®

- Limitatore di portata con freno al 50%
- Bocca girevole 360°
- Aeratore anticalcare M 24 x 1
- Flessibili inox ø 3/8"

Bianco Kos	MH109113BKCR	280,00 €
Zinco Doha	MH109113ZDCR	280,00 €
Grigio Londra	MH109113GLCR	280,00 €
Grigio Bromo	MH109113GBCR	280,00 €
Rosso Jaipur	MH109113RJCR	280,00 €
Nero Ingo	MH109113NICR	280,00 €



CARTRIDGE  
WARRANTY



RCR280/D  
39,00 €



RAEK222/27  
45,00 € - 10 pz.

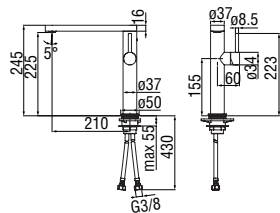

### Monocomando Inox spazzolato con rivestimento FENIX NTM®

- Limitatore di portata con freno al 50%
- Bocca girevole 360°
- Aeratore anticalcare M 24 x 1
- Flessibili inox ø 3/8"

Bianco Kos	MH109113BKIX	405,00 €
Zinco Doha	MH109113ZDIX	405,00 €
Grigio Londra	MH109113GLIX	405,00 €
Grigio Bromo	MH109113GBIX	405,00 €
Rosso Jaipur	MH109113RJIX	405,00 €
Nero Ingo	MH109113NIIX	405,00 €



CARTRIDGE  
WARRANTY



RCR280/D  
39,00 €



RAEK222/27  
45,00 € - 10 pz.

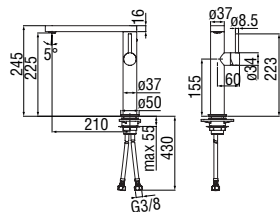

### Monocomando Mora opaco con rivestimento FENIX NTM®

- Limitatore di portata con freno al 50%
- Bocca girevole 360°
- Aeratore anticalcare M 24 x 1
- Flessibili inox ø 3/8"

Bianco Kos	MH109113BKBM	405,00 €
Zinco Doha	MH109113ZDBM	405,00 €
Grigio Londra	MH109113GLBM	405,00 €
Grigio Bromo	MH109113GBBM	405,00 €
Rosso Jaipur	MH109113RJBM	405,00 €
Nero Ingo	MH109113NIBM	405,00 €



CARTRIDGE  
WARRANTY



RCR280/D  
39,00 €



RAEK222/27  
45,00 € - 10 pz.

## CROMO LUCIDO E FENIX NTM®

Una finitura cromata impeccabile ed affascinante, nel pieno rispetto delle più severe normative ambientali. L'estrema brillantezza e lucentezza della superficie del miscelatore si contrappone con decisione all'assoluta opacità del rivestimento Fenix NTM®.



**BKCR** BIANCO KOS



**ZDCR** ZINCO DOHA



**GLCR** GRIGIO LONDRA



**GBCR** GRIGIO BROMO

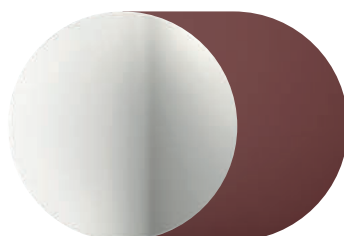

**RJCR** ROSSO JAIPUR



**NICR** NERO INGO

## INOX SPAZZOLATO E FENIX NTM®

Una tonalità che esalta il temperamento attraverso il dettaglio: l'irresistibile freddezza della finitura Inox spazzolato conduce ad atmosfere contemporanee e dal fascino essenziale. Il design pulito di Match si protende verso un minimalismo puro, idealizzato dalle sfumature della superficie.



**BKIX** BIANCO KOS

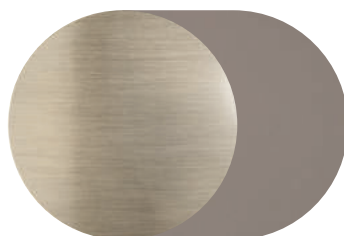

**ZDIX** ZINCO DOHA

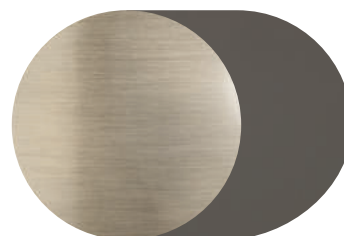

**GLIX** GRIGIO LONDRA



**GBIX** GRIGIO BROMO

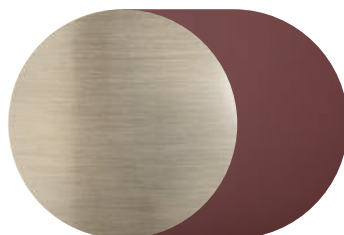

**RJIX** ROSSO JAIPUR



**NIIX** NERO INGO

## MORA OPACO E FENIX NTM®

L'opacità più profonda ed intensa generata dalla combinazione tra miscelatore e rivestimento Fenix NTM® trova la sua massima essenza nella versione Match in finitura Mora opaco: totale assenza di riflesso, sublime percezione tattile, per un'esperienza inconfondibile nell'ambiente cucina.

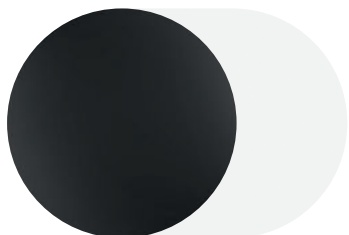

**BKBM** BIANCO KOS

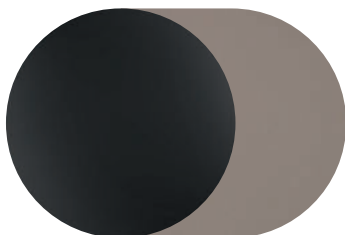

**ZDBM** ZINCO DOHA

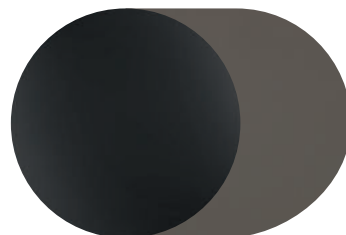

**GLBM** GRIGIO LONDRA



**GBBM** GRIGIO BROMO

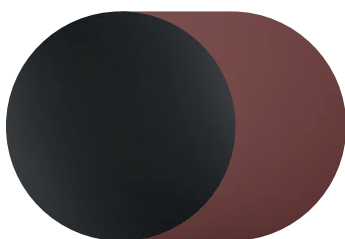

**RJBM** ROSSO JAIPUR



**NIBM** NERO INGO

CUCINA

# ENNE DI NOBILI

Designers vari

La gamma cucina Enne di Nobili è caratterizzata da miscelatori dalle forme semplici e sincere: rappresentano la scelta ideale per la quotidianità, eliminando tutto ciò che non è strettamente necessario e dedicandosi intensamente alla concretezza delle sole esigenze funzionali sul piano lavello, dove ergonomia e affidabilità giocano un ruolo primario.



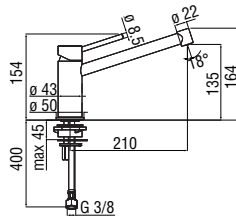

**Monocomando**

- Limitatore di portata con freno al 50%
- Corpo girevole 360°
- Aeratore anticalcare M 18,5 x 1
- Flessibili inox ø 3/8"

Cromo lucido SN00113/25CR 123,00 €



CARTRIDGE  
WARRANTY



RCR280/D  
39,00 €



RAEK222/23  
43,00 € - 10 pz.

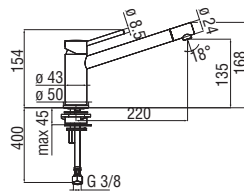

**Monocomando**

- Limitatore di portata con freno al 50%
- Corpo girevole 360°
- Aeratore anticalcare M 18 x 1
- Flessibili inox ø 3/8"

Cromo lucido SN00113/28CR 116,00 €



CARTRIDGE  
WARRANTY



RCR280/D  
39,00 €



RAEK220/27CR  
43,00 € - 10 pz.

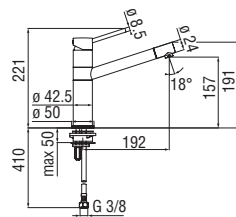

**Monocomando**

- Limitatore di portata con freno al 50%
- Bocca girevole 360°
- Aeratore anticalcare M 18 x 1
- Flessibili inox ø 3/8"

Cromo lucido SN00713CR 162,00 €

Inox spazzolato SN00713IX 244,00 €

Mora opaco SN00713BM 219,00 €



CARTRIDGE  
WARRANTY



RCR350  
39,00 €



RAEK220/27CR  
43,00 € - 10 pz.

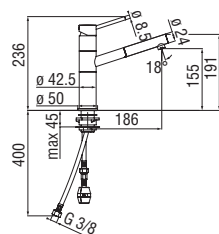

**Monocomando**

- Limitatore di portata con freno al 50%
- Bocca girevole
- Doccetta monogetto estraibile
- Flessibili inox ø 3/8"

Cromo lucido SN00717CR 204,00 €

Inox spazzolato SN00717IX 306,00 €

Mora opaco SN00717BM 276,00 €



CARTRIDGE  
WARRANTY



RCR350  
39,00 €

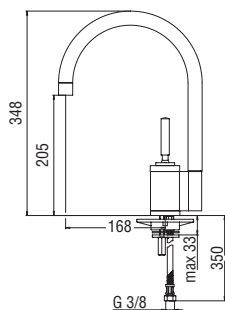

**Monocomando**

- Corpo girevole
- Bocca girevole 360°
- Aeratore anticalcare M 22 x 1
- Flessibili inox ø 3/8"

Cromo lucido OZ45113CR 221,00 €

 RCR465  
41,00 €

 RAEK219/63CR  
53,00 € - 10 pz.

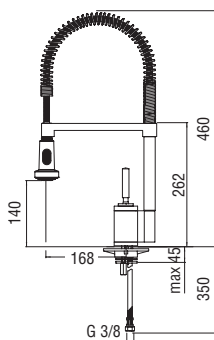

**Monocomando**

- Corpo girevole
- Bocca girevole 360°
- Doccetta a 2 getti orientabile
- Flessibili inox ø 3/8"

Cromo lucido OZ45300/3CR 332,00 €

 RCR465  
41,00 €

OZ T5

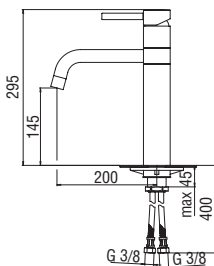

**Monocomando**

- Limitatore di portata con freno al 50%
- Bocca girevole 360°
- Aeratore anticalcare M 24 x 1
- Flessibili inox ø 3/8"

Cromo lucido OZ713/T5CR 246,00 €

 RCR440  
39,00 €

 RAEK219/63CR  
53,00 € - 10 pz.

CUCI

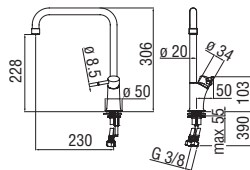

**Monocomando**

- Limitatore di portata con freno al 50%
- Bocca girevole 360°
- Aeratore anticalcare M 22 x 1
- Flessibili inox ø 3/8"

Cromo lucido CU92813CR 88,00 €

 CARTRIDGE WARRANTY

 RCR280/D  
39,00 €

 RAEK221/4CR  
45,00 € - 10 pz.

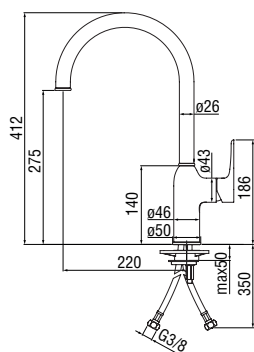
**Monocomando**

- Limitatore di portata con freno al 50%
- Bocca girevole 360°
- Aeratore anticalcare M 24 x 1
- Flessibili inox ø 3/8"

Cromo lucido MP117133CR 222,00 €



CARTRIDGE  
WARRANTY



RCR350  
39,00 €

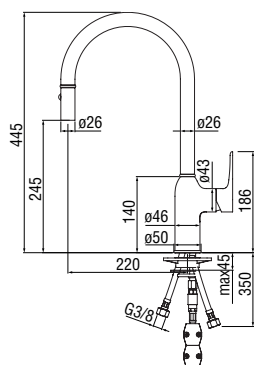

RAEK219/44CR  
27,00 € - 5 pz.

**Monocomando**

- Limitatore di portata con freno al 50%
- Bocca girevole 360°
- Doccetta a 2 getti estraibile
- Flessibili inox ø 3/8"

Cromo lucido MP117137CR 344,00 €



CARTRIDGE  
WARRANTY



RCR350  
39,00 €

## OVETTO

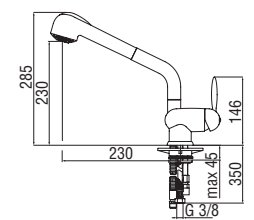
**Monocomando**

- Bocca girevole
- Doccetta a 2 getti estraibile
- Flessibili inox ø 3/8"

Cromo lucido NUI2513/8CR 337,00 €

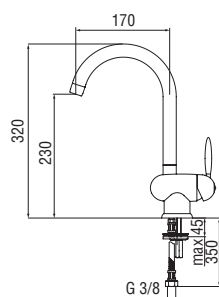

RCR440  
39,00 €

**Monocomando**

- Bocca girevole 360°
- Aeratore anticalcare M 22 x 1
- Flessibili inox ø 3/8"

Cromo lucido NUI2513CR 232,00 €



RCR440  
39,00 €



RAEK221/4CR  
45,00 € - 10 pz.



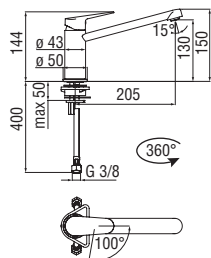

**Monocomando a risparmio energetico**

- Limitatore di energia con apertura in acqua fredda
- Limitatore di portata con freno al 50%
- Corpo girevole 360°
- Aeratore anticalcare M 24 x 1
- Aeratore 5 l/min incluso nella confezione
- Flessibili inox ø 3/8"

Cromo lucido BSE101113/25CR 134,00 €



CARTRIDGE WARRANTY



RCR280/D 39,00 €



RAEK222/27 45,00 € - 10 pz.

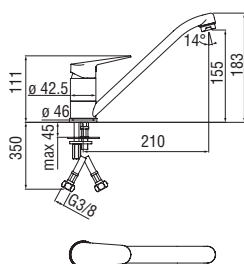

**Monocomando**

- Limitatore di portata con freno al 50%
- Bocca girevole 360°
- Aeratore anticalcare M 24 x 1
- Flessibili inox ø 3/8"

Cromo lucido BSE101113/60CR 93,00 €



CARTRIDGE WARRANTY



RCR350 39,00 €



RAEK220/32CR 45,00 € - 10 pz.

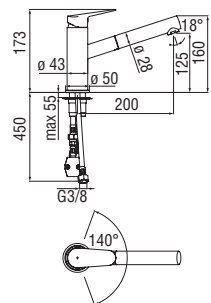

**Monocomando**

- Limitatore di portata con freno al 50%
- Corpo girevole
- Doccetta monogetto estraibile
- Flessibili inox ø 3/8"

Cromo lucido BS101117CR 181,00 €



CARTRIDGE WARRANTY



RCR350 39,00 €

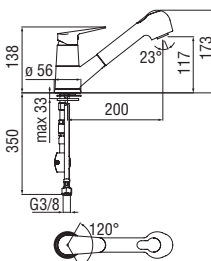

**Monocomando**

- Limitatore di portata con freno al 50%
- Corpo girevole
- Doccetta a 2 getti estraibile
- Flessibili inox ø 3/8"

Cromo lucido BS101127CR 175,00 €



CARTRIDGE WARRANTY



RCR350 39,00 €

BLUES

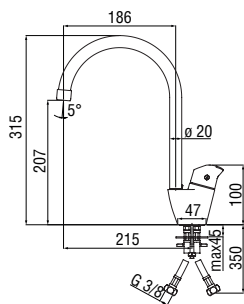

**Monocomando**

- Limitatore di portata con freno al 50%
- Bocca girevole 360°
- Aeratore anticalcare M 22 x 1
- Flessibili inox ø 3/8"

Cromo lucido BS101113CR 103,00 €



CARTRIDGE  
WARRANTY



RCR360/D  
39,00 €



RAEK221/4CR  
45,00 € - 10 pz.

ABC

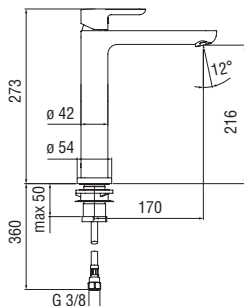

**Monocomando**

- Limitatore di portata con freno al 50%
- Corpo girevole
- Aeratore anticalcare M 24 x 1
- Flessibili inox ø 3/8"

Cromo lucido AB87713CR 244,00 €



CARTRIDGE  
WARRANTY



RCR350/D  
39,00 €



RAEK220/32CR  
45,00 € - 10 pz.

NOBI

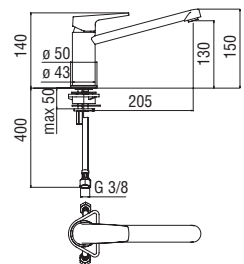

**Monocomando**

- Limitatore di portata con freno al 50%
- Corpo girevole 360°
- Aeratore anticalcare M 24 x 1
- Flessibili inox ø 3/8"

Cromo lucido NB84113/25CR 151,00 €



CARTRIDGE  
WARRANTY



RCR280/D  
39,00 €



RAEK222/27  
45,00 € - 10 pz.

SAND

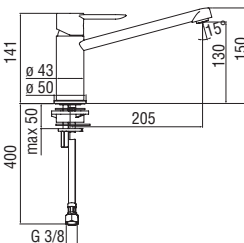

**Monocomando**

- Limitatore di portata con freno al 50%
- Corpo girevole 360°
- Aeratore anticalcare M 24 x 1
- Flessibili inox ø 3/8"

Cromo lucido SA99113/25CR 135,00 €



CARTRIDGE  
WARRANTY



RCR280/D  
39,00 €

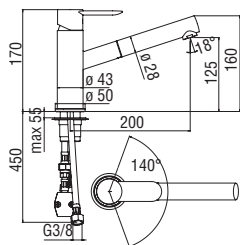

RAEK222/27  
45,00 € - 10 pz.

**Monocomando**

- Limitatore di portata con freno al 50%
- Corpo girevole
- Doccetta monogetto estraibile
- Flessibili inox  $\varnothing$  3/8"

Cromo lucido

SA99117CR

177,00 €

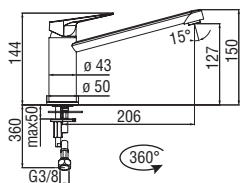
CARTRIDGE  
WARRANTYRCR350  
39,00 €**Monocomando**

- Limitatore di portata con freno al 50%
- Corpo girevole 360°
- Aeratore anticalcare M 24 x 1
- Flessibili inox  $\varnothing$  3/8"

Cromo lucido

SY97113/25CR

114,00 €

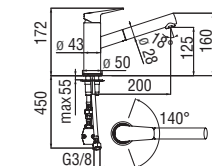
CARTRIDGE  
WARRANTYRCR280/D  
39,00 €RAEK222/27  
45,00 € - 10 pz.**Monocomando**

- Limitatore di portata con freno al 50%
- Corpo girevole
- Doccetta monogetto estraibile
- Flessibili inox  $\varnothing$  3/8"

Cromo lucido

SY97117CR

193,00 €

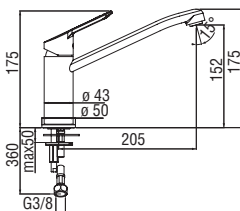
CARTRIDGE  
WARRANTYRCR350  
39,00 €**Monocomando a risparmio energetico**

- Limitatore di energia con apertura in acqua fredda
- Limitatore di portata con freno al 50%
- Corpo girevole 360°
- Aeratore anticalcare M 24 x 1
- Flessibili inox  $\varnothing$  3/8"

Cromo lucido

RDE0113/25CR

146,00 €

CARTRIDGE  
WARRANTYRCR280/D  
39,00 €RAEK222/27  
45,00 € - 10 pz.

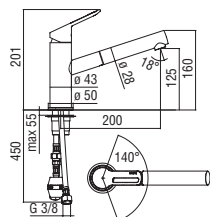

**Monocomando**

- Limitatore di portata con freno al 50%
- Corpo girevole
- Doccetta monogetto estraibile
- Flessibili inox ø 3/8"

Cromo lucido RDO0117CR 183,00 €



CARTRIDGE WARRANTY



RCR350 39,00 €

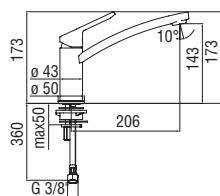

**Monocomando a risparmio energetico**

- Limitatore di energia con apertura in acqua fredda
- Limitatore di portata con freno al 50%
- Corpo girevole 360°
- Aeratore anticalcare M 24 x 1
- Aeratore 5 l/min incluso nella confezione
- Flessibili inox ø 3/8"

Cromo lucido RDE0113/27T7CR 159,00 €



CARTRIDGE WARRANTY



RCR280/D 39,00 €



RAEK220/32CR 45,00 € - 10 pz.

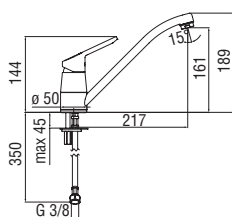

**Monocomando a risparmio energetico**

- Limitatore di energia con apertura in acqua fredda
- Limitatore di portata con freno al 50%
- Corpo girevole 360°
- Aeratore anticalcare M 24 x 1
- Aeratore 5 l/min incluso nella confezione
- Flessibili inox ø 3/8"

Cromo lucido RDE0123/1T7CR 147,00 €



CARTRIDGE WARRANTY



RCR360/D 39,00 €



RAEK220/32CR 45,00 € - 10 pz.

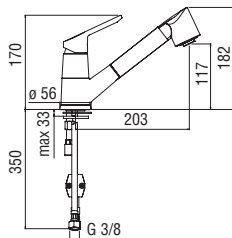

**Monocomando**

- Limitatore di portata con freno al 50%
- Bocca girevole
- Doccetta a 2 getti estraibile
- Flessibili inox ø 3/8"

Cromo lucido RDO0127/1T7CR 191,00 €



CARTRIDGE WARRANTY



RCR350 39,00 €

CUCINA

# SPECIALI

Designers vari

La nostra gamma di miscelatori dotati di caratteristiche tecniche particolari, progettati per migliorare il comfort nei più svariati ambiti d'utilizzo: rubinetti industriali, side spray (con doccetta laterale estraibile), a scomparsa (con bocca in grado di rientrare al di sotto del piano lavello), sottofinestra (con corpo estraibile o bocca abbattibile), bassa pressione, con attacco lavastoviglie, a parete.

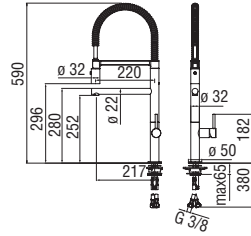

**Monocomando**

- Limitatore di portata con freno al 50%
- Bocca girevole 360°
- Aeratore anticalcare M 18 x 1
- Doccetta monogetto orientabile
- Flessibili inox ø 3/8"

Cromo lucido KL93300/50CR 558,00 €

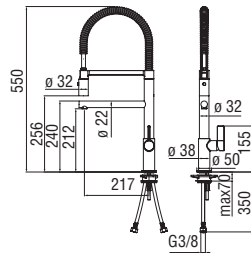
CARTRIDGE  
WARRANTYRCR280/D  
39,00 €RAEK220/27CR  
43,00 € - 10 pz.**Monocomando**

- Limitatore di portata con freno al 50%
- Bocca girevole 360°
- Aeratore anticalcare M 18 x 1
- Doccetta monogetto orientabile
- Flessibili inox ø 3/8"

Cromo lucido FL96300/50CR 603,00 €

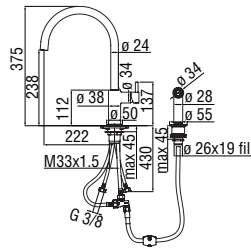
CARTRIDGE  
WARRANTYRCR280/D  
39,00 €RAEK220/27CR  
43,00 € - 10 pz.**Monocomando con doccetta estraibile**

- Bocca girevole 360°
- Doccetta monogetto con pulsante apertura / chiusura
- Flessibili inox ø 3/8"

Cromo lucido CU96600CR 361,00 €

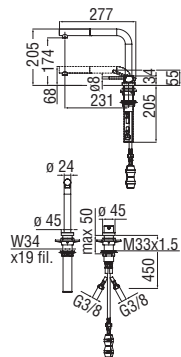
CARTRIDGE  
WARRANTYRCR280/D  
39,00 €RAEK222/26  
45,00 € - 10 pz.**Monocomando con bocca a scomparsa**

- Limitatore di portata con freno al 50%
- Bocca girevole 360°
- Doccetta monogetto estraibile
- Flessibili inox ø 3/8"

Cromo lucido AQ93500CR 473,00 €

Inox spazzolato AQ93500IX 710,00 €

CARTRIDGE  
WARRANTYRCR280/D  
39,00 €



SOTTOFINESTRA / FLAG

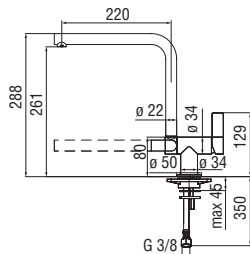

**Monocomando con bocca abbattibile**

- Limitatore di portata con freno al 50%
- Bocca girevole 360°
- Aeratore anticalcare M 18,5 x 1
- Flessibili inox ø 3/8"

Cromo lucido	FL96114CR	373,00 €
Inox spazzolato	FL96114IX	559,00 €



CARTRIDGE  
WARRANTY



RCR280/D  
39,00 €



RAEK220/27CR  
43,00 € - 10 pz.

SOTTOFINESTRA / MIA

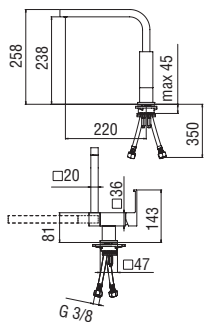

**Monocomando con bocca abbattibile**

- Limitatore di portata con freno al 50%
- Bocca girevole 360°
- Aeratore anticalcare M 24 x 1
- Flessibili inox ø 3/8"

Cromo lucido	MII02114CR	501,00 €
--------------	------------	----------



CARTRIDGE  
WARRANTY



RCR280/D  
39,00 €



RAEK222/20  
58,00 € - 10 pz.

SOTTOFINESTRA / OVETTO

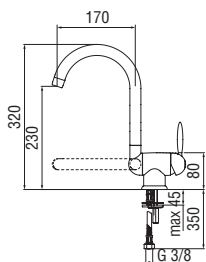

**Monocomando con bocca abbattibile**

- Bocca girevole 360°
- Aeratore anticalcare M 22 x 1
- Flessibili inox ø 3/8"

Cromo lucido	NUI2513/4CR	332,00 €
--------------	-------------	----------



RCR440  
39,00 €



RAEK221/4CR  
45,00 € - 10 pz.

SOTTOFINESTRA / ANTICA

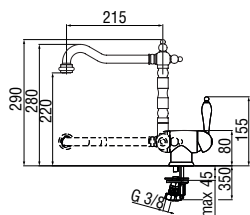

**Monocomando con bocca abbattibile**

- Bocca girevole 360°
- Aeratore anticalcare M 22 x 1
- Flessibili inox ø 3/8"

Cromo lucido	AT18513/4CR	435,00 €
Caffè spazzolato	AT18513/4SB	<b>NEW</b> 696,00 €
Argilla spazzolato PVD	AT18513/4RTP	<b>NEW</b> 696,00 €



RCR440  
39,00 €



RAE219/47CR  
23,00 € - 1 pz.



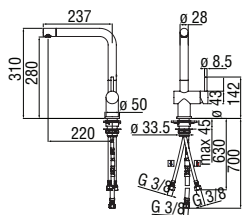

**Monocomando bassa pressione**

- Limitatore di portata con freno al 50%
- Bocca girevole
- Aeratore anticalcare M 24 x 1
- Flessibili inox ø 3/8"

Cromo lucido BPLV113CR 332,00 €



CARTRIDGE  
WARRANTY



RCR350  
39,00 €

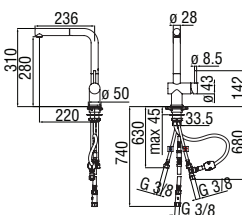

**Monocomando bassa pressione**

- Limitatore di portata con freno al 50%
- Bocca girevole
- Doccetta monogetto estraibile
- Flessibili inox ø 3/8"

Cromo lucido BPLV117/1CR 365,00 €



CARTRIDGE  
WARRANTY



RCR350  
39,00 €

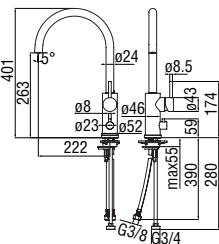

**Monocomando con attacco lavastoviglie**

- Limitatore di portata con freno al 50%
- Bocca girevole 360°
- Aeratore anticalcare M 21,5 x 1
- Flessibili inox ø 3/8"

Cromo lucido LV00113/10CR 318,00 €



CARTRIDGE  
WARRANTY



RCR350  
39,00 €



RAEK222/26  
45,00 € - 10 pz.

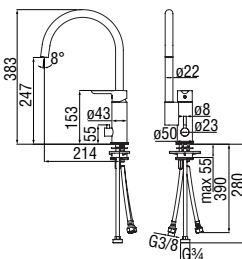

**Monocomando con attacco lavastoviglie**

- Limitatore di portata con freno al 50%
- Bocca girevole 360°
- Aeratore anticalcare M 18,5 x 1
- Flessibili inox ø 3/8"

Cromo lucido AB87133/10CR 258,00 €



CARTRIDGE  
WARRANTY



RCR350  
39,00 €



RAEK222/23  
43,00 € - 10 pz.

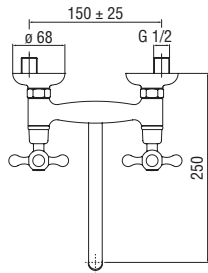

**Bicomando a parete**

- Bocca girevole

Cromo lucido GRC5003CR 190,00 €



RVT200/5D  
18,00 €



RAEK219/63CR  
53,00 € - 10 pz.

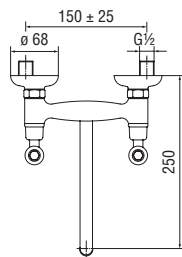

**Bicomando a parete**

- Bocca girevole
- Aeratore anticalcare M 22 x 1

Cromo lucido AT31003CR 255,00 €

Caffè spazzolato AT31003SB **NEW** 408,00 €

Argilla spazzolato PVD AT31003RTP **NEW** 408,00 €



RVT200/5S  
18,00 €



RVT200/5D  
18,00 €



RAEK219/63CR  
53,00 € - 10 pz.

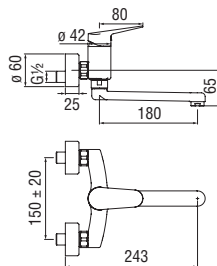

**Monocomando a parete**

- Limitatore di portata con freno al 50%
- Bocca girevole
- Aeratore anticalcare M 22 x 1

Cromo lucido BS101115CR 151,00 €



CARTRIDGE  
WARRANTY



RCR350  
39,00 €



RAEK220/32CR  
45,00 € - 10 pz.

ACCESSORI

# DISPENSER SAPONE

Centro Stile Nobili

Il dispenser sapone professionale è l'accessorio perfetto per mantenere ordinato il piano lavello: utile ed ergonomico, può essere utilizzato facilmente anche con una sola mano. Profili eclettici dai tratti morbidi oppure più decisi: indipendentemente dal modello, una visione completa dello spazio cucina, in grado di affiancarsi con armonia e coerenza alle diverse linee dei miscelatori.



Cromo lucido



Inox spazzolato



Grafite spazzolato PVD



Mora opaco



Ambra spazzolato PVD



Argilla spazzolato PVD

## Dispenser sapone a incasso

· Capacità 300 ml

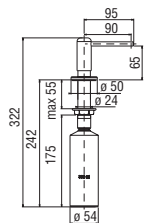

Cromo lucido	AVP3534CR		120,00 €
Inox spazzolato	AVP3534IX		180,00 €
Grafite spazzolato PVD	AVP3534GUP	<b>NEW</b>	192,00 €
Mora opaco	AVP3534BM		180,00 €
Ambra spazzolato PVD	AVP3534GTP	<b>NEW</b>	192,00 €
Argilla spazzolato PVD	AVP3534RTP	<b>NEW</b>	192,00 €

## Dispenser sapone a incasso

· Capacità 300 ml

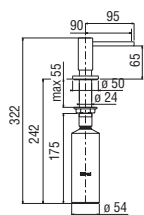

Cromo lucido	AVP3536CR		147,00 €
--------------	-----------	--	----------

## ARTICOLI VARI

Varietà estetica e funzionale: un'ampia sezione di articoli utili al completamento del progetto architettonico o dello spazio espositivo, suddivisa per singole tipologie in modo da facilitarne e velocizzarne la ricerca, e in grado di interpretarne al meglio le esigenze stilistiche e pratiche.





## AUSILI SANITARI

LEVA CLINICA	485
TEMPORIZZATI	488
INFRAROSSI	489
DOCCIA WC	492
IDROSCOPINI	492

## COMPLEMENTI

SCARICHI	495
SIFONI	496
BOCCHIE A PARETE	499
FILTRI	502
PLACCHE WC <b>NEW</b>	503
RUBINETTI D'ARRESTO	504
ECCENTRICI	504
VARI	505

## COMPONENTI BORDO VASCA

COMANDI	511
BOCCHIE	514
DEVIATORI	516
SET DOCCIA	519
ACCESSORI	520

## CANALINE DOCCIA

PARTE INCASSO	523
PARTE ESTERNA	523
ACCESSORI	525

## SALA MOSTRA

ESPOSITORI	529
BOX	533

ARTICOLI VARI

# AUSILI SANITARI

Centro Stile Nobili

Massima ergonomia dedicata alla comunità e alle persone con mobilità ridotta, dove affidabilità e tecnologia rivestono un ruolo di primo piano per garantire una semplicità e praticità d'utilizzo senza paragoni. Un'offerta completa che soddisfa le esigenze dell'ambiente bagno e cucina, implementata dalle proposte infrarossi, particolarmente indicate per gli spazi pubblici.

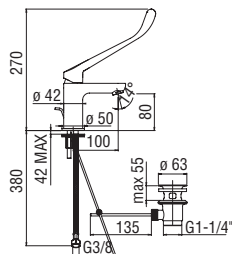

**Monocomando**

- Aeratore anticalcare M 24 x 1
- Scarico 1 1/4" con sistema brevettato SNAP
- Flessibili inox ø 3/8"

Cromo lucido AS87118/1CCR 177,00 €

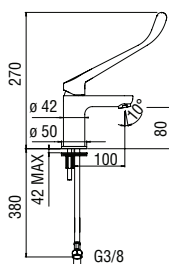
CARTRIDGE  
WARRANTYRCR350/DCL  
39,00 €RAEK220/32CR  
45,00 € - 10 pz.**Monocomando**

- Aeratore anticalcare M 24 x 1
- Senza scarico
- Flessibili inox ø 3/8"

Cromo lucido AS87118/2CCR 167,00 €

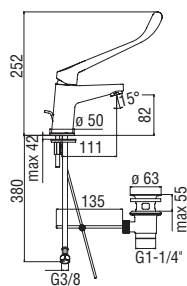
CARTRIDGE  
WARRANTYRCR350/DCL  
39,00 €RAEK220/32CR  
45,00 € - 10 pz.**Monocomando**

- Aeratore anticalcare M 24 x 1
- Scarico 1 1/4" con sistema brevettato SNAP
- Flessibili inox ø 3/8"

Cromo lucido AS84118/1CCR 184,00 €

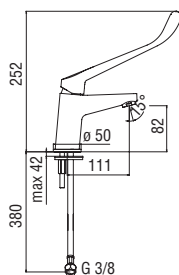
CARTRIDGE  
WARRANTYRCR350/DCL  
39,00 €RAEK220/32CR  
45,00 € - 10 pz.**Monocomando**

- Aeratore anticalcare M 24 x 1
- Senza scarico
- Flessibili inox ø 3/8"

Cromo lucido AS84118/2CCR 172,00 €

CARTRIDGE  
WARRANTYRCR350/DCL  
39,00 €RAEK220/32CR  
45,00 € - 10 pz.

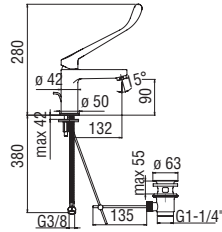

**Monocomando**

- Aeratore anticalcare M 24 x 1
- Scarico 1 1/4" con sistema brevettato SNAP
- Flessibili inox  $\varnothing$  3/8"

Cromo lucido ASRD118/1CCR 198,00 €

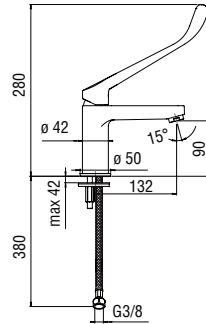
CARTRIDGE  
WARRANTYRCR350/DCL  
39,00 €RAEK220/32CR  
45,00 € - 10 pz.**Monocomando**

- Aeratore anticalcare M 24 x 1
- Senza scarico
- Flessibili inox  $\varnothing$  3/8"

Cromo lucido ASRD118/2CCR 185,00 €

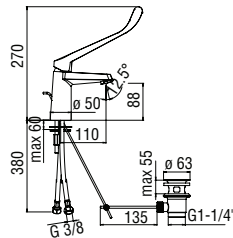
CARTRIDGE  
WARRANTYRCR350/DCL  
39,00 €RAEK220/32CR  
45,00 € - 10 pz.**Monocomando**

- Aeratore anticalcare M 24 x 1
- Scarico 1 1/4" con sistema brevettato SNAP
- Flessibili inox  $\varnothing$  3/8"

Cromo lucido AS97118/1CCR 198,00 €

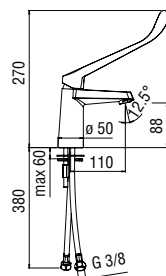
CARTRIDGE  
WARRANTYRCR350/DCL  
39,00 €RAEK220/32CR  
45,00 € - 10 pz.**Monocomando**

- Aeratore anticalcare M 24 x 1
- Senza scarico
- Flessibili inox  $\varnothing$  3/8"

Cromo lucido AS97118/2CCR 185,00 €

CARTRIDGE  
WARRANTYRCR350/DCL  
39,00 €RAEK220/32CR  
45,00 € - 10 pz.

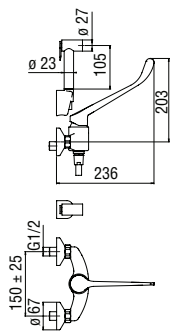
**Monocomando esterno con set doccia**

- Supporto doccetta fisso
- Pulsante apertura / chiusura
- Doccetta monogetto e flessibile 150 cm

Cromo lucido ASRD130/3CCR 322,00 €

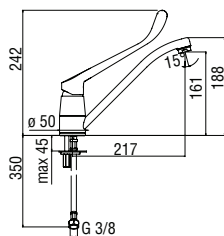
RCR440  
39,00 €**Monocomando con leva clinica**

- Bocca girevole 360°
- Aeratore anticalcare M 24 x 1
- Flessibili inox Ø 3/8"

Cromo lucido ASRD123/1CCR 148,00 €

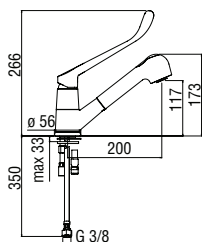
20 YEARS  
CARTRIDGE  
WARRANTYRCR360/DCL  
39,00 €RAEK220/32CR  
45,00 € - 10 pz.**Monocomando con leva clinica**

- Corpo girevole
- Doccetta a 2 getti estraibile
- Flessibili inox Ø 3/8"

Cromo lucido ASRD127/CCR 210,00 €

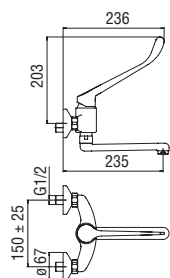
20 YEARS  
CARTRIDGE  
WARRANTYRCR350/DCL  
39,00 €**Monocomando a parete con leva clinica**

- Bocca girevole
- Aeratore anticalcare M 24 x 1

Cromo lucido ASRD115/CCR 191,00 €

RCR440  
39,00 €RAEK220/32CR  
45,00 € - 10 pz.

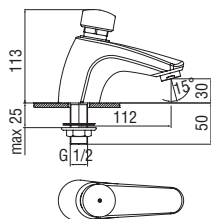

**Rubinetto temporizzato**

- Attacco  $\varnothing$  1/2"
- Comando a pulsante
- Erogazione tarata a 15"
- 5 possibilità di erogazione portata

Cromo lucido AS35200/BCR 102,00 €



RCR35000/B  
44,00 €



RAEK220/32CR  
45,00 € - 10 pz.

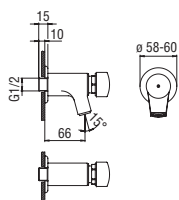

**Rubinetto a parete temporizzato**

- Attacco  $\varnothing$  1/2"
- Comando a pulsante
- Erogazione tarata a 15"
- 5 possibilità di erogazione portata

Cromo lucido AS35300/BCR 69,00 €



RCR35000/B  
44,00 €

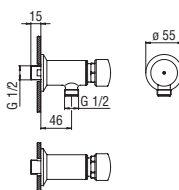

**Rubinetto a parete temporizzato**

- Attacco  $\varnothing$  1/2"
- Comando a pulsante
- Erogazione tarata a 15"
- 5 possibilità di erogazione portata

Cromo lucido AS35400/BCR 69,00 €



RCR35000/B  
44,00 €

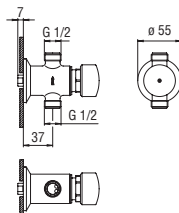

**Rubinetto a parete temporizzato**

- Attacco  $\varnothing$  1/2"
- Comando a pulsante
- Erogazione tarata a 15"
- 5 possibilità di erogazione portata

Cromo lucido AS35500/VCR 65,00 €



RCR35000/V  
44,00 €

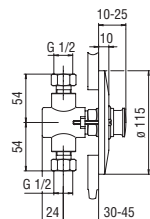

**Rubinetto a incasso temporizzato**

- Attacco ø 1/2"
- Comando a pulsante
- Erogazione tarata a 6"
- Parte esterna e parte incasso

Cromo lucido	AS35600CR	128,00 €
--------------	-----------	----------



RVT200/31  
74,00 €

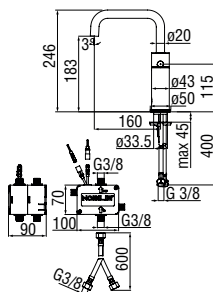

**Comando infrarossi**

- Aeratore anticalcare M 18 x 1, portata 5 l/min
- Bocca girevole
- Alimentazione a batteria
- Senza scarico, flessibili inox ø 3/8"

Cromo lucido	IRVE125118/3CR	463,00 €
Inox spazzolato	IRVE125118/3IX	695,00 €
Grafite spazzolato PVD	IRVE125118/3GUP	741,00 €
Miele spazzolato PVD	IRVE125118/3CGP	<b>NEW</b> 741,00 €
Caffè spazzolato	IRVE125118/3SB	<b>NEW</b> 741,00 €
Tramonto lucido PVD	IRVE125118/3RCP	741,00 €
Argilla spazzolato PVD	IRVE125118/3RTP	741,00 €



RAEK222/42  
45,00 € - 10 pz.

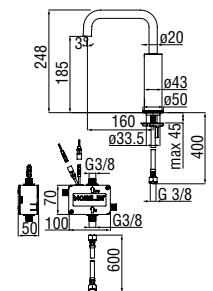

**Comando infrarossi monoacqua**

- Aeratore anticalcare M 18 x 1, portata 5 l/min
- Alimentazione a batteria
- Senza scarico, flessibili inox ø 3/8"

Cromo lucido	IRVE125236CR	419,00 €
Inox spazzolato	IRVE125236IX	629,00 €
Grafite spazzolato PVD	IRVE125236GUP	670,00 €
Miele spazzolato PVD	IRVE125236CGP	<b>NEW</b> 670,00 €
Caffè spazzolato	IRVE125236SB	<b>NEW</b> 670,00 €
Tramonto lucido PVD	IRVE125236RCP	670,00 €
Argilla spazzolato PVD	IRVE125236RTP	670,00 €



RAEK222/42  
45,00 € - 10 pz.

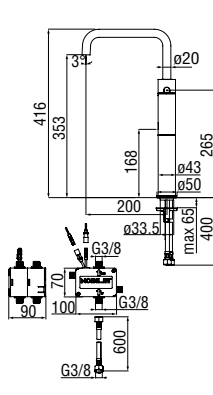

**Comando infrarossi a bacinella**

- Aeratore anticalcare M 18 x 1, portata 5 l/min
- Bocca girevole
- Alimentazione a batteria
- Senza scarico, flessibili inox ø 3/8"

Cromo lucido	IRVE125128/3CR	529,00 €
Inox spazzolato	IRVE125128/3IX	794,00 €
Grafite spazzolato PVD	IRVE125128/3GUP	846,00 €
Miele spazzolato PVD	IRVE125128/3CGP	<b>NEW</b> 846,00 €
Caffè spazzolato	IRVE125128/3SB	<b>NEW</b> 846,00 €
Tramonto lucido PVD	IRVE125128/3RCP	846,00 €
Argilla spazzolato PVD	IRVE125128/3RTP	846,00 €



RAEK222/42  
45,00 € - 10 pz.

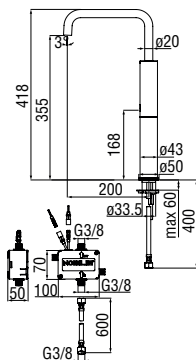

**Comando infrarossi monoacqua a bacinella**

- Aeratore anticalcare M 18 x 1, portata 5 l/min
- Alimentazione a batteria
- Senza scarico, flessibili inox ø 3/8"

Cromo lucido	IRVE125238CR	463,00 €
Inox spazzolato	IRVE125238IX	695,00 €
Grafite spazzolato PVD	IRVE125238GUP	741,00 €
Miele spazzolato PVD	IRVE125238CGP	<b>NEW</b> 741,00 €
Caffè spazzolato	IRVE125238SB	<b>NEW</b> 741,00 €
Tramonto lucido PVD	IRVE125238RCP	741,00 €
Argilla spazzolato PVD	IRVE125238RTP	741,00 €

RAEK222/42  
45,00 € - 10 pz.

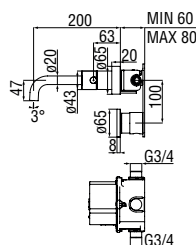

**Comando infrarossi a parete**

- Aeratore anticalcare M 18 x 1, portata 5 l/min
- Lunghezza bocca 200 mm
- Alimentazione a batteria
- Senza scarico

Cromo lucido	IRVE125198/1CR	938,00 €
Inox spazzolato	IRVE125198/1IX	1.406,00 €
Grafite spazzolato PVD	IRVE125198/1GUP	1.499,00 €
Miele spazzolato PVD	IRVE125198/1CGP	<b>NEW</b> 1.499,00 €
Caffè spazzolato	IRVE125198/1SB	<b>NEW</b> 1.499,00 €
Tramonto lucido PVD	IRVE125198/1RCP	1.499,00 €
Argilla spazzolato PVD	IRVE125198/1RTP	1.499,00 €

RAEK222/42 45,00 € - 10 pz.      NR00212/33 41,00 €

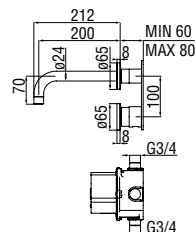

**Comando infrarossi monoacqua a parete**

- Aeratore anticalcare M 22 x 1
- Lunghezza 200 mm
- Alimentazione a batteria
- Senza scarico

Cromo lucido	IRAV00158/TCR	860,00 €
Inox spazzolato	IRAV00158/TIX	1.290,00 €
Grafite spazzolato PVD	IRAV00158/TGUP	1.376,00 €
Miele spazzolato PVD	IRAV00158/TCGP	<b>NEW</b> 1.376,00 €
Caffè spazzolato	IRAV00158/TSB	<b>NEW</b> 1.376,00 €
Tramonto lucido PVD	IRAV00158/TRCP	1.376,00 €
Argilla spazzolato PVD	IRAV00158/TRTP	1.376,00 €

RAEK220/36CR  
53,00 € - 10 pz.

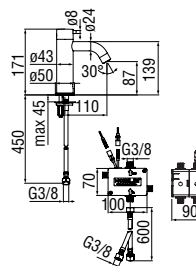

**Comando infrarossi**

- Aeratore anticalcare M 22 x 1
- Alimentazione a batteria
- Senza scarico
- Flessibili inox ø 3/8"

Cromo lucido	IRLV00118/3CR	455,00 €
--------------	---------------	----------

RAEK219/67CR  
75,00 € - 10 pz.

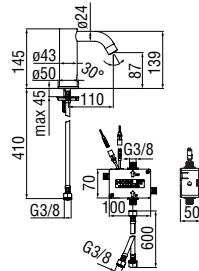

**Comando infrarossi monoacqua**

- Aeratore anticalcare M 22 x 1
- Alimentazione a batteria
- Senza scarico
- Flessibili inox ø 3/8"

Cromo lucido IRLV00236CR 400,00 €

RAEK219/67CR  
75,00 € - 10 pz.

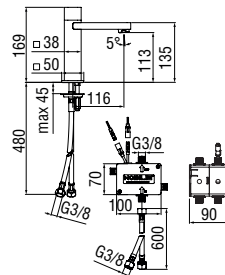

**Comando infrarossi**

- Aeratore anticalcare M 24 x 1
- Alimentazione a batteria
- Senza scarico
- Flessibili inox ø 3/8"

Cromo lucido IRLP90118/3CR 501,00 €

RAEK219/23CR  
61,00 € - 10 pz.

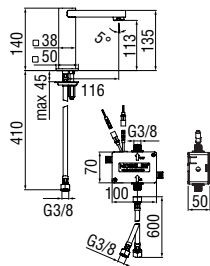

**Comando infrarossi monoacqua**

- Aeratore anticalcare M 24 x 1
- Alimentazione a batteria
- Senza scarico
- Flessibili inox ø 3/8"

Cromo lucido IRLP90236CR 450,00 €

RAEK219/23CR  
61,00 € - 10 pz.

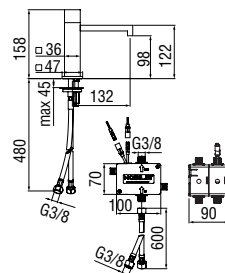

**Comando infrarossi**

- Aeratore anticalcare
- Alimentazione a batteria
- Senza scarico
- Flessibili inox ø 3/8"

Cromo lucido IRMI02118/3CR 561,00 €

RAEK222/28  
93,00 € - 5 pz.

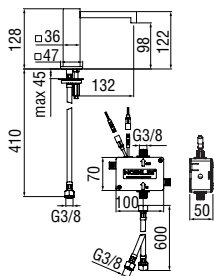

**Comando infrarossi monoacqua**

- Aeratore anticalcare
- Alimentazione a batteria
- Senza scarico
- Flessibili inox  $\varnothing$  3/8"

Cromo lucido IRM1102236CR 509,00 €



RAEK222/28  
93,00 € - 5 pz.

**DOCCIA WC**

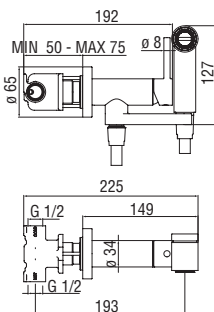

**Monocomando incasso**

- Doccetta monogetto con pulsante apertura / chiusura
- Flessibile 100 cm

Cromo lucido	AV00600CR	281,00 €
Inox spazzolato	AV00600IX	421,00 €
Grafite spazzolato PVD	AV00600GUP	449,00 €
Mora opaco	AV00600BM	421,00 €
Miele spazzolato PVD	AV00600CGP	NEW 449,00 €
Caffè spazzolato	AV00600SB	NEW 449,00 €
Tramonto lucido PVD	AV00600RCP	449,00 €
Argilla spazzolato PVD	AV00600RTP	449,00 €



CARTRIDGE  
WARRANTY



RCR280/D  
39,00 €



NR00212/25  
43,00 €

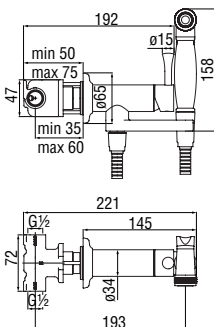

**Monocomando incasso**

- Doccetta monogetto con pulsante apertura / chiusura
- Flessibile 100 cm

Cromo lucido	AV00610CR	351,00 €
Miele spazzolato PVD	AV00610CGP	NEW 562,00 €
Caffè spazzolato	AV00610SB	NEW 562,00 €



CARTRIDGE  
WARRANTY



RCR280/D  
39,00 €



NR00212/25  
43,00 €

**IDROSCOPINI**

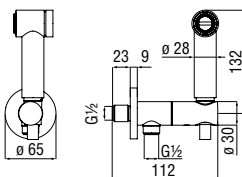

**Set wc con presa acqua  $\varnothing$  1/2"**

- Doccetta monogetto con pulsante apertura / chiusura
- Flessibile 100 cm

Cromo lucido	AV00601CR	NEW	180,00 €
Inox spazzolato	AV00601IX	NEW	270,00 €
Grafite spazzolato PVD	AV00601GUP	NEW	288,00 €
Mora opaco	AV00601BM	NEW	270,00 €
Miele spazzolato PVD	AV00601CGP	NEW	288,00 €
Caffè spazzolato	AV00601SB	NEW	288,00 €
Tramonto lucido PVD	AV00601RCP	NEW	288,00 €
Argilla spazzolato PVD	AV00601RTP	NEW	288,00 €

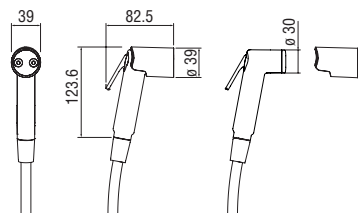

**Set wc**

- Supporto doccetta fisso
- Doccetta monogetto con pulsante apertura / chiusura
- Flessibile 120 cm

Cromo lucido	AD146/51CR	57,00 €
Mora opaco	AD146/51BM	110,00 €

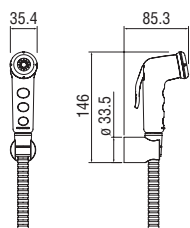

**Set wc**

- Supporto doccetta fisso
- Doccetta monogetto con pulsante apertura / chiusura
- Flessibile 120 cm

Cromo lucido	AD146/52CR	42,00 €
Cromo l. e Neve o.	AD146/52BB	36,00 €



ARTICOLI VARI

# COMPLEMENTI

Centro Stile Nobili

La nostra visione esprime una razionalità a 360°, dove è viva la consapevolezza che ogni elemento contribuisce nella creazione di un ambiente coerente. Ogni dettaglio è fondamentale, scarichi, sifoni, bocche a parete, filtri, rubinetti d'arresto, eccentrici e altri articoli complementari: nulla è lasciato al caso per realizzare ambienti armonici ed eleganti.



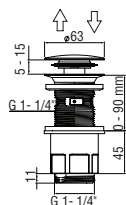

**Scarico 1 1/4" push universale**

- In plastica
- Tagliabile
- Senza troppo pieno o con troppo pieno

Cromo lucido	AV00110/3CR	26,00 €
Mora opaco	AV00110/3BM	<b>NEW</b> 39,00 €

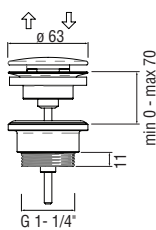

**Scarico 1 1/4" push universale in ottone**

- Senza troppo pieno o con troppo pieno

Cromo lucido	AV00110/11CR	63,00 €
Inox spazzolato	AV00110/11IX	95,00 €
Grafite spazzolato PVD	AV00110/11GUP	101,00 €
Mora opaco	AV00110/11BM	95,00 €
Neve opaco	AV00110/11WM	95,00 €
Miele spazzolato PVD	AV00110/11CGP	<b>NEW</b> 101,00 €
Caffè spazzolato	AV00110/11SB	<b>NEW</b> 101,00 €
Tramonto lucido PVD	AV00110/11RCP	101,00 €
Argilla spazzolato PVD	AV00110/11RTP	101,00 €

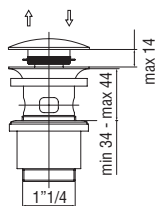

**Scarico 1 1/4" push**

- In plastica
- Con troppo pieno

Cromo lucido	AV00110/2CR	22,00 €
--------------	-------------	---------

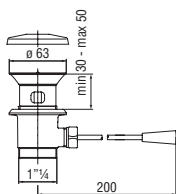

**Scarico 1 1/4"**

- Comando a leva

Cromo lucido	AV00224/3CR	30,00 €
--------------	-------------	---------

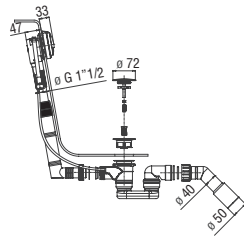

**Colonna vasca con erogazione**

- Getto cascata
- Comando a pressione
- Terminale ø 72 mm in ABS
- Tubo di troppo pieno flessibile
- Sifone ribassato orientabile ø 40 - 50 mm

Cromo lucido AV00101/51CR 145,00 €

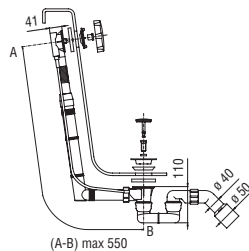

**Colonna vasca**

- Movimento a cremagliera
- Sifone ribassato in ABS
- Terminale in PP ø 40 - 50 mm
- Tubo di troppo pieno "flex-top"

Cromo lucido AV00100/50CR 60,00 €

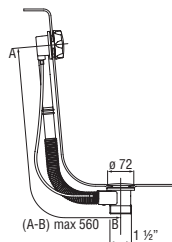

**Colonna vasca**

- Movimento "direct"

Cromo lucido AV00100/10CR 64,00 €

SIFONI

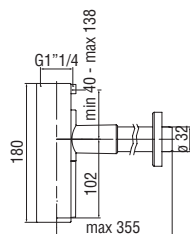

**Sifone**

- Attacco ø 1 1/4"
- Regolabile, senza piletta

Cromo lucido	AV00107/10CR	206,00 €
Inox spazzolato	AV00107/10IX	309,00 €
Grafite spazzolato PVD	AV00107/10GUP	330,00 €
Mora opaco	AV00107/10BM	309,00 €
Neve opaco	AV00107/10WM	309,00 €
Miele spazzolato PVD	AV00107/10CGP	<b>NEW</b> 330,00 €
Caffè spazzolato	AV00107/10SB	<b>NEW</b> 330,00 €
Tramonto lucido PVD	AV00107/10RCP	330,00 €
Argilla spazzolato PVD	AV00107/10RTP	330,00 €

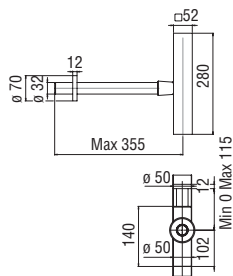
**Sifone**

- Attacco  $\varnothing$  1 1/4"
- Regolabile
- Senza piletta

Cromo lucido	AV00102/3CR	232,00 €
Inox spazzolato	AV00102/3IX	349,00 €
Mora opaco	AV00102/3BM	349,00 €

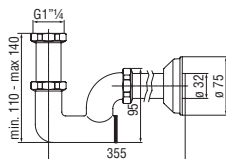
**Sifone**

- Attacco  $\varnothing$  1 1/4"
- Con ispezione
- Senza piletta

Cromo lucido	AV00107/1CR	43,00 €
Miele spazzolato PVD	AV00107/1CGP	<b>NEW</b> 69,00 €
Caffè spazzolato	AV00107/1SB	<b>NEW</b> 69,00 €

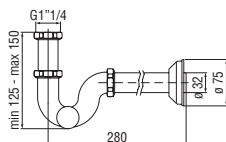
**Sifone**

- Attacco  $\varnothing$  1 1/4"
- Regolabile
- Senza piletta

Cromo lucido	AV00105/2CR	30,00 €
--------------	-------------	---------

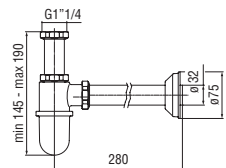
**Sifone**

- Attacco  $\varnothing$  1 1/4"
- Regolabile
- Senza piletta

Cromo lucido	AV00103/2CR	30,00 €
--------------	-------------	---------

**Sifone per piatto doccia**

- Completamente ispezionabile
- Foro  $\varnothing$  90 mm
- Tappo di copertura in ABS

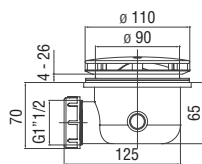

Cromo lucido	AV00111/13CR	24,00 €
Caffè spazzolato	AV00111/13SB	<b>NEW</b> 38,00 €

**Sifone per piatto doccia**

- Completamente ispezionabile
- Foro  $\varnothing$  90 mm
- Tappo di copertura in ABS
- Conforme alla norma UNI EN 329

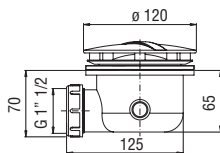

Cromo lucido	AV00111/11CR	26,00 €
--------------	--------------	---------

**Sifone per piatto doccia**

- Completamente ispezionabile
- Foro  $\varnothing$  60 mm
- Tappo di copertura in ABS

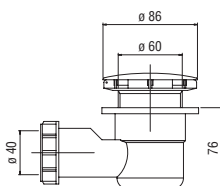

Cromo lucido	AV00111/10CR	24,00 €
--------------	--------------	---------

**Sifone per piatto doccia**

- Completamente ispezionabile
- Foro  $\varnothing$  60 mm
- Tappo di copertura in ABS

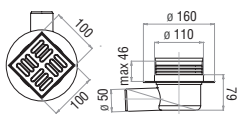

Cromo lucido	AV00111/20CR	27,00 €
--------------	--------------	---------

**Sifone per piatto doccia**

· In ottone

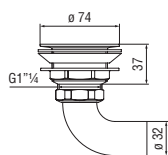

Cromo lucido	AV00111/1CR	39,00 €
--------------	-------------	---------

**Sifone ribassato**

· Terminale in PP ø 40 - 50 mm

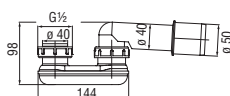

-	AV00109/3CR	16,00 €
---	-------------	---------

## BOCCHIE A PARETE

**Bocca a parete**

· Aeratore anticalcare M 24 x 1

· Lunghezza 200 mm

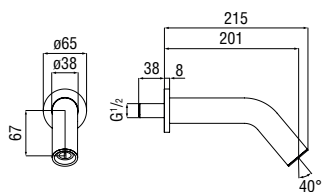

Inox spazzolato	AV00158/54DIX	<b>NEW</b>	291,00 €
Grafite spazzolato PVD	AV00158/54DGP	<b>NEW</b>	310,00 €
Caffè spazzolato	AV00158/54DSB	<b>NEW</b>	310,00 €
Argilla spazzolato PVD	AV00158/54DRTP	<b>NEW</b>	310,00 €
Cromo lucido	AV00158/54DCR	<b>NEW</b>	194,00 €



RAEK222/22  
45,00 € - 10 pz.

**Bocca a parete**

· Aeratore anticalcare M 22 x 1

· Lunghezza 200 mm

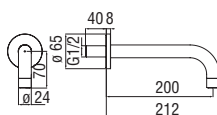

Cromo lucido	AV00158/36CR	103,00 €
Inox spazzolato	AV00158/36IX	155,00 €
Grafite spazzolato PVD	AV00158/36GUP	164,00 €
Mora opaco	AV00158/36BM	155,00 €
Neve opaco	AV00158/36WM	155,00 €
Miele spazzolato PVD	AV00158/36CGP	<b>NEW</b> 164,00 €
Caffè spazzolato	AV00158/36SB	<b>NEW</b> 164,00 €
Tramonto lucido PVD	AV00158/36RCP	164,00 €
Argilla spazzolato PVD	AV00158/36RTP	164,00 €



RAEK220/36CR  
53,00 € - 10 pz.

**Bocca a parete**

- Aeratore anticalcare M 24 x 1
- Lunghezza 200 mm

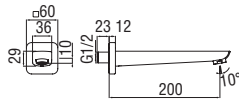

Cromo lucido	AV00158/40CR	191,00 €
Mora opaco	AV00158/40BM	287,00 €



RAEK220/14CR  
45,00 € - 10 pz.

**Bocca a parete**

- Aeratore anticalcare M 28 x 1
- Lunghezza 240 mm

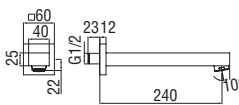

Cromo lucido	AV00158/38CR	180,00 €
Inox spazzolato	AV00158/38IX	269,00 €
Mora opaco	AV00158/38BM	269,00 €



RAEK219/41CR  
47,00 € - 5 pz.

**Bocca a parete**

- Aeratore anticalcare M 24 x 1
- Lunghezza 200 mm

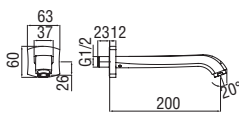

Cromo lucido	AV00158/41CR	182,00 €
Caffè spazzolato	AV00158/41SB	<b>NEW</b> 291,00 €



RAEK220/14CR  
45,00 € - 10 pz.

**Bocca a parete**

- Aeratore anticalcare M 28 x 1

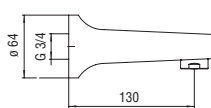

Cromo lucido	AV00159CR	57,00 €
--------------	-----------	---------

**Bocca a parete**

· Aeratore anticalcare M 28 x 1

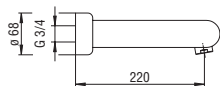

Cromo lucido AV00159/2CR 139,00 €



RAEK219/4CR  
43,00 € - 5 pz.

**Bocca a parete**

· Aeratore anticalcare M 28 x 1



Cromo lucido AV00159/1CR 139,00 €

Tramonto lucido PVD AV00159/1RCP 223,00 €



RAEK219/4CR  
43,00 € - 5 pz.

**Bocca a parete**

· Aeratore anticalcare M 22 x 1

· Deviatore con ritorno automatico

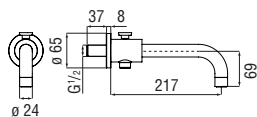

Cromo lucido AV00158/52CR **NEW** 200,00 €

Inox spazzolato AV00158/52IX **NEW** 300,00 €

Grafite spazzolato PVD AV00158/52GUP **NEW** 320,00 €

Mora opaco AV00158/52BM **NEW** 300,00 €

Neve opaco AV00158/52WM **NEW** 300,00 €

Miele spazzolato PVD AV00158/52CGP **NEW** 320,00 €

Caffè spazzolato AV00158/52SB **NEW** 320,00 €

Tramonto lucido PVD AV00158/52RCP **NEW** 320,00 €

Argilla spazzolato PVD AV00158/52RTP **NEW** 320,00 €



RAEK220/36CR  
53,00 € - 10 pz.

**Bocca a parete**

· Aeratore anticalcare M 28 x 1

· Deviatore con ritorno automatico

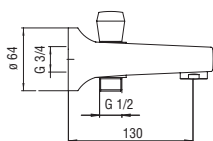

Cromo lucido AV00158CR 75,00 €



RAEK219/4CR  
43,00 € - 5 pz.



**Bocca lavapiedi**

- Aeratore anticalcare M 24 x 1
- Getto orientabile

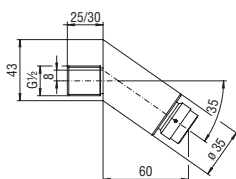

Cromo lucido AV00156/4CR 131,00 €



RAEK220/37CR  
47,00 € - 10 pz.

**FILTRI**

**Filtro sottolavabo**

- Attacco ø 1/2"

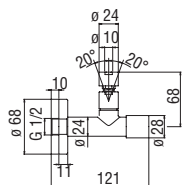

Cromo lucido	AV00121/21CR	63,00 €
Inox spazzolato	AV00121/21IX	95,00 €
Grafite spazzolato PVD	AV00121/21GUP	101,00 €
Mora opaco	AV00121/21BM	95,00 €
Neve opaco	AV00121/21WM	95,00 €
Miele spazzolato PVD	AV00121/21CGP	NEW 101,00 €
Caffè spazzolato	AV00121/21SB	NEW 101,00 €
Tramonto lucido PVD	AV00121/21RCP	101,00 €
Argilla spazzolato PVD	AV00121/21RTP	101,00 €

**Filtro sottolavabo**

- Attacco ø 1/2"

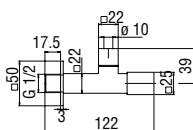

Cromo lucido	AV00121/22CR	76,00 €
Inox spazzolato	AV00121/22IX	114,00 €
Mora opaco	AV00121/22BM	114,00 €

**Filtro sottolavabo**

- Attacco ø 1/2"

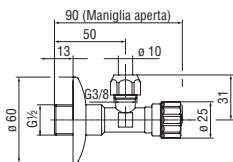

Cromo lucido	AV00121/2CR	24,00 €
Miele spazzolato PVD	AV00121/2CGP	NEW 38,00 €
Caffè spazzolato	AV00121/2SB	NEW 38,00 €

**Filtro sottolavabo**

· Attacco ø 1/2"

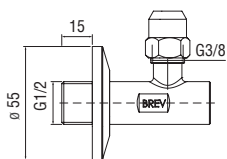

Cromo lucido	AV00121CR		13,00 €
Caffè spazzolato	AV00121SB	<b>NEW</b>	21,00 €

**Filtro sottolavabo**

· Attacco lavatrice ø 3/4"

· Attacco ø 1/2"

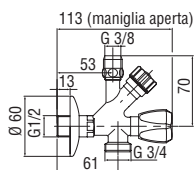

Cromo lucido	AV00121/10CR		43,00 €
--------------	--------------	--	---------

**Sistema d'arresto PRATIKO**

· Dotato di filtri

· Dotato di valvole di non ritorno

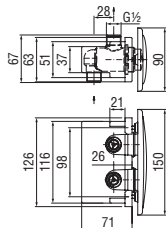

Cromo lucido	AV30910CR		135,00 €
--------------	-----------	--	----------

**PLACCHE WC**

**Placca WC (Inox)**

· Compatibile con Geberit Sigma 8 / Up720 e Sigma 12 / Up320

· Compatibile con TeceBox 8

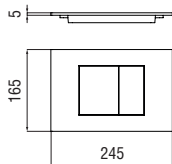

Cromo lucido	AV00300CR	<b>NEW</b>	345,00 €
Inox spazzolato	AV00300IX	<b>NEW</b>	518,00 €
Grafite spazzolato PVD	AV00300GUP	<b>NEW</b>	552,00 €
Mora opaco	AV00300BM	<b>NEW</b>	518,00 €
Miele spazzolato PVD	AV00300CGP	<b>NEW</b>	552,00 €
Caffè spazzolato	AV00300SB	<b>NEW</b>	552,00 €
Tramonto lucido PVD	AV00300RCP	<b>NEW</b>	552,00 €
Argilla spazzolato PVD	AV00300RTP	<b>NEW</b>	552,00 €

**Rubinetto d'arresto**

· 3/4" con cappuccio

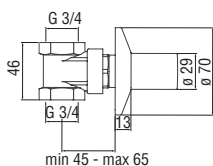

Cromo lucido	AV00155/4CR	44,00 €
Inox spazzolato	AV00155/4IX	66,00 €
Grafite spazzolato PVD	AV00155/4GUP	71,00 €
Mora opaco	AV00155/4BM	66,00 €
Neve opaco	AV00155/4WM	66,00 €
Miele spazzolato PVD	AV00155/4CGP	<b>NEW</b> 71,00 €
Caffè spazzolato	AV00155/4SB	<b>NEW</b> 71,00 €
Tramonto lucido PVD	AV00155/4RCP	71,00 €
Argilla spazzolato PVD	AV00155/4RTP	71,00 €



NR00212/19  
17,00 €

**Rubinetto d'arresto**

· A sfera ø 1/2" con cappuccio

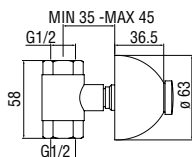

Cromo lucido	AV00155/3CR	27,00 €
--------------	-------------	---------



NR00212/18  
17,00 €

**Rubinetto d'arresto**

· Cappuccio in due pezzi ø 1/2"

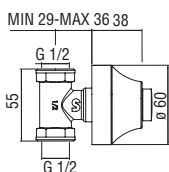

Cromo lucido	AV00155/1CR	22,00 €
Miele spazzolato PVD	AV00155/1CGP	<b>NEW</b> 35,00 €
Caffè spazzolato	AV00155/1SB	<b>NEW</b> 35,00 €



NR00212/18  
17,00 €

**ECCENTRICI**

**Coppia di eccentrici**

· Attacco ø 3/4" x 1/2"

· Fissaggio per vasca

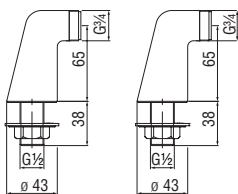

Cromo lucido	AVOK151CR	54,00 €
Mora opaco	AVOK151BM	81,00 €
Caffè spazzolato	AVOK151SB	<b>NEW</b> 86,00 €

ECCENTRICI

**Coppia di eccentrici**

- Attacco  $\varnothing 3/4"$  x  $3/4"$
- Fissaggio per vasca

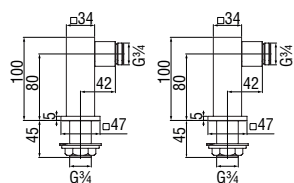

Cromo lucido AVOK151/QCR 229,00 €

VARI

**Raccordo per ristrutturazione**

- Attacco  $\varnothing 3/4"$

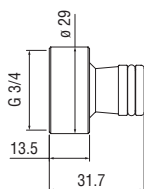

Cromo lucido RNI152/26BCR 15,00 €

**Raccordo**

- Attacco  $\varnothing 1/2"$  x  $3/8"$
- Rosone scorrevole

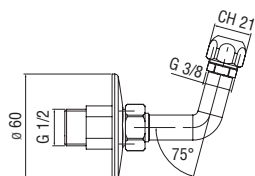

Cromo lucido AV00123CR 13,00 €

**Rubinetto attacco lavatrice**

- A sfera  $\varnothing 1/2"$  x  $3/4"$

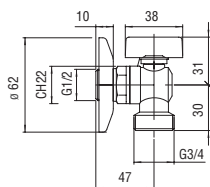

Cromo lucido AV00121/1CR 13,00 €



**Tubo rame**

· Dimensione 350 mm

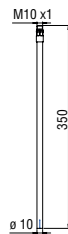

Cromo lucido	NR00202/1CR		14,00 €
Miele spazzolato PVD	NR00202/1CGP	NEW	22,00 €
Caffè spazzolato	NR00202/1SB	NEW	22,00 €



**Tubo per passo rapido esterno**

· Per passo rapido esterno

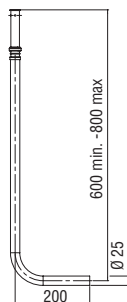

Cromo lucido	AV00115CR		51,00 €
--------------	-----------	--	---------



**Tubo per passo rapido esterno**

· Per passo rapido esterno

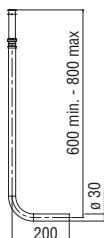

Cromo lucido	AV00115/1CR		56,00 €
--------------	-------------	--	---------

**Copriforo**

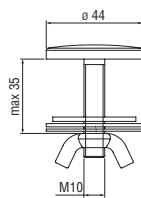

Cromo lucido	AV00124CR		13,00 €
--------------	-----------	--	---------

**Copriforo**

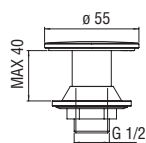

Cromo lucido AV00125CR 19,00 €

**Rubinetto passo rapido esterno**

· Attacco  $\varnothing$  3/4"

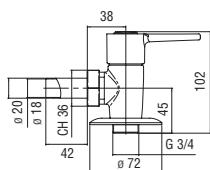

Cromo lucido AV00112CR 45,00 €

**Rubinetto passo rapido a incasso**

· Attacco  $\varnothing$  3/4"

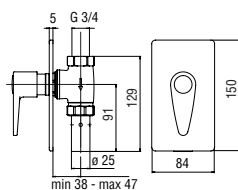

Cromo lucido AV00113CR 85,00 €

 RVT200/30  
30,00 €

 NR00212/20  
39,00 €

**Rubinetto per orinatoio**

· Vitone  $\varnothing$  1/2"

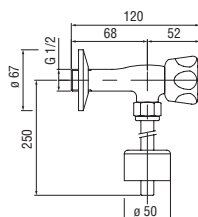

Cromo lucido AV00503CR 43,00 €

**Spartiacque**

· Canotto per vasi alla turca in ghisa

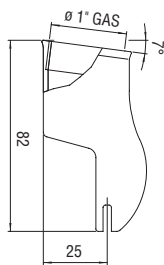

Cromo lucido AV00501CR 21,00 €

**Spartiacque per orinatoio**

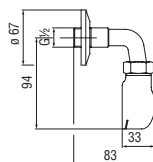

Cromo lucido AV00505CR 27,00 €

**Bicchiere per orinatoio**

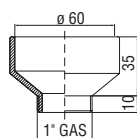

Cromo lucido AV00508CR 29,00 €

**Bicchiere per orinatoio**

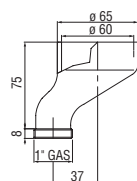

Cromo lucido AV00509CR 29,00 €





ARTICOLI VARI

# COMPONENTI BORDO VASCA

Centro Stile Nobili

La raccolta di componenti per bordo vasca: tecnologia, design e affidabilità al servizio del benessere, nella sua forma migliore e maggiormente rappresentativa. Singoli articoli combinabili tra loro secondo il proprio gusto e con la massima libertà di scelta.



**Miscelatore monocomando**

- Limitatore di portata con freno al 50%
- Ingresso a 2 vie

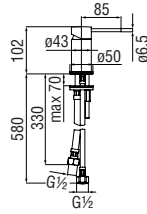

Inox spazzolato	WE00110/9SOIX	<b>NEW</b>	393,00 €
Grafite spazzolato PVD	WE00110/9SOGUP	<b>NEW</b>	419,00 €
Caffè spazzolato	WE00110/9SOSB	<b>NEW</b>	419,00 €
Argilla spazzolato PVD	WE00110/9SORTP	<b>NEW</b>	419,00 €
Cromo lucido	WE00110/9SOCR	<b>NEW</b>	262,00 €



CARTRIDGE  
WARRANTY



RCR350  
39,00 €

**Miscelatore monocomando**

- Limitatore di portata con freno al 50%
- Ingresso a 2 vie

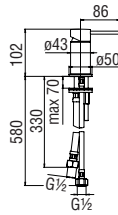

Cromo lucido	WE00110/9VECR		166,00 €
Inox spazzolato	WE00110/9VEIX		249,00 €
Grafite spazzolato PVD	WE00110/9VEGUP		265,00 €
Miele spazzolato PVD	WE00110/9VECGP	<b>NEW</b>	265,00 €
Caffè spazzolato	WE00110/9VESB	<b>NEW</b>	265,00 €
Tramonto lucido PVD	WE00110/9VERCP		265,00 €
Argilla spazzolato PVD	WE00110/9VERTP		265,00 €



CARTRIDGE  
WARRANTY



RCR350  
39,00 €

**Miscelatore monocomando**

- Limitatore di portata con freno al 50%
- Ingresso a 2 vie

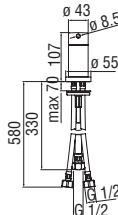

Cromo lucido	WE00110/9TCR		223,00 €
Inox spazzolato	WE00110/9TIX		333,00 €
Mora opaco	WE00110/9TBM		333,00 €
Neve opaco	WE00110/9TWM		333,00 €



CARTRIDGE  
WARRANTY



RCR350  
39,00 €

**Miscelatore monocomando**

- Limitatore di portata con freno al 50%
- Ingresso a 2 vie

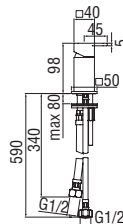

Cromo lucido	LP90110/9CR		360,00 €
--------------	-------------	--	----------



CARTRIDGE  
WARRANTY



RCR350  
39,00 €

**Miscelatore monocomando**

- Limitatore di portata con freno al 50%
- Ingresso a 2 vie

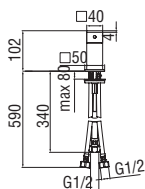

Cromo lucido	WE00110/9QCR	345,00 €
Inox spazzolato	WE00110/9QIX	517,00 €
Mora opaco	WE00110/9QBM	517,00 €



CARTRIDGE  
WARRANTY



RCR350  
39,00 €

**Piantane**

- Ingresso a 2 vie

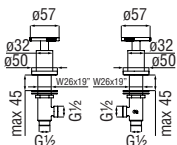

Inox spazzolato	SO130204IX	<b>NEW</b>	398,00 €
Grafite spazzolato PVD	SO130204GUP	<b>NEW</b>	424,00 €
Caffè spazzolato	SO130204SB	<b>NEW</b>	424,00 €
Argilla spazzolato PVD	SO130204RTP	<b>NEW</b>	424,00 €
Cromo lucido	SO130204CR	<b>NEW</b>	265,00 €



RVT200/5D  
18,00 €



RVT200/5S  
18,00 €

**Piantane**

- Ingresso a 2 vie

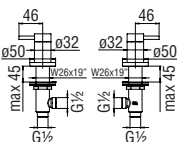

Cromo lucido	VE125204CR	168,00 €
Inox spazzolato	VE125204IX	252,00 €
Grafite spazzolato PVD	VE125204GUP	269,00 €
Miele spazzolato PVD	VE125204CGP	<b>NEW</b> 269,00 €
Caffè spazzolato	VE125204SB	<b>NEW</b> 269,00 €
Tramonto lucido PVD	VE125204RCP	269,00 €
Argilla spazzolato PVD	VE125204RTP	269,00 €



RVT200/5D  
18,00 €



RVT200/5S  
18,00 €

**Piantane**

- Ingresso a 2 vie

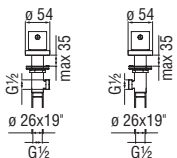

Cromo lucido	WE00204/TCR	144,00 €
Inox spazzolato	WE00204/TIX	216,00 €
Mora opaco	WE00204/TBM	216,00 €
Neve opaco	WE00204/TWM	216,00 €



RVT200/5D  
18,00 €

**Piantane**

· Ingresso a 2 vie

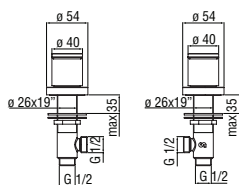

Cromo lucido	UP94204CR	144,00 €
Mora opaco	UP94204BM	216,00 €

 RVT200/5S  
18,00 €

 RVT200/5D  
18,00 €

**Piantane**

· Ingresso a 2 vie

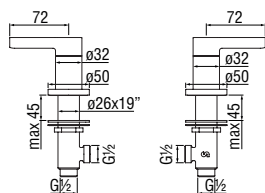

Cromo lucido	LR116204/TICR	250,00 €
Mora opaco	LR116204/TIBM	375,00 €

 RVT200/5D  
18,00 €

 RVT200/5S  
18,00 €

**Piantane**

· Ingresso a 2 vie

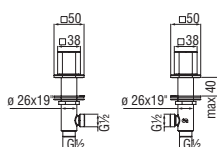

Cromo lucido	LP90204CR	200,00 €
--------------	-----------	----------

 RVT200/5D  
18,00 €

**Piantane**

· Ingresso a 2 vie

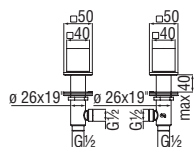

Cromo lucido	WE00204/QCR	188,00 €
Inox spazzolato	WE00204/QIX	282,00 €
Mora opaco	WE00204/QBM	282,00 €

 RVT200/5D  
18,00 €

**Piantane**

· Ingresso a 2 vie

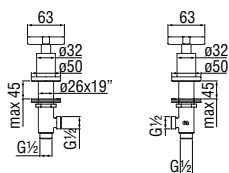

Cromo lucido	LR116204CR		250,00 €
Grafite spazzolato PVD	LR116204GUP	<b>NEW</b>	400,00 €
Mora opaco	LR116204BM		375,00 €

**Piantane**

· Ingresso a 2 vie

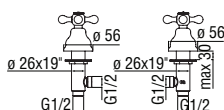

Cromo lucido	GR05204CR		168,00 €
Miele spazzolato PVD	GR05204CGP	<b>NEW</b>	269,00 €



RVT200/5D  
18,00 €

BOCCHE

**Bocca bordo vasca**

· Aeratore anticalcare M 24 x 1

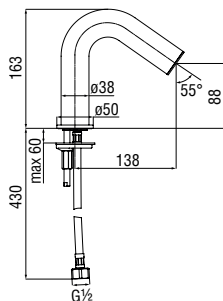

Inox spazzolato	AV00156/20IX	<b>NEW</b>	336,00 €
Grafite spazzolato PVD	AV00156/20GUP	<b>NEW</b>	358,00 €
Caffè spazzolato	AV00156/20SB	<b>NEW</b>	358,00 €
Argilla spazzolato PVD	AV00156/20RTP	<b>NEW</b>	358,00 €
Cromo lucido	AV00156/20CR	<b>NEW</b>	224,00 €



RAEK222/22  
45,00 € - 10 pz.

**Bocca bordo vasca**

· Aeratore anticalcare M 24 x 1

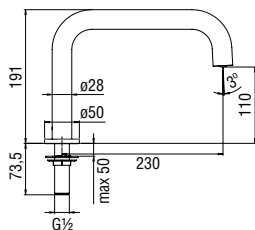

Cromo lucido	AV00156/19CR		142,00 €
Inox spazzolato	AV00156/19IX		212,00 €
Grafite spazzolato PVD	AV00156/19GUP		229,00 €
Miele spazzolato PVD	AV00156/19CGP	<b>NEW</b>	229,00 €
Caffè spazzolato	AV00156/19SB	<b>NEW</b>	229,00 €
Tramonto lucido PVD	AV00156/19RCP		229,00 €
Argilla spazzolato PVD	AV00156/19RTP		229,00 €



RAEK222/22  
45,00 € - 10 pz.

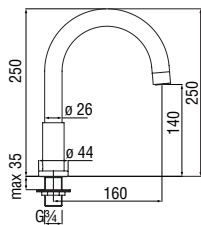

**Bocca bordo vasca**

· Aeratore anticalcare M 24 x 1

Cromo lucido	AV00156/15CR	141,00 €
Mora opaco	AV00156/15BM	212,00 €
Neve opaco	AV00156/15WM	212,00 €

RAEK219/43CR  
38,00 € - 5 pz.

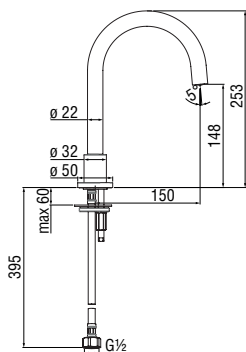

**Bocca bordo vasca**

· Aeratore anticalcare M 18,5 x 1

Cromo lucido	AV00156/16CR	154,00 €
Grafite spazzolato PVD	AV00156/16GUP	<b>NEW</b> 246,00 €
Mora opaco	AV00156/16BM	230,00 €

RAEK222/23  
43,00 € - 10 pz.

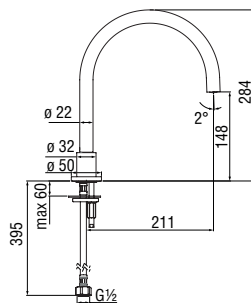

**Bocca bordo vasca**

· Aeratore anticalcare M 18,5 x 1

Cromo lucido	AV00156/17CR	205,00 €
Grafite spazzolato PVD	AV00156/17GUP	<b>NEW</b> 328,00 €
Mora opaco	AV00156/17BM	308,00 €

RAEK222/23  
43,00 € - 10 pz.

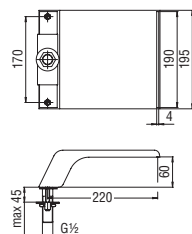

**Bocca bordo vasca**

· Getto cascata

Cromo lucido	AV00156CR	1.005,00 €
--------------	-----------	------------

**Bocca bordo vasca**

· Getto cascata

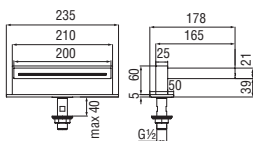

Cromo lucido	AV00156/8CR	969,00 €
Inox spazzolato	AV00156/8IX	1.454,00 €
Mora opaco	AV00156/8BM	1.454,00 €

**Bocca bordo vasca**

· Aeratore anticalcare M 28 x 1

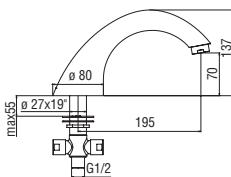

Cromo lucido	AV00158/2CR	373,00 €
Miele spazzolato PVD	AV00158/2CGP	<b>NEW</b> 597,00 €

 RAEK219/41CR  
47,00 € - 5 pz.

DEVIATORI

**Deviatore a 2 vie**

· Uscite ø 1/2"

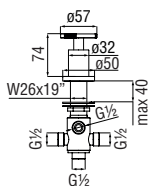

Inox spazzolato	SO130170IX	<b>NEW</b> 407,00 €
Grafite spazzolato PVD	SO130170GUP	<b>NEW</b> 434,00 €
Caffè spazzolato	SO130170SB	<b>NEW</b> 434,00 €
Argilla spazzolato PVD	SO130170RTP	<b>NEW</b> 434,00 €
Cromo lucido	SO130170CR	<b>NEW</b> 271,00 €

**Deviatore a 2 vie**

· Uscite ø 1/2"

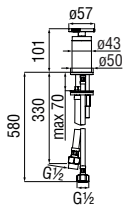

Inox spazzolato	WE00171/SOIX	<b>NEW</b> 398,00 €
Grafite spazzolato PVD	WE00171/SOGUP	<b>NEW</b> 424,00 €
Caffè spazzolato	WE00171/SOSB	<b>NEW</b> 424,00 €
Argilla spazzolato PVD	WE00171/SORTP	<b>NEW</b> 424,00 €
Cromo lucido	WE00171/SOCR	<b>NEW</b> 265,00 €

 20 YEARS  
CARTRIDGE  
WARRANTY

 RCR201/35FSC  
39,00 €

**Deviatore a 2 vie**

· Uscite ø 1/2"

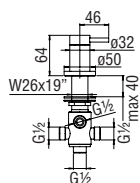

Cromo lucido	VE12517OCR	172,00 €
Inox spazzolato	VE12517OIX	258,00 €
Grafite spazzolato PVD	VE12517OGUP	275,00 €
Miele spazzolato PVD	VE12517OCGP	<b>NEW</b> 275,00 €
Caffè spazzolato	VE12517OSB	<b>NEW</b> 275,00 €
Tramonto lucido PVD	VE12517ORCP	275,00 €
Argilla spazzolato PVD	VE12517ORTP	275,00 €

**Deviatore a 2 vie**

· Uscite ø 1/2"

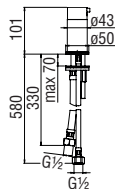

Cromo lucido	WE00171/TCR	168,00 €
Inox spazzolato	WE00171/TIX	252,00 €
Grafite spazzolato PVD	WE00171/TGUP	269,00 €
Miele spazzolato PVD	WE00171/TCGP	<b>NEW</b> 269,00 €
Caffè spazzolato	WE00171/TSB	<b>NEW</b> 269,00 €
Tramonto lucido PVD	WE00171/TRCP	269,00 €
Argilla spazzolato PVD	WE00171/TRTP	269,00 €



CARTRIDGE  
WARRANTY



RCR201/35FSC  
39,00 €

**Deviatore a 2 vie**

· Uscite ø 1/2"

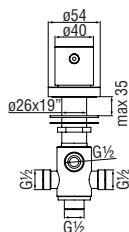

Cromo lucido	WE00170/TCR	244,00 €
Inox spazzolato	WE00170/TIX	365,00 €
Mora opaco	WE00170/TBM	365,00 €
Neve opaco	WE00170/TWM	365,00 €

**Deviatore 2 vie**

· Uscite ø 1/2"

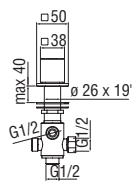

Cromo lucido	UP9417OCR	244,00 €
Mora opaco	UP9417OBM	365,00 €



**Deviatore a 2 vie**

· Uscite ø 1/2"

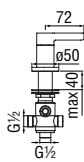

Cromo lucido	LR116170/T1CR	236,00 €
Mora opaco	LR116170/T1BM	353,00 €

**Deviatore 2 vie**

· Uscite ø 1/2"

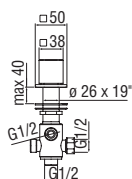

Cromo lucido	LP90170CR	268,00 €
--------------	-----------	----------

**Deviatore a 2 vie**

· Uscite ø 1/2"

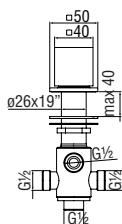

Cromo lucido	WE00170/QCR	267,00 €
Inox spazzolato	WE00170/QIX	400,00 €
Mora opaco	WE00170/QBM	400,00 €

**Deviatore a 2 vie**

· Uscite ø 1/2"

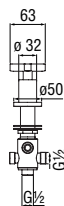

Cromo lucido	LR116170CR	236,00 €
Grafite spazzolato PVD	LR116170GUP	<b>NEW</b> 378,00 €
Mora opaco	LR116170BM	353,00 €

**Deviatore a 2 vie**

· Uscite ø 1/2"

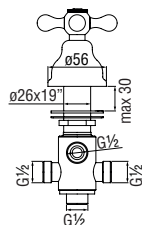

Cromo lucido	GR05170CR		260,00 €
Miele spazzolato PVD	GR05170CGP	<b>NEW</b>	416,00 €

SET DOCCIA

**Set doccia**

· Doccetta monogetto estraibile

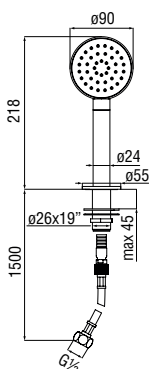

Inox spazzolato	NR00238/28IX	<b>NEW</b>	251,00 €
Grafite spazzolato PVD	NR00238/28GUP	<b>NEW</b>	267,00 €
Caffè spazzolato	NR00238/28SB	<b>NEW</b>	267,00 €
Argilla spazzolato PVD	NR00238/28RTP	<b>NEW</b>	267,00 €
Cromo lucido	NR00238/28CR	<b>NEW</b>	167,00 €

**Set doccia**

· Doccetta monogetto estraibile

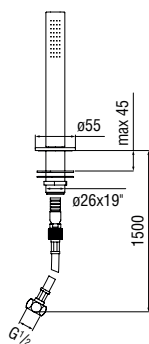

Cromo lucido	NR00238/22CR		106,00 €
Inox spazzolato	NR00238/22IX		151,00 €
Grafite spazzolato PVD	NR00238/22GUP		170,00 €
Mora opaco	NR00238/22BM		151,00 €
Neve opaco	NR00238/22WM		151,00 €
Miele spazzolato PVD	NR00238/22CGP	<b>NEW</b>	170,00 €
Caffè spazzolato	NR00238/22SB	<b>NEW</b>	170,00 €
Tramonto lucido PVD	NR00238/22RCP		170,00 €
Argilla spazzolato PVD	NR00238/22RTP		170,00 €

**Set doccia**

· Doccetta a 3 getti estraibile

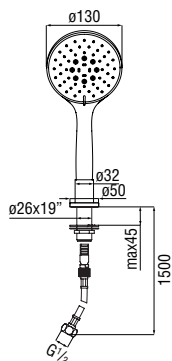

Cromo lucido	NR00238/26CR	<b>MOD</b>	116,00 €
Grafite spazzolato PVD	NR00238/26GUP	<b>NEW</b>	186,00 €
Mora opaco	NR00238/26BM	<b>MOD</b>	164,00 €

SET DOCCIA

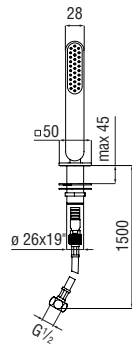

**Set doccia**

· Doccetta monogetto estraibile

Cromo lucido NR00238/20CR **MOD** 149,00 €

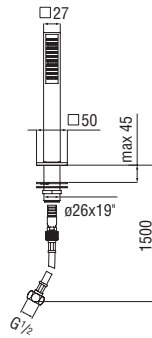

**Set doccia**

· Doccetta monogetto estraibile

Cromo lucido NR00238/21CR 137,00 €

Inox spazzolato NR00238/21IX 195,00 €

Mora opaco NR00238/21BM 195,00 €

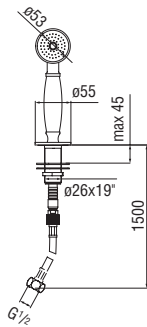

**Set doccia**

· Doccetta monogetto estraibile

Cromo lucido NR00238/19CR 109,00 €

Miele spazzolato PVD NR00238/19CGP **NEW** 174,00 €

ACCESSORI

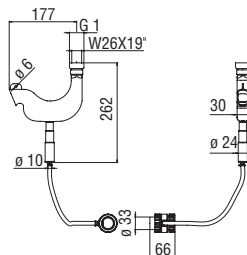

**Sistema di raccolta acqua**

· Adattatore universale

- AV00047 141,00 €



ARTICOLI VARI

# CANALINE DOCCIA

Centro Stile Nobili

Soluzione innovativa per l'ambiente doccia, le canaline di scarico assecondano le esigenze del bagno moderno: due varianti di sifone (85 e 105 mm), sei stili (cinque griglie dal diverso design più una piastrellabile), cinque misure disponibili (70, 80, 90, 100, 120 cm) oltre alla possibilità di realizzare un'installazione modulare creando una linea continua di singole unità.



Cromo lucido

PARTE INCASSO

Parte incasso necessaria

· Sifone 105 mm

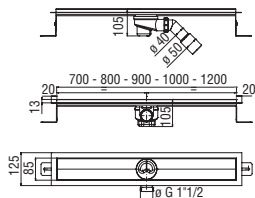

70 cm	AVCDA/07	507,00 €
80 cm	AVCDA/08	546,00 €
90 cm	AVCDA/09	580,00 €
100 cm	AVCDA/10	618,00 €
120 cm	AVCDA/12	689,00 €

Parte incasso necessaria

· Sifone 85 mm

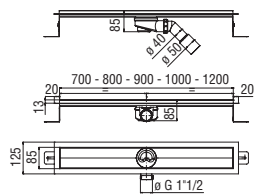

70 cm	AVCDB/07	507,00 €
80 cm	AVCDB/08	546,00 €
90 cm	AVCDB/09	580,00 €
100 cm	AVCDB/10	618,00 €
120 cm	AVCDB/12	689,00 €

PARTE ESTERNA LINEA

Parte esterna

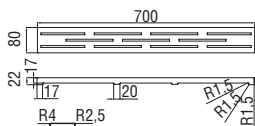

70 cm	AVGR01/07CR	181,00 €
80 cm	AVGR01/08CR	191,00 €
90 cm	AVGR01/09CR	205,00 €
100 cm	AVGR01/10CR	215,00 €
120 cm	AVGR01/12CR	240,00 €

PARTE ESTERNA GRAFFITI

Parte esterna

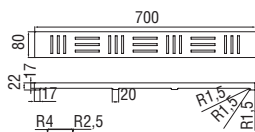

70 cm	AVGR02/07CR	181,00 €
80 cm	AVGR02/08CR	191,00 €
90 cm	AVGR02/09CR	205,00 €
100 cm	AVGR02/10CR	215,00 €
120 cm	AVGR02/12CR	240,00 €

PARTE ESTERNA TESSERA

Parte esterna

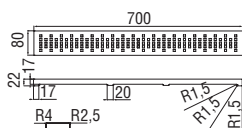

70 cm	AVGR03/07CR	181,00 €
80 cm	AVGR03/08CR	191,00 €
90 cm	AVGR03/09CR	205,00 €
100 cm	AVGR03/10CR	215,00 €
120 cm	AVGR03/12CR	240,00 €

PARTE ESTERNA FUSION

Parte esterna

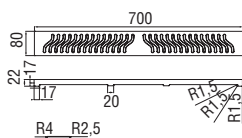

70 cm	AVGR04/07CR	181,00 €
80 cm	AVGR04/08CR	191,00 €
90 cm	AVGR04/09CR	205,00 €
100 cm	AVGR04/10CR	215,00 €
120 cm	AVGR04/12CR	240,00 €

PARTE ESTERNA TILE

Parte esterna

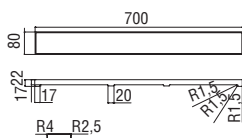

70 cm	AVGR05/07CR	181,00 €
80 cm	AVGR05/08CR	191,00 €
90 cm	AVGR05/09CR	205,00 €
100 cm	AVGR05/10CR	215,00 €
120 cm	AVGR05/12CR	240,00 €

PARTE ESTERNA MINIMAL

Parte esterna

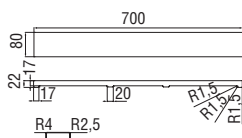

70 cm	AVGR06/07CR	181,00 €
80 cm	AVGR06/08CR	191,00 €
90 cm	AVGR06/09CR	205,00 €
100 cm	AVGR06/10CR	215,00 €
120 cm	AVGR06/12CR	240,00 €

**Kit di fissaggio**

· Per parte incasso

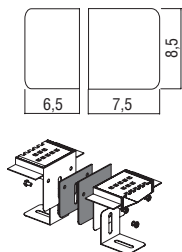

- AVCDR01 41,00 €

**Guaina di isolamento preformata**

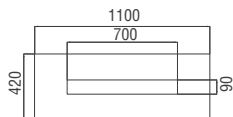
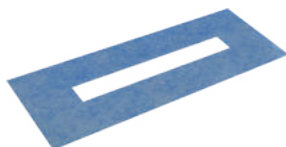

110 x 42 cm	AVGUA/07	27,00 €
123 x 42 cm	AVGUA/08	30,00 €
141 x 42 cm	AVGUA/09	42,00 €
141 x 42 cm	AVGUA/10	42,00 €
164 x 42 cm	AVGUA/12	45,00 €

**Guaina di isolamento in polietilene**

· Larghezza rotolo 100 cm

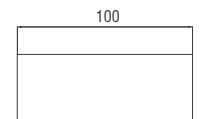

Rotolo 10 m	AVGUA/100	332,00 €
Rotolo 30 m	AVGUA/300	956,00 €

**Guaina di isolamento in polietilene**

· Doppio strato di tessuto - non tessuto  
· Larghezza rotolo 12 cm

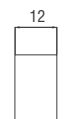

Rotolo 10 m	AVROG/100	6,00 €
-------------	-----------	--------

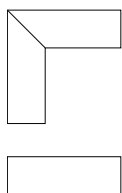
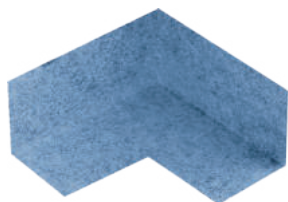

**Angolo chiuso preformato**

- AVANG/I 24,00 €

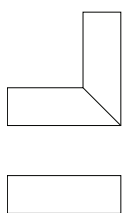
**Angolo aperto preformato**

- AVANG/E 24,00 €

**Nastro butilico bi-adesivo**

· Per fissaggio guaina su canalina doccia

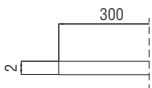

- AVNAS/3 17,00 €



ARTICOLI VARI

# SALA MOSTRA

Centro Stile Nobili

La sezione Sala mostra raccoglie gli articoli dedicati alla presentazione del nostro prodotto: espositori da terra o da parete (compatibili con basetta amovibile dotata di infografica interattiva, in grado di visualizzare la scheda tecnica del modello esposto) e da tavolo, tra cui l'espositore ideato per presentare le caratteristiche del miscelatore Sorgente Filtra.



**Espositore da terra per prodotti su bassetta**

- Per 3 miscelatori
- Basetta amovibile
- Supporto per montaggio modulare
- Area documentazione
- Rubinetteria non inclusa
- Documentazione non inclusa

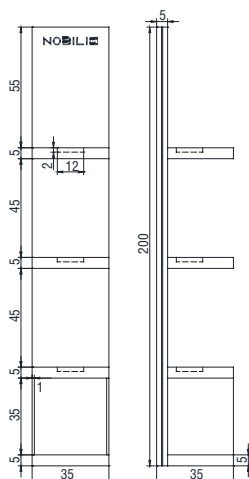

- ESP233/11NOB 675,00 €

**Espositore da terra per prodotti a parete**

- Supporto per montaggio modulare
- Rubinetteria non inclusa

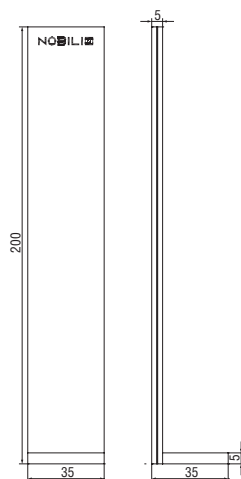

- ESP233/12NOB 546,00 €

**Espositore da parete per prodotti su basetta**

- Per 3 miscelatori
- Basetta amovibile
- Rubinetteria non inclusa

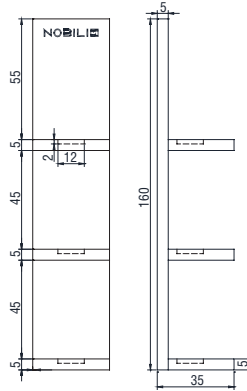

- ESP233/31NOB 638,00 €

**Espositore da parete per prodotti a parete**

- Rubinetteria non inclusa



- ESP233/32NOB 505,00 €

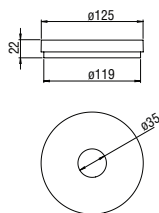

**Basetta per espositore**

- Completa di codice miscelatore e QR Code
- Rubinetteria non inclusa

- ESP233/17 36,00 €

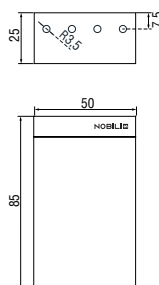

**Espositore da terra**

- Per 4 miscelatori
- Rubinetteria non inclusa

- ESP233/19 393,00 €

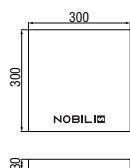

**Espositore da terra per colonna a pavimento**

- Rubinetteria non inclusa

- ESP233/33NOB 147,00 €

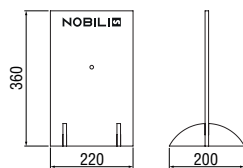

**Espositore da tavolo per doccia wc**

- Kit, flessibile e piastra di fissaggio inclusi
- Rubinetteria non inclusa

- KVR0E600 108,00 €

**Espositore da tavolo per Easybox 2 vie**

· Rubinetteria inclusa

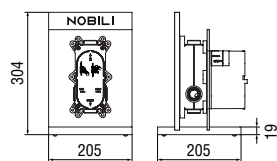

- \_\_\_\_\_ ESP233/94S 285,00 €

**Espositore da tavolo per Wellbox 2 vie**

· Rubinetteria inclusa

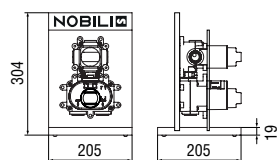

- \_\_\_\_\_ ESP233/92S 365,00 €

**Espositore da terra**

· Per 5 miscelatori  
· Rubinetteria non inclusa

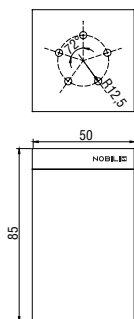

- \_\_\_\_\_ ESP233/14 558,00 €

**Espositore da tavolo**

· Per 5 miscelatori  
· Rubinetteria non inclusa

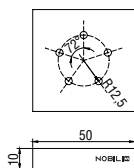

- \_\_\_\_\_ ESP233/14C 293,00 €

**Espositore da tavolo per Sorgente Filtra**

· Rubinetteria non inclusa

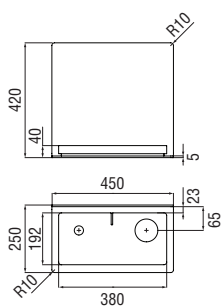

- ESP233/40 **NEW** 240,00 €

BOX

**The Premium Box**

· Completo di documentazione collezioni Premium

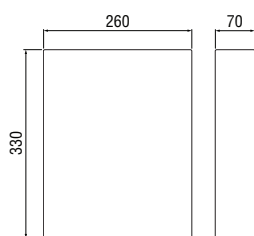
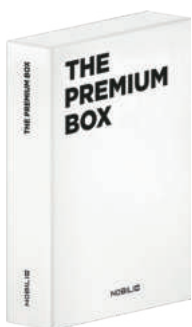

- ACATABOX/PREMIUM 220,00 €

**Wonders of Colors**

· Completo di 10 campioni finiture in ottone

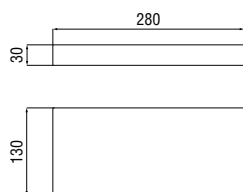

- AESPOFINISH **MOD** 345,00 €

**Choose your Dress**

· Completo di 16 leve in ottone cromato con i vari rivestimenti

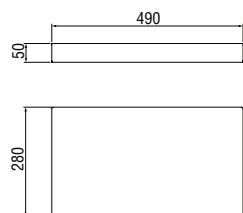

- AESPO106001 1.178,00 €



## PARTI DI RICAMBIO

Le parti di ricambio più ricercate: aeratori, vitoni, componenti vari e le cartucce più utilizzate all'interno dei nostri miscelatori: realizzate all'interno dei nostri reparti con materiali di prim'ordine e metodologie di produzione automatizzate, garantiscono un movimento morbido e fluido della leva per lungo tempo.





#### **CARTUCCE E VITONI**

CARTUCCE	537
VITONI	540

#### **AERATORI**

NEOPERL® CASCADE® SLC®	543
NEOPERL® CASCADE®	544
AMFAG INVISIO JUNIOR	545
NEOPERL® CACHÉ®	545
NEOPERL® CACHÉ® COIN SLOT	545
NEOPERL® PERLATOR®	546

PARTI DI RICAMBIO

# CARTUCCE E VITONI

Centro Stile Nobili

Le cartucce e i vitoni più utilizzati all'interno dei nostri miscelatori, presentate con immagine e descrizione delle caratteristiche più salienti. Progettate e realizzate all'interno del Nobili Technology Centre con materiali di prim'ordine e metodologie di produzione totalmente automatizzate, garantiscono per lungo tempo un movimento morbido e fluido della leva.



**Cartuccia Nobili Widd® 2020**

- Diametro ø 34 mm
- Astina in ottone
- Piastrine in ceramica
- Movimento senza deposito di calcare
- Materiale plastico in Ultem™ 2200

RCR2020

41,00 €

**Cartuccia Nobili Widd®**

- Diametro ø 28 mm
- Astina in ottone
- Limitatore di temperatura
- Piastrine in ceramica
- Movimento senza deposito di calcare
- Materiale plastico in Ultem™ 2200
- Garanzia 20 anni

RCR280/D

39,00 €

**Cartuccia Nobili Widd® ECO**

- Diametro ø 28 mm
- Apertura in acqua fredda
- Astina in ottone
- Limitatore di temperatura
- Piastrine in ceramica
- Movimento senza deposito di calcare
- Materiale plastico in Ultem™ 2200
- Garanzia 20 anni

RCR280/DECO

50,00 €

**Cartuccia Nobili Widd®**

- Diametro ø 28 mm
- Portata 4 l/min
- Astina in ottone
- Limitatore di temperatura
- Piastrine in ceramica
- Movimento senza deposito di calcare
- Materiale plastico in Ultem™ 2200
- Garanzia 20 anni

RCR284/D

39,00 €

**Cartuccia Nobili Widd®**

- Diametro ø 35 mm
- Astina in ottone
- Limitatore di temperatura
- Piastrine in ceramica
- Movimento senza deposito di calcare
- Materiale plastico in Ultem™ 2200
- Garanzia 20 anni

RCR340

39,00 €

**Cartuccia Nobili Widd®**

- Diametro ø 35 mm
- Astina in ottone
- Limitatore di temperatura
- Piastrine in ceramica
- Movimento senza deposito di calcare
- Materiale plastico in Ultem™ 2200
- Garanzia 20 anni

RCR350

39,00 €

**Cartuccia Nobili Widd®**

- Diametro ø 35 mm
- Astina in ottone
- Limitatore di temperatura
- Piastrine in ceramica
- Movimento senza deposito di calcare
- Materiale plastico in Ultem™ 2200
- Garanzia 20 anni

RCR350/D

39,00 €

**Cartuccia Nobili Widd®**

- Per miscelatore leva clinica
- Diametro ø 35 mm
- Astina in ottone
- Limitatore di temperatura
- Piastrine in ceramica
- Movimento senza deposito di calcare
- Materiale plastico in Ultem™ 2200
- Garanzia 20 anni

RCR350/DCL

39,00 €

**Cartuccia Nobili Widd® ECO**

- Diametro ø 35 mm
- Apertura in acqua fredda
- Astina in ottone
- Limitatore di temperatura
- Piastrine in ceramica
- Movimento senza deposito di calcare
- Materiale plastico in Ultem™ 2200
- Garanzia 20 anni

RCR350/ECO

48,00 €

**Cartuccia Nobili Widd®**

- Diametro ø 35 mm
- Astina in ottone
- Limitatore di temperatura
- Piastrine in ceramica
- Movimento senza deposito di calcare
- Materiale plastico in Ultem™ 2200
- Garanzia 20 anni

RCR360/D

39,00 €

**Cartuccia Nobili Widd®**

- Per miscelatore leva clinica
- Diametro ø 35 mm
- Astina in ottone
- Limitatore di temperatura
- Piastrine in ceramica
- Movimento senza deposito di calcare
- Materiale plastico in Ultem™ 2200
- Garanzia 20 anni

RCR360/DCL 39,00 €

**Cartuccia Nobili Widd®**

- 90° sinistro
- Astina in ottone
- Piastrine in ceramica
- Movimento senza deposito di calcare
- Materiale plastico in Ultem™ 2200

RCR200/33S 39,00 €

**Cartuccia Nobili Widd®**

- 90° destro
- Astina in ottone
- Piastrine in ceramica
- Movimento senza deposito di calcare
- Materiale plastico in Ultem™ 2200

RCR200/37 39,00 €

**Cartuccia Nobili**

- Diametro ø 40 mm
- Astina in ottone
- Piastrine in ceramica

RCR440 39,00 €

**Cartuccia Nobili Joystick**

- Diametro ø 40 mm
- Astina in ottone
- Piastrine in ceramica

RCR450 39,00 €

**Cartuccia Nobili Joystick**

- Diametro ø 40 mm
- Astina in ottone
- Piastrine in ceramica

RCR465 41,00 €

**Cartuccia**

- Diametro ø 25 mm
- Astina in ottone
- Piastrine in ceramica

RCR107040 18,00 €

**Cartuccia a pulsante temporizzato**

- Indicazione in colore blu

RCR35000/B 44,00 €

**Cartuccia a pulsante temporizzato**

- Indicazione in colore verde

RCR35000/V 44,00 €

**Cartuccia deviatrice Nobili Widd®**

- Diametro ø 28 mm
- Astina in ottone
- Piastrine in ceramica
- Movimento senza deposito di calcare
- Materiale plastico in Ultem™ 2200

RCR201/28 39,00 €

**Cartuccia deviatrice Nobili Widd®**

- Diametro ø 35 mm
- Astina in ottone
- Piastrine in ceramica
- Movimento senza deposito di calcare
- Materiale plastico in Ultem™ 2200

RCR201/35FSC 39,00 €

**Cartuccia deviatrice Nobili Widd®**

- Diametro ø 35 mm
- Astina in ottone
- Piastrine in ceramica
- Movimento senza deposito di calcare
- Materiale plastico in Ultem™ 2200

RCR201/3SC 39,00 €

**Cartuccia deviatrice Nobili Widd®**

- Diametro ø 35 mm
- Astina in ottone
- Piastrine in ceramica
- Movimento senza deposito di calcare
- Materiale plastico in Ultem™ 2200

RCR201/70 39,00 €

**Cartuccia deviatrice Nobili Widd®**

- Diametro ø 35 mm
- Astina in ottone
- Piastrine in ceramica
- Movimento senza deposito di calcare
- Materiale plastico in Ultem™ 2200

RCR201/70SC 39,00 €

**Cartuccia deviatrice**

- Piastrine in ceramica

RCR201/45 21,00 €

**Cartuccia deviatrice**

- Astina in ottone
- Piastrine in ceramica

RCR201/59 51,00 €

**Cartuccia deviatrice**

- Astina in ottone
- Piastrine in ceramica

RCR201/57 51,00 €

**Cartuccia Nobili Thermotech®**

- Blocco di sicurezza 38° C
- Astina in ottone
- Dotata di filtri
- Materiale plastico in Ultem™ 2200

RCR201/5 58,00 €

**Cartuccia Nobili Thermotech®**

- Blocco di sicurezza 38° C
- Astina in ottone
- Dotata di filtri
- Materiale plastico in Ultem™ 2200

RCR201/6 58,00 €

**Cartuccia Nobili Thermotech®**

- Blocco di sicurezza 38° C
- Astina in ottone
- Materiale plastico in Ultem™ 2200

RCR201/56 58,00 €

**Cartuccia Nobli Thermotech®**

- Per miscelatore corpo freddo
- Blocco di sicurezza 38° C
- Astina in ottone
- Materiale plastico in Ultem™ 2200

RCR201/56A

58,00 €

**Cartuccia termostatica**

- Per miscelatore incasso a pulsante
- Astina in ottone

RCR201/40

132,00 €

**Vitone a dischi ceramici**

- ø 1/2"
- 180°
- Astina in ottone
- Piastrine in ceramica
- Asta frizionata

RVT200/10

18,00 €

**Vitone a dischi ceramici**

- ø 1/2"
- 180°
- Astina in ottone
- Piastrine in ceramica
- Asta frizionata

RVT200/26

18,00 €

**Vitone a dischi ceramici**

- ø 1/2"
- 180°
- Astina in ottone
- Piastrine in ceramica
- Asta frizionata

RVT200/28

21,00 €

**Vitone a dischi ceramici**

- 90°
- Astina in ottone
- Piastrine in ceramica
- Asta frizionata

RVT200/73

20,00 €

**Vitone a dischi ceramici**

- ø 1/2"
- 90° sinistro
- Astina in ottone
- Piastrine in ceramica
- Asta frizionata

RVT200/5S

18,00 €

**Vitone a dischi ceramici**

- ø 1/2"
- 90° destro
- Astina in ottone
- Piastrine in ceramica
- Asta frizionata

RVT200/5D

18,00 €

**Vitone**

- Per miscelatore incasso passo rapido
- ø 3/4"
- Astina in ottone

RVT200/30

30,00 €

**Vitone temporizzato**

RVT200/31

74,00 €

---

**Vitone a pulsante**

· Per miscelatore incasso a pulsante



RVT200/40

139,00 €

---



PARTI DI RICAMBIO

# AERATORI

Centro Stile Nobili

Gli aeratori in dotazione ai nostri miscelatori, corredati da immagine e descrizione delle caratteristiche più importanti, come la possibilità di pulirlo con un semplice passaggio del dito, oppure la portata ridotta a 5 litri al minuto, in grado di mantenere un flusso aerato e garantire allo stesso tempo un notevole risparmio idrico, riducendo le spese di gestione e contribuendo a salvaguardare l'ambiente.



**Aeratore Neoperl® Cascade® SLC®**

- M 22 x 1
- Portata 5 l/min
- Protezione anticalcare
- Superficie morbida in elastomero
- Rimozione calcare tramite passaggio dito
- Confezione da 10 pezzi

RAEK219/67CR 75,00 €

**Aeratore Neoperl® Cascade® SLC®**

- M 22 x 1
- Protezione anticalcare
- Superficie morbida in elastomero
- Rimozione calcare tramite passaggio dito
- Confezione da 10 pezzi

RAEK219/63CR 53,00 €

**Aeratore Neoperl® Cascade® SLC®**

- M 22 x 1
- Protezione anticalcare
- Superficie morbida in elastomero
- Rimozione calcare tramite passaggio dito
- Confezione da 10 pezzi

RAEK220/36CR 53,00 €

**Aeratore Neoperl® Cascade® SLC®**

- M 22 x 1
- Protezione anticalcare
- Superficie morbida in elastomero
- Rimozione calcare tramite passaggio dito

RAE220/40CR 22,00 €

**Aeratore Neoperl® Cascade® SLC®**

- M 22 x 1
- Protezione anticalcare
- Superficie morbida in elastomero
- Rimozione calcare tramite passaggio dito

RAE219/47CR 23,00 €

**Aeratore Neoperl® Cascade® SLC®**

- M 24 x 1
- Protezione anticalcare
- Superficie morbida in elastomero
- Rimozione calcare tramite passaggio dito
- Confezione da 5 pezzi

RAEK219/43CR 38,00 €

**Aeratore Neoperl® Cascade® SLC®**

- M 24 x 1
- Protezione anticalcare
- Superficie morbida in elastomero
- Rimozione calcare tramite passaggio dito
- Confezione da 10 pezzi

RAEK220/66CR 47,00 €

**Aeratore Neoperl® Cascade® SLC®**

- M 24 x 1
- Protezione anticalcare
- Superficie morbida in elastomero
- Rimozione calcare tramite passaggio dito
- Confezione da 10 pezzi

RAEK220/35CR 29,00 €

**Aeratore Neoperl® Cascade® SLC®**

- M 24 x 1
- Protezione anticalcare
- Superficie morbida in elastomero
- Rimozione calcare tramite passaggio dito
- Confezione da 10 pezzi

RAEK220/37CR 47,00 €

**Aeratore Neoperl® Cascade® SLC®**

- M 28 x 1
- Protezione anticalcare
- Superficie morbida in elastomero
- Rimozione calcare tramite passaggio dito
- Confezione da 5 pezzi

RAEK219/41CR 47,00 €

**Aeratore Neoperl® Cascade® SLC®**

- M 22 x 1
- Protezione anticalcare
- Superficie morbida in elastomero
- Rimozione calcare tramite passaggio dito
- Dotato di snodo

RAE219/64CR 23,00 €

**Aeratore Neoperl® Cascade® SLC®**

- M 24 x 1
- Protezione anticalcare
- Superficie morbida in elastomero
- Rimozione calcare tramite passaggio dito
- Dotato di snodo

RAE219/61CR 23,00 €

**Aeratore Neoperl® Cascade® SLC®**

- M 24 x 1
- Protezione anticalcare
- Superficie morbida in elastomero
- Rimozione calcare tramite passaggio dito
- Dotato di snodo

RAE220/37CR 21,00 €

**Aeratore Neoperl® Cascade®**

- M 22 x 1
- Protezione anticalcare
- Confezione da 10 pezzi

RAEK221/4CR 45,00 €

**Aeratore Neoperl® Cascade®**

- M 24 x 1
- Portata 5 l/min
- Protezione anticalcare
- Confezione da 10 pezzi

RAEK219/14CR 58,00 €

**Aeratore Neoperl® Cascade®**

- M 24 x 1
- Protezione anticalcare
- Confezione da 10 pezzi

RAEK220/14CR 45,00 €

**Aeratore Neoperl® Cascade®**

- M 24 x 1
- Portata 5 l/min
- Protezione anticalcare
- Confezione da 10 pezzi

RAEK219/23CR 61,00 €

**Aeratore Neoperl® Cascade®**

- M 24 x 1
- Protezione anticalcare
- Confezione da 10 pezzi

RAEK220/32CR 45,00 €

**Aeratore Neoperl® Cascade®**

- M 24 x 1
- Protezione anticalcare
- Confezione da 5 pezzi

RAEK219/44CR 27,00 €

**Aeratore Neoperl® Cascade®**

- M 28 x 1
- Protezione anticalcare
- Confezione da 5 pezzi

RAEK219/4CR 43,00 €

**Aeratore Neoperl® Cascade®**

- M 24 x 1
- Portata 5 l/min
- Protezione anticalcare
- Dotato di snodo

RAEK219/22CR 22,00 €

**Aeratore Amfag Invisio Junior**

- M 18 x 1
- Portata 5 l/min
- Protezione anticalcare
- Confezione da 10 pezzi

RAEK222/42 45,00 €

**Aeratore Neoperl® Caché®**

- M 24 x 1
- Portata 8 l/min
- Protezione anticalcare
- Confezione da 10 pezzi

RAEK222/45 63,00 €

**Aeratore Neoperl® Caché® Coin Slot**

- M 16,5 x 1
- Portata 5 l/min
- Protezione anticalcare
- Avvitamento tramite moneta
- Confezione da 10 pezzi

RAEK219/28 58,00 €

**Aeratore Neoperl® Caché® Coin Slot**

- M 16,5 x 1
- Portata 8 l/min
- Protezione anticalcare
- Avvitamento tramite moneta
- Confezione da 10 pezzi

RAEK219/280 61,00 €

**Aeratore Neoperl® Caché® Coin Slot**

- M 16,5 x 1
- Protezione anticalcare
- Avvitamento tramite moneta
- Confezione da 10 pezzi

RAEK222/20 58,00 €

**Aeratore Neoperl® Caché® Coin Slot**

- M 18,5 x 1
- Portata 5 l/min
- Protezione anticalcare
- Avvitamento tramite moneta
- Confezione da 10 pezzi

RAEK222/44 61,00 €

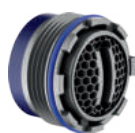
**Aeratore Neoperl® Caché® Coin Slot**

- M 18,5 x 1
- Protezione anticalcare
- Avvitamento tramite moneta
- Confezione da 10 pezzi

RAEK222/23 43,00 €

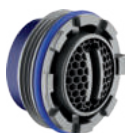
**Aeratore Neoperl® Caché® Coin Slot**

- M 21,5 x 1
- Protezione anticalcare
- Avvitamento tramite moneta
- Confezione da 10 pezzi

RAEK222/26 45,00 €

**Aeratore Neoperl® Caché® Coin Slot**

- M 24 x 1
- Protezione anticalcare
- Avvitamento tramite moneta
- Confezione da 10 pezzi

RAEK222/22 45,00 €

**Aeratore Neoperl® Caché® Coin Slot**

- M 24 x 1
- Protezione anticalcare
- Avvitamento tramite moneta
- Confezione da 10 pezzi

RAEK222/27 45,00 €

**Aeratore Neoperl® Caché® Coin Slot**

- M 16 x 1
- Portata 5 l/min
- Protezione anticalcare
- Avvitamento tramite moneta
- Dotato di snodo

RAE219/28CR 22,00 €

**Aeratore Neoperl® Caché® Coin Slot**

- M 16 x 1
- Portata 8 l/min
- Protezione anticalcare
- Avvitamento tramite moneta
- Dotato di snodo

RAE219/280CR 27,00 €

**Aeratore Neoperl® Caché® Coin Slot**

- M 16 x 1
- Protezione anticalcare
- Avvitamento tramite moneta
- Dotato di snodo

RAE222/25CR 21,00 €

**Aeratore Neoperl® Caché® Coin Slot**

- M 16,5 x 1
- Portata 5 l/min
- Protezione anticalcare
- Avvitamento tramite moneta
- Dotato di snodo

RAE220/51CR 21,00 €

**Aeratore Neoperl® Caché® Coin Slot**

- M 18,5 x 1
- Protezione anticalcare
- Avvitamento tramite moneta
- Dotato di snodo

RAE222/24CR 17,00 €

**Aeratore Neoperl® Perlator®**

- M 16 x 1
- Portata 5 l/min
- Protezione anticalcare
- Confezione da 10 pezzi

RAEK222/12CR 69,00 €

**Aeratore Neoperl® Perlator®**

- M 16 x 1
- Portata 8 l/min
- Protezione anticalcare
- Confezione da 10 pezzi

RAEK222/10CR 58,00 €

**Aeratore Neoperl® Perlator®**

- M 18 x 1
- Protezione anticalcare
- Confezione da 10 pezzi

RAEK220/27CR 43,00 €

**Aeratore Neoperl® Perlator®**

- M 22 x 1
- Dual Flow
- Protezione anticalcare
- Confezione da 10 pezzi

RAEK219/38CR 100,00 €



**Aeratore Neoperl® Perlator®**

- M 24 x 1
- Portata 8 l/min
- Protezione anticalcare
- Confezione da 10 pezzi

RAEK219/73CR

65,00 €



**Aeratore Neoperl® Perlator®**

- M 16 x 1
- Portata 5 l/min
- Protezione anticalcare
- Dotato di snodo

RAE222/43CR

29,00 €



**Aeratore Neoperl® Perlator®**

- Rettangolare 28 x 7
- Protezione anticalcare
- Dotato di chiave di montaggio
- Confezione da 5 pezzi

RAEK222/28

93,00 €



**Aeratore Neoperl® Perlator®**

- Rettangolare 40 x 10
- Protezione anticalcare
- Dotato di chiave di montaggio
- Confezione da 5 pezzi

RAEK219/27

96,00 €

# INDICE ALFABETICO

L'indice alfabetico generale, ordinato secondo la codifica dell'articolo, si propone come il metodo più semplice e veloce attraverso il quale è possibile risalire immediatamente alle informazioni essenziali riguardanti il prodotto d'interesse, quali la collezione d'appartenenza, il prezzo e la pagina dove trovare ulteriori dettagli tecnici e commerciali.

CODICE	COLLEZIONE	EURO	PAG.	CODICE	COLLEZIONE	EURO	PAG.
AB87010/1BM	ABC	416,00	236	AB87199BM	ABC	293,00	232
AB87010/1BM	TERMOSTATICI ESTERNI	416,00	382	AB87199BM	ALLBOX	293,00	296
AB87010/1CR	ABC	308,00	236	AB87199CR	ABC	217,00	232
AB87010/1CR	TERMOSTATICI ESTERNI	308,00	382	AB87199CR	ALLBOX	217,00	296
AB87010BM	ABC	450,00	236	AB87211/1BM	ABC	331,00	231
AB87010BM	TERMOSTATICI ESTERNI	450,00	385	AB87211/1CR	ABC	245,00	231
AB87010CR	ABC	333,00	236	AB87338/2BM	ABC	398,00	231
AB87010CR	TERMOSTATICI ESTERNI	333,00	385	AB87338/2CR	ABC	295,00	231
AB87030BM	ABC	300,00	236	AB87713CR	CUCINA ENNE	244,00	471
AB87030BM	TERMOSTATICI ESTERNI	300,00	380	ABH87118/1BM	ABC	130,00	229
AB87030CR	ABC	222,00	236	ABH87118/1CR	ABC	96,00	229
AB87030CR	TERMOSTATICI ESTERNI	222,00	380	ABH87118/20BM	ABC	197,00	230
AB87100BM	ABC	201,00	237	ABH87118/20CR	ABC	146,00	230
AB87100CR	ABC	149,00	237	ABH87118/2BM	ABC	124,00	229
AB87108BM	ABC	90,00	237	ABH87118/2CR	ABC	92,00	229
AB87108CR	ABC	67,00	237	ABH87118/4BM	ABC	130,00	229
AB87110/1BM	ABC	213,00	235	ABH87118/4CR	ABC	96,00	229
AB87110/1CR	ABC	158,00	235	ABH87119/1BM	ABC	130,00	234
AB87110BM	ABC	246,00	235	ABH87119/1CR	ABC	96,00	234
AB87110CR	ABC	182,00	235	ABH87119/4BM	ABC	130,00	234
AB87118/10BM	ABC	242,00	235	ABH87119/4CR	ABC	96,00	234
AB87118/10CR	ABC	179,00	235	ABH87128/2BM	ABC	269,00	230
AB87118/1BM	ABC	130,00	229	ABH87128/2CR	ABC	199,00	230
AB87118/1CR	ABC	96,00	229	ACATABOX/PREMIUM	SALA MOSTRA	220,00	533
AB87118/20BM	ABC	197,00	230	ACCP01CGP	NEOCLASSIC	163,00	279
AB87118/20CR	ABC	146,00	230	ACCP01CR	NEOCLASSIC	102,00	279
AB87118/2BM	ABC	124,00	230	ACCP01SB	NEOCLASSIC	163,00	279
AB87118/2CR	ABC	92,00	230	ACCP02CGP	NEOCLASSIC	202,00	279
AB87119/1BM	ABC	130,00	234	ACCP02CR	NEOCLASSIC	126,00	279
AB87119/1CR	ABC	96,00	234	ACCP02SB	NEOCLASSIC	202,00	279
AB87128/2BM	ABC	269,00	231	ACCP11CGP	NEOCLASSIC	163,00	279
AB87128/2CR	ABC	199,00	231	ACCP11CR	NEOCLASSIC	102,00	279
AB87130/30BM	COLONNE MONOCOMANDO	794,00	406	ACCP11SB	NEOCLASSIC	163,00	279
AB87130/30CR	COLONNE MONOCOMANDO	588,00	406	ACCP12CGP	NEOCLASSIC	202,00	279
AB87130/50BM	COLONNE MONOCOMANDO	1.126,00	406	ACCP12CR	NEOCLASSIC	126,00	279
AB87130/50CR	COLONNE MONOCOMANDO	834,00	406	ACCP12SB	NEOCLASSIC	202,00	279
AB87130BM	ABC	175,00	236	ACCP20/300CGP	NEOCLASSIC	224,00	280
AB87130CR	ABC	130,00	236	ACCP20/300CR	NEOCLASSIC	140,00	280
AB87133/10CR	CUCINA SPECIALI	258,00	478	ACCP20/300SB	NEOCLASSIC	224,00	280
AB87198/1BM	ABC	352,00	233	ACCP20/450CGP	NEOCLASSIC	234,00	280
AB87198/1BM	ALLBOX	352,00	297	ACCP20/450CR	NEOCLASSIC	146,00	280
AB87198/1CR	ABC	261,00	233	ACCP20/450SB	NEOCLASSIC	234,00	280
AB87198/1CR	ALLBOX	261,00	297	ACCP20/600CGP	NEOCLASSIC	246,00	281
AB87198BM	ABC	319,00	233	ACCP20/600CR	NEOCLASSIC	154,00	281
AB87198BM	ALLBOX	319,00	296	ACCP20/600SB	NEOCLASSIC	246,00	281
AB87198CR	ABC	236,00	233	ACCP22CGP	NEOCLASSIC	261,00	281
AB87198CR	ALLBOX	236,00	296	ACCP22CR	NEOCLASSIC	163,00	281
AB87199/1BM	ABC	331,00	232	ACCP22SB	NEOCLASSIC	261,00	281
AB87199/1BM	ALLBOX	331,00	296	ACCP25CGP	NEOCLASSIC	176,00	281
AB87199/1CR	ABC	245,00	232	ACCP25CR	NEOCLASSIC	110,00	281
AB87199/1CR	ALLBOX	245,00	296	ACCP25SB	NEOCLASSIC	176,00	281

CODICE	COLLEZIONE	EURO	PAG.	CODICE	COLLEZIONE	EURO	PAG.
ACCP30CGP	NEOCLASSIC	171,00	282	ACPL02WM	ZEN	158,00	265
ACCP30CR	NEOCLASSIC	107,00	282	ACPL11BM	ZEN	188,00	265
ACCP30SB	NEOCLASSIC	171,00	282	ACPL11CGP	ZEN	201,00	265
ACCP41CGP	NEOCLASSIC	261,00	282	ACPL11CR	ZEN	125,00	265
ACCP41CR	NEOCLASSIC	163,00	282	ACPL11GUP	ZEN	201,00	265
ACCP41SB	NEOCLASSIC	261,00	282	ACPL11IX	ZEN	188,00	265
ACCP42CGP	NEOCLASSIC	298,00	282	ACPL11RCP	ZEN	201,00	265
ACCP42CR	NEOCLASSIC	186,00	282	ACPL11RTP	ZEN	201,00	265
ACCP42SB	NEOCLASSIC	298,00	282	ACPL11SB	ZEN	201,00	265
ACCP50CGP	NEOCLASSIC	77,00	282	ACPL11WM	ZEN	188,00	265
ACCP50CR	NEOCLASSIC	48,00	282	ACPL12BM	ZEN	188,00	265
ACCP50SB	NEOCLASSIC	77,00	282	ACPL12CGP	ZEN	201,00	265
ACCP61CGP	NEOCLASSIC	227,00	280	ACPL12CR	ZEN	125,00	265
ACCP61CR	NEOCLASSIC	142,00	280	ACPL12GUP	ZEN	201,00	265
ACCP61SB	NEOCLASSIC	227,00	280	ACPL12IX	ZEN	188,00	265
ACCP62CGP	NEOCLASSIC	267,00	280	ACPL12RCP	ZEN	201,00	265
ACCP62CR	NEOCLASSIC	167,00	280	ACPL12RTP	ZEN	201,00	265
ACCP62SB	NEOCLASSIC	267,00	280	ACPL12SB	ZEN	201,00	265
ACCP70CGP	NEOCLASSIC	590,00	281	ACPL12WM	ZEN	188,00	265
ACCP70CR	NEOCLASSIC	369,00	281	ACPL20/335BM	ZEN	158,00	266
ACCP70SB	NEOCLASSIC	590,00	281	ACPL20/335CGP	ZEN	167,00	266
ACLP01CR	TODAY	114,00	273	ACPL20/335CR	ZEN	105,00	266
ACLP02CR	TODAY	93,00	273	ACPL20/335GUP	ZEN	167,00	266
ACLP11CR	TODAY	120,00	273	ACPL20/335IX	ZEN	158,00	266
ACLP12CR	TODAY	122,00	273	ACPL20/335RCP	ZEN	167,00	266
ACLP20/400CR	TODAY	138,00	274	ACPL20/335RTP	ZEN	167,00	266
ACLP20/500CR	TODAY	156,00	274	ACPL20/335SB	ZEN	167,00	266
ACLP20/600CR	TODAY	160,00	275	ACPL20/335WM	ZEN	142,00	266
ACLP20/800CR	TODAY	172,00	275	ACPL20/485BM	ZEN	168,00	266
ACLP22/2XCR	TODAY	207,00	275	ACPL20/485CGP	ZEN	180,00	266
ACLP22CR	TODAY	139,00	275	ACPL20/485CR	ZEN	111,00	266
ACLP24CR	TODAY	485,00	276	ACPL20/485GUP	ZEN	180,00	266
ACLP25CR	TODAY	156,00	276	ACPL20/485IX	ZEN	168,00	266
ACLP30/COCR	TODAY	189,00	277	ACPL20/485RCP	ZEN	180,00	266
ACLP30CR	TODAY	96,00	277	ACPL20/485RTP	ZEN	180,00	266
ACLP41CR	TODAY	208,00	277	ACPL20/485SB	ZEN	180,00	266
ACLP42CR	TODAY	224,00	277	ACPL20/485WM	ZEN	168,00	266
ACLP50CR	TODAY	64,00	276	ACPL20/635BM	ZEN	188,00	267
ACLP61CR	TODAY	213,00	274	ACPL20/635CGP	ZEN	201,00	267
ACLP62CR	TODAY	213,00	274	ACPL20/635CR	ZEN	125,00	267
ACLP70/600CR	TODAY	185,00	276	ACPL20/635GUP	ZEN	201,00	267
ACPL01BM	ZEN	166,00	265	ACPL20/635IX	ZEN	188,00	267
ACPL01CGP	ZEN	177,00	265	ACPL20/635RCP	ZEN	201,00	267
ACPL01CR	ZEN	110,00	265	ACPL20/635RTP	ZEN	201,00	267
ACPL01GUP	ZEN	177,00	265	ACPL20/635SB	ZEN	201,00	267
ACPL01IX	ZEN	166,00	265	ACPL20/635WM	ZEN	188,00	267
ACPL01RCP	ZEN	177,00	265	ACPL21BM	ZEN	142,00	267
ACPL01RTP	ZEN	177,00	265	ACPL21CGP	ZEN	151,00	267
ACPL01SB	ZEN	177,00	265	ACPL21CR	ZEN	95,00	267
ACPL01WM	ZEN	166,00	265	ACPL21GUP	ZEN	151,00	267
ACPL02BM	ZEN	158,00	265	ACPL21RCP	ZEN	151,00	267
ACPL02CGP	ZEN	167,00	265	ACPL21RTP	ZEN	151,00	267
ACPL02CR	ZEN	105,00	265	ACPL21SB	ZEN	151,00	267
ACPL02GUP	ZEN	167,00	265	ACPL21WM	ZEN	142,00	267
ACPL02IX	ZEN	158,00	265	ACPL22/2XBM	ZEN	188,00	267
ACPL02RCP	ZEN	167,00	265	ACPL22/2XCGP	ZEN	201,00	267
ACPL02RTP	ZEN	167,00	265	ACPL22/2XCR	ZEN	125,00	267
ACPL02SB	ZEN	167,00	265	ACPL22/2XGUP	ZEN	201,00	267



CODICE	COLLEZIONE	EURO	PAG.	CODICE	COLLEZIONE	EURO	PAG.
ACPL22/2XIX	ZEN	188,00	267	ACPL41/465BM	ZEN	195,00	269
ACPL22/2XRCP	ZEN	201,00	267	ACPL41/465CGP	ZEN	208,00	269
ACPL22/2XRTP	ZEN	201,00	267	ACPL41/465CR	ZEN	130,00	269
ACPL22/2XSB	ZEN	201,00	267	ACPL41/465GUP	ZEN	208,00	269
ACPL22/2XWM	ZEN	188,00	267	ACPL41/465IX	ZEN	195,00	269
ACPL23/2XBM	ZEN	271,00	268	ACPL41/465RCP	ZEN	208,00	269
ACPL23/2XCGRP	ZEN	288,00	268	ACPL41/465RTP	ZEN	208,00	269
ACPL23/2XCR	ZEN	181,00	268	ACPL41/465SB	ZEN	208,00	269
ACPL23/2XGUP	ZEN	288,00	268	ACPL41/465WM	ZEN	195,00	269
ACPL23/2XRCP	ZEN	288,00	268	ACPL42BM	ZEN	228,00	270
ACPL23/2XRTP	ZEN	288,00	268	ACPL42CGP	ZEN	244,00	270
ACPL23/2XSB	ZEN	288,00	268	ACPL42CR	ZEN	152,00	270
ACPL23/2XWM	ZEN	271,00	268	ACPL42GUP	ZEN	244,00	270
ACPL24BM	ZEN	461,00	268	ACPL42IX	ZEN	228,00	270
ACPL24CGP	ZEN	490,00	268	ACPL42RCP	ZEN	244,00	270
ACPL24CR	ZEN	307,00	268	ACPL42RTP	ZEN	244,00	270
ACPL24GUP	ZEN	490,00	268	ACPL42SB	ZEN	244,00	270
ACPL24IX	ZEN	461,00	268	ACPL42WM	ZEN	228,00	270
ACPL24RCP	ZEN	490,00	268	ACPL50BM	ZEN	78,00	268
ACPL24RTP	ZEN	490,00	268	ACPL50CGP	ZEN	83,00	268
ACPL24SB	ZEN	490,00	268	ACPL50CR	ZEN	51,00	268
ACPL24WM	ZEN	461,00	268	ACPL50GUP	ZEN	83,00	268
ACPL25BM	ZEN	195,00	267	ACPL50IX	ZEN	78,00	268
ACPL25CGP	ZEN	208,00	267	ACPL50RCP	ZEN	83,00	268
ACPL25CR	ZEN	130,00	267	ACPL50RTP	ZEN	83,00	268
ACPL25GUP	ZEN	208,00	267	ACPL50SB	ZEN	83,00	268
ACPL25IX	ZEN	195,00	267	ACPL50WM	ZEN	78,00	268
ACPL25RCP	ZEN	208,00	267	ACPL61BM	ZEN	158,00	266
ACPL25RTP	ZEN	208,00	267	ACPL61CGP	ZEN	167,00	266
ACPL25SB	ZEN	208,00	267	ACPL61CR	ZEN	105,00	266
ACPL25WM	ZEN	195,00	267	ACPL61GUP	ZEN	167,00	266
ACPL30/2XBM	ZEN	140,00	269	ACPL61IX	ZEN	158,00	266
ACPL30/2XCGRP	ZEN	149,00	269	ACPL61RCP	ZEN	167,00	266
ACPL30/2XCR	ZEN	93,00	269	ACPL61RTP	ZEN	167,00	266
ACPL30/2XGUP	ZEN	149,00	269	ACPL61SB	ZEN	167,00	266
ACPL30/2XIX	ZEN	140,00	269	ACPL61WM	ZEN	158,00	266
ACPL30/2XRCP	ZEN	149,00	269	ACPL62BM	ZEN	234,00	266
ACPL30/2XRTP	ZEN	149,00	269	ACPL62CGP	ZEN	249,00	266
ACPL30/2XSB	ZEN	149,00	269	ACPL62CR	ZEN	156,00	266
ACPL30/2XWM	ZEN	140,00	269	ACPL62GUP	ZEN	249,00	266
ACPL30/DXBM	ZEN	122,00	269	ACPL62IX	ZEN	234,00	266
ACPL30/DXCGP	ZEN	130,00	269	ACPL62RCP	ZEN	249,00	266
ACPL30/DXCR	ZEN	82,00	269	ACPL62RTP	ZEN	249,00	266
ACPL30/DXGUP	ZEN	130,00	269	ACPL62SB	ZEN	249,00	266
ACPL30/DXIX	ZEN	122,00	269	ACPL62WM	ZEN	234,00	266
ACPL30/DXRCP	ZEN	130,00	269	ACPL80/2XBM	ZEN	1.148,00	268
ACPL30/DXRTP	ZEN	130,00	269	ACPL80/2XCGRP	ZEN	1.224,00	268
ACPL30/DXSB	ZEN	130,00	269	ACPL80/2XCR	ZEN	764,00	268
ACPL30/DXWM	ZEN	122,00	269	ACPL80/2XGUP	ZEN	1.224,00	268
ACPL30/SXBM	ZEN	122,00	269	ACPL80/2XRCP	ZEN	1.224,00	268
ACPL30/SXCGP	ZEN	130,00	269	ACPL80/2XRTP	ZEN	1.224,00	268
ACPL30/SXCR	ZEN	82,00	269	ACPL80/2XSB	ZEN	1.224,00	268
ACPL30/SXGUP	ZEN	130,00	269	ACPL80/2XWM	ZEN	1.148,00	268
ACPL30/SXIX	ZEN	122,00	269	ACPL92BM	ZEN	517,00	270
ACPL30/SXRCP	ZEN	130,00	269	ACPL92CGP	ZEN	552,00	270
ACPL30/SXRTP	ZEN	130,00	269	ACPL92CR	ZEN	345,00	270
ACPL30/SXSB	ZEN	130,00	269	ACPL92GUP	ZEN	552,00	270
ACPL30/SXWM	ZEN	122,00	269	ACPL92RCP	ZEN	552,00	270

CODICE	COLLEZIONE	EURO	PAG.	CODICE	COLLEZIONE	EURO	PAG.
ACPL92RTP	ZEN	552,00	270	AD138/60SB	COMPONENTI DOCCIA	262,00	351
ACPL92SB	ZEN	552,00	270	AD138/61CR	COMPONENTI DOCCIA	152,00	353
ACPL92WM	ZEN	517,00	270	AD138/62CR	COMPONENTI DOCCIA	180,00	353
AD135/43CR	COMPONENTI DOCCIA	23,00	375	AD138/63CR	COMPONENTI DOCCIA	152,00	352
AD135/43IX	COMPONENTI DOCCIA	37,00	375	AD138/64BM	COMPONENTI DOCCIA	223,00	352
AD135/57BM	COMPONENTI DOCCIA	37,00	375	AD138/64CGP	VELIS	238,00	61
AD135/57WM	COMPONENTI DOCCIA	37,00	375	AD138/64CGP	COMPONENTI DOCCIA	238,00	352
AD135/58CR	COMPONENTI DOCCIA	21,00	375	AD138/64CR	SOLE	149,00	39
AD135/5CGP	COMPONENTI DOCCIA	67,00	375	AD138/64CR	VELIS	149,00	61
AD135/5CR	COMPONENTI DOCCIA	42,00	375	AD138/64CR	COMPONENTI DOCCIA	149,00	352
AD135/5SB	COMPONENTI DOCCIA	67,00	375	AD138/64GUP	SOLE	238,00	39
AD138/20CR	COMPONENTI DOCCIA	158,00	352	AD138/64GUP	VELIS	238,00	61
AD138/24BM	COMPONENTI DOCCIA	182,00	350	AD138/64GUP	COMPONENTI DOCCIA	238,00	352
AD138/24CR	COMPONENTI DOCCIA	122,00	350	AD138/64IX	SOLE	223,00	39
AD138/24IX	COMPONENTI DOCCIA	182,00	350	AD138/64IX	VELIS	223,00	61
AD138/40BM	COMPONENTI DOCCIA	76,00	351	AD138/64IX	COMPONENTI DOCCIA	223,00	352
AD138/40CGP	COMPONENTI DOCCIA	82,00	351	AD138/64RCP	VELIS	238,00	61
AD138/40CR	COMPONENTI DOCCIA	51,00	351	AD138/64RCP	COMPONENTI DOCCIA	238,00	352
AD138/40GUP	COMPONENTI DOCCIA	82,00	351	AD138/64RTP	SOLE	238,00	39
AD138/40IX	COMPONENTI DOCCIA	76,00	351	AD138/64RTP	VELIS	238,00	61
AD138/40RCP	COMPONENTI DOCCIA	82,00	351	AD138/64RTP	COMPONENTI DOCCIA	238,00	352
AD138/40RTP	COMPONENTI DOCCIA	82,00	351	AD138/64SB	SOLE	238,00	39
AD138/40SB	COMPONENTI DOCCIA	82,00	351	AD138/64SB	VELIS	238,00	61
AD138/40WM	COMPONENTI DOCCIA	76,00	351	AD138/64SB	COMPONENTI DOCCIA	238,00	352
AD138/42CR	COMPONENTI DOCCIA	148,00	350	AD138/64WM	COMPONENTI DOCCIA	223,00	352
AD138/43CR	COMPONENTI DOCCIA	131,00	350	AD138/65CR	COMPONENTI DOCCIA	152,00	354
AD138/44BM	COMPONENTI DOCCIA	135,00	349	AD138/66BM	COMPONENTI DOCCIA	269,00	353
AD138/44CGP	VELIS	146,00	61	AD138/66CR	COMPONENTI DOCCIA	180,00	353
AD138/44CGP	COMPONENTI DOCCIA	146,00	349	AD138/66IX	COMPONENTI DOCCIA	269,00	353
AD138/44CR	SOLE	90,00	39	AD139/100BM	COMPONENTI DOCCIA	1.316,00	341
AD138/44CR	VELIS	90,00	61	AD139/100CGP	COMPONENTI DOCCIA	1.347,00	341
AD138/44CR	COMPONENTI DOCCIA	90,00	349	AD139/100CR	COMPONENTI DOCCIA	842,00	341
AD138/44GUP	SOLE	146,00	39	AD139/100GUP	COMPONENTI DOCCIA	1.347,00	341
AD138/44GUP	VELIS	146,00	61	AD139/100IX	COMPONENTI DOCCIA	1.316,00	341
AD138/44GUP	COMPONENTI DOCCIA	146,00	349	AD139/100RCP	COMPONENTI DOCCIA	1.347,00	341
AD138/44IX	SOLE	135,00	39	AD139/100RTP	COMPONENTI DOCCIA	1.347,00	341
AD138/44IX	VELIS	135,00	61	AD139/100SB	COMPONENTI DOCCIA	1.347,00	341
AD138/44IX	COMPONENTI DOCCIA	135,00	349	AD139/100WM	COMPONENTI DOCCIA	1.316,00	341
AD138/44RCP	VELIS	146,00	61	AD139/101BM	COMPONENTI DOCCIA	1.563,00	341
AD138/44RCP	COMPONENTI DOCCIA	146,00	349	AD139/101CR	COMPONENTI DOCCIA	1.071,00	341
AD138/44RTP	SOLE	146,00	39	AD139/102BM	COMPONENTI DOCCIA	1.811,00	340
AD138/44RTP	VELIS	146,00	61	AD139/102CGP	COMPONENTI DOCCIA	2.174,00	340
AD138/44RTP	COMPONENTI DOCCIA	146,00	349	AD139/102CR	COMPONENTI DOCCIA	1.208,00	340
AD138/44SB	SOLE	146,00	39	AD139/102GUP	COMPONENTI DOCCIA	2.174,00	340
AD138/44SB	VELIS	146,00	61	AD139/102IX	COMPONENTI DOCCIA	1.811,00	340
AD138/44SB	COMPONENTI DOCCIA	146,00	349	AD139/102RCP	COMPONENTI DOCCIA	2.174,00	340
AD138/44WM	COMPONENTI DOCCIA	135,00	349	AD139/102RTP	COMPONENTI DOCCIA	2.174,00	340
AD138/4CGP	COMPONENTI DOCCIA	131,00	351	AD139/102SB	COMPONENTI DOCCIA	2.174,00	340
AD138/4CR	COMPONENTI DOCCIA	82,00	351	AD139/103CR	COMPONENTI DOCCIA	1.347,00	340
AD138/4SB	COMPONENTI DOCCIA	131,00	351	AD139/104BM	COMPONENTI DOCCIA	1.316,00	340
AD138/50CR	COMPONENTI DOCCIA	264,00	354	AD139/104CGP	COMPONENTI DOCCIA	1.347,00	340
AD138/51CR	COMPONENTI DOCCIA	291,00	353	AD139/104CR	COMPONENTI DOCCIA	842,00	340
AD138/54CR	COMPONENTI DOCCIA	228,00	350	AD139/104GUP	COMPONENTI DOCCIA	1.347,00	340
AD138/55CR	COMPONENTI DOCCIA	213,00	352	AD139/104IX	COMPONENTI DOCCIA	1.316,00	340
AD138/56CR	COMPONENTI DOCCIA	255,00	351	AD139/104RCP	COMPONENTI DOCCIA	1.347,00	340
AD138/59CR	COMPONENTI DOCCIA	205,00	349	AD139/104RTP	COMPONENTI DOCCIA	1.347,00	340
AD138/60CGP	COMPONENTI DOCCIA	262,00	351	AD139/104SB	COMPONENTI DOCCIA	1.347,00	340
AD138/60CR	COMPONENTI DOCCIA	164,00	351	AD139/104WM	COMPONENTI DOCCIA	1.316,00	340

CODICE	COLLEZIONE	EURO	PAG.	CODICE	COLLEZIONE	EURO	PAG.
AD139/105CR	COMPONENTI DOCCIA	1.089,00	340	AD139/138IX	COMPONENTI DOCCIA	1.950,00	346
AD139/108CR	COMPONENTI DOCCIA	227,00	348	AD139/138RTP	SOLE	2.080,00	39
AD139/109CR	COMPONENTI DOCCIA	433,00	347	AD139/138RTP	COMPONENTI DOCCIA	2.080,00	346
AD139/10CBM	COMPONENTI DOCCIA	243,00	344	AD139/138SB	SOLE	2.080,00	39
AD139/10CCGP	COMPONENTI DOCCIA	254,00	344	AD139/138SB	COMPONENTI DOCCIA	2.080,00	346
AD139/10CCR	COMPONENTI DOCCIA	218,00	344	AD139/139BM	COMPONENTI DOCCIA	1.490,00	342
AD139/10CGUP	COMPONENTI DOCCIA	254,00	344	AD139/139CR	COMPONENTI DOCCIA	993,00	342
AD139/10CIX	COMPONENTI DOCCIA	243,00	344	AD139/139IX	COMPONENTI DOCCIA	1.490,00	342
AD139/10CR	COMPONENTI DOCCIA	149,00	345	AD139/139SB	COMPONENTI DOCCIA	1.589,00	342
AD139/10CRCP	COMPONENTI DOCCIA	254,00	344	AD139/139WM	COMPONENTI DOCCIA	1.490,00	342
AD139/10CRTP	COMPONENTI DOCCIA	254,00	344	AD139/140BM	COMPONENTI DOCCIA	195,00	345
AD139/10CSB	COMPONENTI DOCCIA	254,00	344	AD139/140CGP	COMPONENTI DOCCIA	208,00	345
AD139/10CWM	COMPONENTI DOCCIA	243,00	344	AD139/140CR	COMPONENTI DOCCIA	130,00	345
AD139/110CR	COMPONENTI DOCCIA	660,00	347	AD139/140GUP	COMPONENTI DOCCIA	208,00	345
AD139/111CR	COMPONENTI DOCCIA	842,00	347	AD139/140IX	COMPONENTI DOCCIA	195,00	345
AD139/112BM	COMPONENTI DOCCIA	228,00	344	AD139/140RCP	COMPONENTI DOCCIA	208,00	345
AD139/112CGP	COMPONENTI DOCCIA	274,00	344	AD139/140RTP	COMPONENTI DOCCIA	208,00	345
AD139/112CR	COMPONENTI DOCCIA	152,00	344	AD139/140SB	COMPONENTI DOCCIA	208,00	345
AD139/112GUP	COMPONENTI DOCCIA	274,00	344	AD139/140WM	COMPONENTI DOCCIA	195,00	345
AD139/112IX	COMPONENTI DOCCIA	228,00	344	AD139/141BM	COMPONENTI DOCCIA	162,00	345
AD139/112RCP	COMPONENTI DOCCIA	274,00	344	AD139/141CGP	COMPONENTI DOCCIA	175,00	345
AD139/112RTP	COMPONENTI DOCCIA	274,00	344	AD139/141CR	COMPONENTI DOCCIA	108,00	345
AD139/112SB	COMPONENTI DOCCIA	274,00	344	AD139/141GUP	COMPONENTI DOCCIA	175,00	345
AD139/112WM	COMPONENTI DOCCIA	228,00	344	AD139/141IX	COMPONENTI DOCCIA	162,00	345
AD139/113CR	COMPONENTI DOCCIA	415,00	343	AD139/141RCP	COMPONENTI DOCCIA	175,00	345
AD139/114CR	COMPONENTI DOCCIA	629,00	343	AD139/141RTP	COMPONENTI DOCCIA	175,00	345
AD139/115CR	COMPONENTI DOCCIA	820,00	343	AD139/141SB	COMPONENTI DOCCIA	175,00	345
AD139/121BM	COMPONENTI DOCCIA	198,00	344	AD139/141WM	COMPONENTI DOCCIA	162,00	345
AD139/121CR	COMPONENTI DOCCIA	132,00	344	AD139/142BM	COMPONENTI DOCCIA	254,00	344
AD139/122BM	COMPONENTI DOCCIA	308,00	346	AD139/142CGP	COMPONENTI DOCCIA	286,00	344
AD139/122CR	COMPONENTI DOCCIA	205,00	346	AD139/142CR	COMPONENTI DOCCIA	169,00	344
AD139/122IX	COMPONENTI DOCCIA	308,00	346	AD139/142GUP	COMPONENTI DOCCIA	286,00	344
AD139/129CR	COMPONENTI DOCCIA	324,00	346	AD139/142IX	COMPONENTI DOCCIA	254,00	344
AD139/12CGP	COMPONENTI DOCCIA	387,00	349	AD139/142RCP	COMPONENTI DOCCIA	286,00	344
AD139/12CR	COMPONENTI DOCCIA	242,00	349	AD139/142RTP	COMPONENTI DOCCIA	286,00	344
AD139/12SB	COMPONENTI DOCCIA	387,00	349	AD139/142SB	COMPONENTI DOCCIA	286,00	344
AD139/130BM	COMPONENTI DOCCIA	1.599,00	341	AD139/142WM	COMPONENTI DOCCIA	254,00	344
AD139/130CR	COMPONENTI DOCCIA	1.066,00	341	AD139/17CBM	COMPONENTI DOCCIA	287,00	348
AD139/130IX	COMPONENTI DOCCIA	1.599,00	341	AD139/17CCR	COMPONENTI DOCCIA	259,00	348
AD139/130SB	COMPONENTI DOCCIA	1.706,00	341	AD139/17CIX	COMPONENTI DOCCIA	287,00	348
AD139/130WM	COMPONENTI DOCCIA	1.599,00	341	AD139/17CR	COMPONENTI DOCCIA	188,00	349
AD139/132CR	COMPONENTI DOCCIA	260,00	347	AD139/34CCR	COMPONENTI DOCCIA	558,00	341
AD139/134CR	COMPONENTI DOCCIA	164,00	348	AD139/63BM	COMPONENTI DOCCIA	471,00	343
AD139/137CR	SOLE	214,00	39	AD139/63CGP	VELIS	566,00	62
AD139/137CR	COMPONENTI DOCCIA	214,00	342	AD139/63CGP	COMPONENTI DOCCIA	566,00	343
AD139/137GUP	SOLE	342,00	39	AD139/63CR	VELIS	314,00	62
AD139/137GUP	COMPONENTI DOCCIA	342,00	342	AD139/63CR	COMPONENTI DOCCIA	314,00	343
AD139/137IX	SOLE	321,00	39	AD139/63GUP	VELIS	566,00	62
AD139/137IX	COMPONENTI DOCCIA	321,00	342	AD139/63GUP	COMPONENTI DOCCIA	566,00	343
AD139/137RTP	SOLE	342,00	39	AD139/63IX	VELIS	471,00	62
AD139/137RTP	COMPONENTI DOCCIA	342,00	342	AD139/63IX	COMPONENTI DOCCIA	471,00	343
AD139/137SB	SOLE	342,00	39	AD139/63RCP	VELIS	566,00	62
AD139/137SB	COMPONENTI DOCCIA	342,00	342	AD139/63RCP	COMPONENTI DOCCIA	566,00	343
AD139/138CR	SOLE	1.300,00	39	AD139/63RTP	VELIS	566,00	62
AD139/138CR	COMPONENTI DOCCIA	1.300,00	346	AD139/63RTP	COMPONENTI DOCCIA	566,00	343
AD139/138GUP	SOLE	2.080,00	39	AD139/63SB	VELIS	566,00	62
AD139/138GUP	COMPONENTI DOCCIA	2.080,00	346	AD139/63SB	COMPONENTI DOCCIA	566,00	343
AD139/138IX	SOLE	1.950,00	39	AD139/63WM	COMPONENTI DOCCIA	471,00	343

CODICE	COLLEZIONE	EURO	PAG.	CODICE	COLLEZIONE	EURO	PAG.
AD139/64BM	COMPONENTI DOCCIA	417,00	348	AD140/55RCR	COMPONENTI DOCCIA	78,00	373
AD139/64CR	COMPONENTI DOCCIA	278,00	348	AD140/56RCR	COMPONENTI DOCCIA	281,00	374
AD139/64IX	COMPONENTI DOCCIA	417,00	348	AD140/60CR	COMPONENTI DOCCIA	62,00	363
AD139/79CR	COMPONENTI DOCCIA	221,00	346	AD140/61CR	COMPONENTI DOCCIA	65,00	362
AD139/90CR	COMPONENTI DOCCIA	2.800,00	339	AD140/62CR	COMPONENTI DOCCIA	80,00	362
AD139/91CR	COMPONENTI DOCCIA	3.919,00	339	AD140/63CR	COMPONENTI DOCCIA	75,00	363
AD139/92CR	COMPONENTI DOCCIA	3.513,00	339	AD141/10CGP	GRAZIA	1.472,00	217
AD139/93CR	COMPONENTI DOCCIA	4.038,00	339	AD141/10CR	GRAZIA	920,00	217
AD140/10CGP	COMPONENTI DOCCIA	434,00	364	AD142/124CR	COMPONENTI DOCCIA	82,00	369
AD140/10CR	COMPONENTI DOCCIA	271,00	364	AD142/130CCR	COMPONENTI DOCCIA	67,00	367
AD140/10RCGP	COMPONENTI DOCCIA	325,00	374	AD142/143CR	COMPONENTI DOCCIA	80,00	366
AD140/10RCR	COMPONENTI DOCCIA	203,00	374	AD142/145CR	COMPONENTI DOCCIA	22,00	368
AD140/10RSB	COMPONENTI DOCCIA	325,00	374	AD142/153CGP	COMPONENTI DOCCIA	272,00	369
AD140/18CR	COMPONENTI DOCCIA	148,00	363	AD142/153CR	COMPONENTI DOCCIA	170,00	369
AD140/18RCR	COMPONENTI DOCCIA	78,00	374	AD142/153SB	COMPONENTI DOCCIA	272,00	369
AD140/21BM	COMPONENTI DOCCIA	457,00	364	AD142/161CR	COMPONENTI DOCCIA	70,00	367
AD140/21CR	COMPONENTI DOCCIA	305,00	364	AD142/178CR	COMPONENTI DOCCIA	40,00	366
AD140/21IX	COMPONENTI DOCCIA	457,00	364	AD142/179CR	COMPONENTI DOCCIA	96,00	366
AD140/21RBM	COMPONENTI DOCCIA	355,00	374	AD142/186CR	COMPONENTI DOCCIA	23,00	367
AD140/21RCR	COMPONENTI DOCCIA	237,00	374	AD142/188CR	COMPONENTI DOCCIA	42,00	365
AD140/21RIX	COMPONENTI DOCCIA	355,00	374	AD142/189CR	COMPONENTI DOCCIA	38,00	366
AD140/26CR	COMPONENTI DOCCIA	255,00	361	AD142/200BM	COMPONENTI DOCCIA	68,00	368
AD140/28CR	COMPONENTI DOCCIA	302,00	360	AD142/200CR	COMPONENTI DOCCIA	45,00	368
AD140/34CR	COMPONENTI DOCCIA	180,00	362	AD142/201BM	COMPONENTI DOCCIA	140,00	365
AD140/36CR	COMPONENTI DOCCIA	139,00	361	AD142/201CR	COMPONENTI DOCCIA	93,00	365
AD140/37BM	COMPONENTI DOCCIA	208,00	363	AD142/201GUP	COMPONENTI DOCCIA	149,00	365
AD140/37CGP	VELIS	223,00	63	AD142/31CGP	COMPONENTI DOCCIA	74,00	369
AD140/37CGP	COMPONENTI DOCCIA	223,00	363	AD142/31CR	COMPONENTI DOCCIA	46,00	369
AD140/37CR	VELIS	139,00	63	AD142/67BM	COMPONENTI DOCCIA	74,00	368
AD140/37CR	COMPONENTI DOCCIA	139,00	363	AD142/67CR	COMPONENTI DOCCIA	48,00	368
AD140/37GUP	VELIS	223,00	63	AD142/67IX	COMPONENTI DOCCIA	74,00	368
AD140/37GUP	COMPONENTI DOCCIA	223,00	363	AD142/80CR	COMPONENTI DOCCIA	47,00	367
AD140/37IX	VELIS	208,00	63	AD142/91BM	COMPONENTI DOCCIA	63,00	368
AD140/37IX	COMPONENTI DOCCIA	208,00	363	AD142/91CGP	COMPONENTI DOCCIA	67,00	368
AD140/37RCP	VELIS	223,00	63	AD142/91CR	COMPONENTI DOCCIA	42,00	368
AD140/37RCP	COMPONENTI DOCCIA	223,00	363	AD142/91GUP	COMPONENTI DOCCIA	67,00	368
AD140/37RTP	VELIS	223,00	63	AD142/91IX	COMPONENTI DOCCIA	63,00	368
AD140/37RTP	COMPONENTI DOCCIA	223,00	363	AD142/91RCP	COMPONENTI DOCCIA	67,00	368
AD140/37SB	VELIS	223,00	63	AD142/91RTP	COMPONENTI DOCCIA	67,00	368
AD140/37SB	COMPONENTI DOCCIA	223,00	363	AD142/91SB	COMPONENTI DOCCIA	67,00	368
AD140/37WM	COMPONENTI DOCCIA	208,00	363	AD142/91WM	COMPONENTI DOCCIA	63,00	368
AD140/39CR	COMPONENTI DOCCIA	120,00	362	AD143/6CGP	COMPONENTI DOCCIA	190,00	358
AD140/40CR	COMPONENTI DOCCIA	120,00	365	AD143/6CR	COMPONENTI DOCCIA	119,00	358
AD140/41CR	COMPONENTI DOCCIA	137,00	365	AD143/7CGP	COMPONENTI DOCCIA	392,00	358
AD140/48CGP	COMPONENTI DOCCIA	630,00	364	AD143/7CR	COMPONENTI DOCCIA	245,00	358
AD140/48CR	COMPONENTI DOCCIA	394,00	364	AD143/7SB	COMPONENTI DOCCIA	392,00	358
AD140/48SB	COMPONENTI DOCCIA	630,00	364	AD144/4CR	COMPONENTI DOCCIA	66,00	359
AD140/51CR	COMPONENTI DOCCIA	128,00	361	AD144/5CGP	COMPONENTI DOCCIA	186,00	360
AD140/51RBM	COMPONENTI DOCCIA	113,00	373	AD144/5CR	COMPONENTI DOCCIA	116,00	360
AD140/51RCR	COMPONENTI DOCCIA	75,00	373	AD144/6CGP	COMPONENTI DOCCIA	347,00	360
AD140/51RGUP	COMPONENTI DOCCIA	120,00	373	AD144/6CR	COMPONENTI DOCCIA	217,00	360
AD140/51RIX	COMPONENTI DOCCIA	113,00	373	AD144/6SB	COMPONENTI DOCCIA	347,00	360
AD140/51RWM	COMPONENTI DOCCIA	113,00	373	AD146/18CR	COMPONENTI DOCCIA	93,00	359
AD140/53BM	COMPONENTI DOCCIA	213,00	364	AD146/24BM	COMPONENTI DOCCIA	169,00	360
AD140/53CR	COMPONENTI DOCCIA	142,00	364	AD146/24CR	COMPONENTI DOCCIA	113,00	360
AD140/54BM	COMPONENTI DOCCIA	286,00	361	AD146/24IX	COMPONENTI DOCCIA	169,00	360
AD140/54CR	COMPONENTI DOCCIA	190,00	361	AD146/25BM	COMPONENTI DOCCIA	140,00	359
AD140/54GUP	COMPONENTI DOCCIA	304,00	361	AD146/25CR	COMPONENTI DOCCIA	93,00	359

CODICE	COLLEZIONE	EURO	PAG.	CODICE	COLLEZIONE	EURO	PAG.
AD146/26BM	COMPONENTI DOCCIA	135,00	359	AD146/54SB	SOLE	432,00	40
AD146/26CGP	VELIS	144,00	62	AD146/54SB	COMPONENTI DOCCIA	432,00	356
AD146/26CGP	COMPONENTI DOCCIA	144,00	359	AD147/1CR	COMPONENTI DOCCIA	15,00	373
AD146/26CR	VELIS	89,00	62	AD147/23BM	COMPONENTI DOCCIA	63,00	372
AD146/26CR	COMPONENTI DOCCIA	89,00	359	AD147/23CR	COMPONENTI DOCCIA	42,00	372
AD146/26GUP	VELIS	144,00	62	AD147/23IX	COMPONENTI DOCCIA	63,00	372
AD146/26GUP	COMPONENTI DOCCIA	144,00	359	AD147/24CR	COMPONENTI DOCCIA	15,00	372
AD146/26IX	VELIS	135,00	62	AD147/2CR	COMPONENTI DOCCIA	23,00	372
AD146/26IX	COMPONENTI DOCCIA	135,00	359	AD147/4BM	COMPONENTI DOCCIA	40,00	371
AD146/26RCP	VELIS	144,00	62	AD147/4CGP	COMPONENTI DOCCIA	42,00	371
AD146/26RCP	COMPONENTI DOCCIA	144,00	359	AD147/4CR	COMPONENTI DOCCIA	25,00	371
AD146/26RTP	VELIS	144,00	62	AD147/4GUP	COMPONENTI DOCCIA	42,00	371
AD146/26RTP	COMPONENTI DOCCIA	144,00	359	AD147/4IX	COMPONENTI DOCCIA	40,00	371
AD146/26SB	VELIS	144,00	62	AD147/4RCP	COMPONENTI DOCCIA	42,00	371
AD146/26SB	COMPONENTI DOCCIA	144,00	359	AD147/4RTP	COMPONENTI DOCCIA	42,00	371
AD146/26WM	COMPONENTI DOCCIA	135,00	359	AD147/4SB	COMPONENTI DOCCIA	42,00	371
AD146/27CR	COMPONENTI DOCCIA	86,00	357	AD147/4WM	COMPONENTI DOCCIA	40,00	371
AD146/31CR	COMPONENTI DOCCIA	132,00	357	AD147/9CR	COMPONENTI DOCCIA	6,00	373
AD146/32BM	COMPONENTI DOCCIA	172,00	357	AD148/1CGP	COMPONENTI DOCCIA	74,00	372
AD146/32CGP	VELIS	184,00	62	AD148/1CR	COMPONENTI DOCCIA	46,00	372
AD146/32CGP	COMPONENTI DOCCIA	184,00	357	AD148/1SB	COMPONENTI DOCCIA	74,00	372
AD146/32CR	VELIS	116,00	62	AD149CGP	COMPONENTI DOCCIA	77,00	371
AD146/32CR	COMPONENTI DOCCIA	116,00	357	AD149CR	COMPONENTI DOCCIA	48,00	371
AD146/32GUP	VELIS	184,00	62	AD149SB	COMPONENTI DOCCIA	77,00	371
AD146/32GUP	COMPONENTI DOCCIA	184,00	357	AD150/12BM	COMPONENTI DOCCIA	74,00	369
AD146/32IX	VELIS	172,00	62	AD150/12CGP	VELIS	79,00	63
AD146/32IX	COMPONENTI DOCCIA	172,00	357	AD150/12CGP	COMPONENTI DOCCIA	79,00	369
AD146/32RCP	VELIS	184,00	62	AD150/12CR	VELIS	48,00	63
AD146/32RCP	COMPONENTI DOCCIA	184,00	357	AD150/12CR	COMPONENTI DOCCIA	48,00	369
AD146/32RTP	VELIS	184,00	62	AD150/12GUP	VELIS	79,00	63
AD146/32RTP	COMPONENTI DOCCIA	184,00	357	AD150/12GUP	COMPONENTI DOCCIA	79,00	369
AD146/32SB	VELIS	184,00	62	AD150/12IX	VELIS	74,00	63
AD146/32SB	COMPONENTI DOCCIA	184,00	357	AD150/12IX	COMPONENTI DOCCIA	74,00	369
AD146/32WM	COMPONENTI DOCCIA	172,00	357	AD150/12RCP	VELIS	79,00	63
AD146/35CR	COMPONENTI DOCCIA	116,00	356	AD150/12RCP	COMPONENTI DOCCIA	79,00	369
AD146/47BM	COMPONENTI DOCCIA	257,00	356	AD150/12RTP	VELIS	79,00	63
AD146/47CR	COMPONENTI DOCCIA	170,00	356	AD150/12RTP	COMPONENTI DOCCIA	79,00	369
AD146/47GUP	COMPONENTI DOCCIA	272,00	356	AD150/12SB	VELIS	79,00	63
AD146/48BM	COMPONENTI DOCCIA	213,00	358	AD150/12SB	COMPONENTI DOCCIA	79,00	369
AD146/48CR	COMPONENTI DOCCIA	142,00	358	AD150/12WM	COMPONENTI DOCCIA	74,00	369
AD146/48GUP	COMPONENTI DOCCIA	227,00	358	AD150/14CR	COMPONENTI DOCCIA	54,00	370
AD146/49BM	COMPONENTI DOCCIA	183,00	357	AD150/17BM	COMPONENTI DOCCIA	82,00	370
AD146/49CR	COMPONENTI DOCCIA	122,00	357	AD150/17CGP	COMPONENTI DOCCIA	86,00	370
AD146/51BM	AUSILI SANITARI	110,00	493	AD150/17CR	COMPONENTI DOCCIA	54,00	370
AD146/51CR	AUSILI SANITARI	57,00	493	AD150/17GUP	COMPONENTI DOCCIA	86,00	370
AD146/52BB	AUSILI SANITARI	36,00	493	AD150/17IX	COMPONENTI DOCCIA	82,00	370
AD146/52CR	AUSILI SANITARI	42,00	493	AD150/17RCP	COMPONENTI DOCCIA	86,00	370
AD146/53BM	COMPONENTI DOCCIA	216,00	358	AD150/17RTP	COMPONENTI DOCCIA	86,00	370
AD146/53CR	COMPONENTI DOCCIA	144,00	358	AD150/17SB	COMPONENTI DOCCIA	86,00	370
AD146/53IX	COMPONENTI DOCCIA	216,00	358	AD150/17WM	COMPONENTI DOCCIA	82,00	370
AD146/54CR	SOLE	270,00	40	AD150/18BM	COMPONENTI DOCCIA	106,00	370
AD146/54CR	COMPONENTI DOCCIA	270,00	356	AD150/18CR	COMPONENTI DOCCIA	69,00	370
AD146/54GUP	SOLE	432,00	40	AD150/18IX	COMPONENTI DOCCIA	106,00	370
AD146/54GUP	COMPONENTI DOCCIA	432,00	356	AD150/19BM	COMPONENTI DOCCIA	109,00	371
AD146/54IX	SOLE	405,00	40	AD150/19CR	COMPONENTI DOCCIA	72,00	371
AD146/54IX	COMPONENTI DOCCIA	405,00	356	AD150/19IX	COMPONENTI DOCCIA	109,00	371
AD146/54RTP	SOLE	432,00	40	AD150/82CR	COMPONENTI DOCCIA	64,00	371
AD146/54RTP	COMPONENTI DOCCIA	432,00	356	AD150CGP	COMPONENTI DOCCIA	37,00	370

CODICE	COLLEZIONE	EURO	PAG.	CODICE	COLLEZIONE	EURO	PAG.
AD150CR	COMPONENTI DOCCIA	23,00	370	AQ93300CR	CUCINA NOBILI	290,00	456
AD150SB	COMPONENTI DOCCIA	37,00	370	AQ93500CR	CUCINA SPECIALI	473,00	475
AESPO106001	SALA MOSTRA	1.178,00	533	AQ93500IX	CUCINA SPECIALI	710,00	475
AESPOFINISH	SALA MOSTRA	345,00	533	AQ93513CR	CUCINA SPECIALI	453,00	476
AQ109300/60CR	CUCINA NOBILI	610,00	456	AQ93513IX	CUCINA SPECIALI	679,00	476
AQ109300/60GTP	CUCINA NOBILI	976,00	456	AQ93660CR	ACQUERELLI	287,00	98
AQ109300/60GUP	CUCINA NOBILI	976,00	456	AQ93823/3VBMM	SORGENTE FILTRA	720,00	427
AQ109300/60IX	CUCINA NOBILI	793,00	456	AQ93823/3VBCR	SORGENTE FILTRA	610,00	427
AQ93100/EBM	ACQUERELLI	260,00	100	AQ93823/3VBGTP	SORGENTE FILTRA	810,00	427
AQ93100/EBM	EASYBOX	260,00	306	AQ93823/3VBGUP	SORGENTE FILTRA	810,00	427
AQ93100/ECR	ACQUERELLI	174,00	100	AQ93823/3VBRTTP	SORGENTE FILTRA	810,00	427
AQ93100/ECR	EASYBOX	174,00	306	AQ93823CR	CUCINA NOBILI	222,00	456
AQ93100/EIX	ACQUERELLI	260,00	100	AQ93824CR	CUCINA NOBILI	210,00	456
AQ93100/EIX	EASYBOX	260,00	306	AS35200/BCR	AUSILI SANITARI	102,00	488
AQ93108BM	ACQUERELLI	200,00	100	AS35300/BCR	AUSILI SANITARI	69,00	488
AQ93108CR	ACQUERELLI	132,00	100	AS35400/BCR	AUSILI SANITARI	69,00	488
AQ93108IX	ACQUERELLI	200,00	100	AS35500/VCR	AUSILI SANITARI	65,00	488
AQ93110BM	ACQUERELLI	473,00	99	AS35600CR	AUSILI SANITARI	128,00	489
AQ93110CR	ACQUERELLI	315,00	99	AS84118/1CCR	AUSILI SANITARI	184,00	485
AQ93110IX	ACQUERELLI	473,00	99	AS84118/2CCR	AUSILI SANITARI	172,00	485
AQ93113/1CR	CUCINA NOBILI	189,00	455	AS87118/1CCR	AUSILI SANITARI	177,00	485
AQ93113CR	CUCINA NOBILI	215,00	455	AS87118/2CCR	AUSILI SANITARI	167,00	485
AQ93114CR	CUCINA SPECIALI	314,00	476	AS97118/1CCR	AUSILI SANITARI	198,00	486
AQ93117CR	CUCINA NOBILI	215,00	455	AS97118/2CCR	AUSILI SANITARI	185,00	486
AQ93118/15BM	ACQUERELLI	249,00	97	ASRD115/CCR	AUSILI SANITARI	191,00	487
AQ93118/15CR	ACQUERELLI	166,00	97	ASRD118/1CCR	AUSILI SANITARI	198,00	486
AQ93118/15IX	ACQUERELLI	249,00	97	ASRD118/2CCR	AUSILI SANITARI	185,00	486
AQ93118/17BM	ACQUERELLI	244,00	97	ASRD123/1CCR	AUSILI SANITARI	148,00	487
AQ93118/17CR	ACQUERELLI	162,00	97	ASRD127/CCR	AUSILI SANITARI	210,00	487
AQ93118/17IX	ACQUERELLI	244,00	97	ASRD130/3CCR	AUSILI SANITARI	322,00	487
AQ93118/1BM	ACQUERELLI	238,00	97	AT18117CR	CUCINA NOBILI	248,00	460
AQ93118/1CR	ACQUERELLI	159,00	97	AT18117RTP	CUCINA NOBILI	397,00	460
AQ93118/1IX	ACQUERELLI	238,00	97	AT18117SB	CUCINA NOBILI	397,00	460
AQ93118/20BM	ACQUERELLI	264,00	98	AT18513/4CR	CUCINA SPECIALI	435,00	477
AQ93118/20CR	ACQUERELLI	176,00	98	AT18513/4RTP	CUCINA SPECIALI	696,00	477
AQ93118/20IX	ACQUERELLI	264,00	98	AT18513/4SB	CUCINA SPECIALI	696,00	477
AQ93118/2BM	ACQUERELLI	234,00	97	AT18513CR	CUCINA NOBILI	302,00	461
AQ93118/2CR	ACQUERELLI	155,00	97	AT18513RTP	CUCINA NOBILI	483,00	461
AQ93118/2IX	ACQUERELLI	234,00	97	AT18513SB	CUCINA NOBILI	483,00	461
AQ93118/30BM	ACQUERELLI	293,00	99	AT18517CR	CUCINA NOBILI	366,00	461
AQ93118/30CR	ACQUERELLI	195,00	99	AT18517RTP	CUCINA NOBILI	586,00	461
AQ93118/30IX	ACQUERELLI	293,00	99	AT18517SB	CUCINA NOBILI	586,00	461
AQ93119/1BM	ACQUERELLI	238,00	99	AT31003CR	CUCINA SPECIALI	255,00	479
AQ93119/1CR	ACQUERELLI	159,00	99	AT31003RTP	CUCINA SPECIALI	408,00	479
AQ93119/1IX	ACQUERELLI	238,00	99	AT31003SB	CUCINA SPECIALI	408,00	479
AQ93128/2BM	ACQUERELLI	423,00	98	AT31117CR	CUCINA NOBILI	242,00	460
AQ93128/2CR	ACQUERELLI	282,00	98	AT31117RTP	CUCINA NOBILI	387,00	460
AQ93128/2IX	ACQUERELLI	423,00	98	AT31117SB	CUCINA NOBILI	387,00	460
AQ93130/1BM	ACQUERELLI	353,00	99	AV00047	BORDO VASCA	141,00	520
AQ93130/1CR	ACQUERELLI	236,00	99	AV00100/10CR	COMPLEMENTI	64,00	496
AQ93130/1IX	ACQUERELLI	353,00	99	AV00100/50CR	COMPLEMENTI	60,00	496
AQ93130/30CR	COLONNE MONOCOMANDO	669,00	401	AV00101/51CR	COMPLEMENTI	145,00	496
AQ93130/50BM	COLONNE MONOCOMANDO	1.371,00	401	AV00102/3BM	COMPLEMENTI	349,00	497
AQ93130/50CR	COLONNE MONOCOMANDO	916,00	401	AV00102/3CR	COMPLEMENTI	232,00	497
AQ93130/50IX	COLONNE MONOCOMANDO	1.371,00	401	AV00102/3IX	COMPLEMENTI	349,00	497
AQ93236BM	ACQUERELLI	190,00	98	AV00103/2CR	COMPLEMENTI	30,00	497
AQ93236CR	ACQUERELLI	126,00	98	AV00105/2CR	COMPLEMENTI	30,00	497
AQ93236IX	ACQUERELLI	190,00	98	AV00107/10BM	COMPLEMENTI	309,00	496

CODICE	COLLEZIONE	EURO	PAG.	CODICE	COLLEZIONE	EURO	PAG.
AV00107/10CGP	COMPLEMENTI	330,00	496	AV00151/10CGP	GRAZIA	1.026,00	216
AV00107/10CR	COMPLEMENTI	206,00	496	AV00151/10CR	CARLOS PRIMERO	641,00	209
AV00107/10GUP	COMPLEMENTI	330,00	496	AV00151/10CR	GRAZIA	641,00	216
AV00107/10IX	COMPLEMENTI	309,00	496	AV00151/10SB	CARLOS PRIMERO	1.026,00	209
AV00107/10RCP	COMPLEMENTI	330,00	496	AV00151/11BM	LIRA	730,00	200
AV00107/10RTP	COMPLEMENTI	330,00	496	AV00151/11CR	LIRA	486,00	200
AV00107/10SB	COMPLEMENTI	330,00	496	AV00151/11GUP	LIRA	778,00	200
AV00107/10WM	COMPLEMENTI	309,00	496	AV00155/1CGP	COMPLEMENTI	35,00	504
AV00107/1CGP	COMPLEMENTI	69,00	497	AV00155/1CR	COMPLEMENTI	22,00	504
AV00107/1CR	COMPLEMENTI	43,00	497	AV00155/1SB	COMPLEMENTI	35,00	504
AV00107/1SB	COMPLEMENTI	69,00	497	AV00155/3CR	COMPLEMENTI	27,00	504
AV00109/3CR	COMPLEMENTI	16,00	499	AV00155/4BM	COMPLEMENTI	66,00	504
AV00110/11BM	COMPLEMENTI	95,00	495	AV00155/4CGP	COMPLEMENTI	71,00	504
AV00110/11CGP	COMPLEMENTI	101,00	495	AV00155/4CR	COMPLEMENTI	44,00	504
AV00110/11CR	COMPLEMENTI	63,00	495	AV00155/4GUP	COMPLEMENTI	71,00	504
AV00110/11GUP	COMPLEMENTI	101,00	495	AV00155/4IX	COMPLEMENTI	66,00	504
AV00110/11IX	COMPLEMENTI	95,00	495	AV00155/4RCP	COMPLEMENTI	71,00	504
AV00110/11RCP	COMPLEMENTI	101,00	495	AV00155/4RTP	COMPLEMENTI	71,00	504
AV00110/11RTP	COMPLEMENTI	101,00	495	AV00155/4SB	COMPLEMENTI	71,00	504
AV00110/11SB	COMPLEMENTI	101,00	495	AV00155/4WM	COMPLEMENTI	66,00	504
AV00110/11WM	COMPLEMENTI	95,00	495	AV00156/10BM	COMPONENTI DOCCIA	787,00	342
AV00110/2CR	COMPLEMENTI	22,00	495	AV00156/10CGP	COMPONENTI DOCCIA	840,00	342
AV00110/3BM	COMPLEMENTI	39,00	495	AV00156/10CR	COMPONENTI DOCCIA	525,00	342
AV00110/3CR	COMPLEMENTI	26,00	495	AV00156/10GUP	COMPONENTI DOCCIA	840,00	342
AV00111/10CR	COMPLEMENTI	24,00	498	AV00156/10IX	COMPONENTI DOCCIA	787,00	342
AV00111/11CR	COMPLEMENTI	26,00	498	AV00156/10RCP	COMPONENTI DOCCIA	840,00	342
AV00111/13CR	COMPLEMENTI	24,00	498	AV00156/10RTP	COMPONENTI DOCCIA	840,00	342
AV00111/13SB	COMPLEMENTI	38,00	498	AV00156/10SB	COMPONENTI DOCCIA	840,00	342
AV00111/1CR	COMPLEMENTI	39,00	499	AV00156/10WM	COMPONENTI DOCCIA	787,00	342
AV00111/20CR	COMPLEMENTI	27,00	498	AV00156/15BM	BORDO VASCA	212,00	515
AV00112CR	COMPLEMENTI	45,00	507	AV00156/15CR	BORDO VASCA	141,00	515
AV00113CR	COMPLEMENTI	85,00	507	AV00156/15WM	BORDO VASCA	212,00	515
AV00115/1CR	COMPLEMENTI	56,00	506	AV00156/16BM	BORDO VASCA	230,00	515
AV00115CR	COMPLEMENTI	51,00	506	AV00156/16CR	BORDO VASCA	154,00	515
AV00121/10CR	COMPLEMENTI	43,00	503	AV00156/16GUP	BORDO VASCA	246,00	515
AV00121/1CR	COMPLEMENTI	13,00	505	AV00156/17BM	BORDO VASCA	308,00	515
AV00121/21BM	COMPLEMENTI	95,00	502	AV00156/17CR	BORDO VASCA	205,00	515
AV00121/21CGP	COMPLEMENTI	101,00	502	AV00156/17GUP	BORDO VASCA	328,00	515
AV00121/21CR	COMPLEMENTI	63,00	502	AV00156/19CGP	BORDO VASCA	229,00	514
AV00121/21GUP	COMPLEMENTI	101,00	502	AV00156/19CR	BORDO VASCA	142,00	514
AV00121/21IX	COMPLEMENTI	95,00	502	AV00156/19GUP	BORDO VASCA	229,00	514
AV00121/21RCP	COMPLEMENTI	101,00	502	AV00156/19IX	BORDO VASCA	212,00	514
AV00121/21RTP	COMPLEMENTI	101,00	502	AV00156/19RCP	BORDO VASCA	229,00	514
AV00121/21SB	COMPLEMENTI	101,00	502	AV00156/19RTP	BORDO VASCA	229,00	514
AV00121/21WM	COMPLEMENTI	95,00	502	AV00156/19SB	BORDO VASCA	229,00	514
AV00121/22BM	COMPLEMENTI	114,00	502	AV00156/20CR	BORDO VASCA	224,00	514
AV00121/22CR	COMPLEMENTI	76,00	502	AV00156/20GUP	BORDO VASCA	358,00	514
AV00121/22IX	COMPLEMENTI	114,00	502	AV00156/20IX	BORDO VASCA	336,00	514
AV00121/2CGP	COMPLEMENTI	38,00	502	AV00156/20RTP	BORDO VASCA	358,00	514
AV00121/2CR	COMPLEMENTI	24,00	502	AV00156/20SB	BORDO VASCA	358,00	514
AV00121/2SB	COMPLEMENTI	38,00	502	AV00156/4CR	COMPLEMENTI	131,00	502
AV00121CR	COMPLEMENTI	13,00	503	AV00156/8BM	BORDO VASCA	1.454,00	516
AV00121SB	COMPLEMENTI	21,00	503	AV00156/8CR	BORDO VASCA	969,00	516
AV00123CR	COMPLEMENTI	13,00	505	AV00156/8IX	BORDO VASCA	1.454,00	516
AV00124CR	COMPLEMENTI	13,00	506	AV00156/9BM	COMPONENTI DOCCIA	787,00	342
AV00125CR	COMPLEMENTI	19,00	507	AV00156/9CGP	COMPONENTI DOCCIA	840,00	342
AV00141/5	COLONNE TERMOSTATICHE	36,00	398	AV00156/9CR	COMPONENTI DOCCIA	525,00	342
AV00151/10CGP	CARLOS PRIMERO	1.026,00	209	AV00156/9GUP	COMPONENTI DOCCIA	840,00	342



CODICE	COLLEZIONE	EURO	PAG.	CODICE	COLLEZIONE	EURO	PAG.
AV00156/9IX	COMPONENTI DOCCIA	787,00	342	AV00158/54DGUP	COMPLEMENTI	310,00	499
AV00156/9RCP	COMPONENTI DOCCIA	840,00	342	AV00158/54DIX	SOLE	291,00	34
AV00156/9RTP	COMPONENTI DOCCIA	840,00	342	AV00158/54DIX	COMPLEMENTI	291,00	499
AV00156/9SB	COMPONENTI DOCCIA	840,00	342	AV00158/54DRTP	SOLE	310,00	34
AV00156/9WM	COMPONENTI DOCCIA	787,00	342	AV00158/54DRTP	COMPLEMENTI	310,00	499
AV00156CR	BORDO VASCA	1.005,00	515	AV00158/54DSB	SOLE	310,00	34
AV00158/2CGP	BORDO VASCA	597,00	516	AV00158/54DSB	COMPLEMENTI	310,00	499
AV00158/2CR	BORDO VASCA	373,00	516	AV00158CR	COMPLEMENTI	75,00	501
AV00158/36BM	LIVE	155,00	89	AV00159/1CR	COMPLEMENTI	139,00	501
AV00158/36BM	COMPLEMENTI	155,00	499	AV00159/1RCP	COMPLEMENTI	223,00	501
AV00158/36CGP	VELIS	164,00	55	AV00159/2CR	COMPLEMENTI	139,00	501
AV00158/36CGP	LIVE	164,00	89	AV00159CR	COMPLEMENTI	57,00	500
AV00158/36CGP	COMPLEMENTI	164,00	499	AV00224/3CR	COMPLEMENTI	30,00	495
AV00158/36CR	VELIS	103,00	55	AV00300BM	COMPLEMENTI	518,00	503
AV00158/36CR	LIVE	103,00	89	AV00300CGP	COMPLEMENTI	552,00	503
AV00158/36CR	COMPLEMENTI	103,00	499	AV00300CR	COMPLEMENTI	345,00	503
AV00158/36GUP	VELIS	164,00	55	AV00300GUP	COMPLEMENTI	552,00	503
AV00158/36GUP	LIVE	164,00	89	AV00300IX	COMPLEMENTI	518,00	503
AV00158/36GUP	COMPLEMENTI	164,00	499	AV00300RCP	COMPLEMENTI	552,00	503
AV00158/36IX	VELIS	155,00	55	AV00300RTP	COMPLEMENTI	552,00	503
AV00158/36IX	LIVE	155,00	89	AV00300SB	COMPLEMENTI	552,00	503
AV00158/36IX	COMPLEMENTI	155,00	499	AV00405	SORGENTE BOLLE	109,00	433
AV00158/36RCP	VELIS	164,00	55	AV00405	SORGENTE FRIZZA	109,00	437
AV00158/36RCP	COMPLEMENTI	164,00	499	AV00405	SORGENTE FRIZZA & BOLLE	109,00	440
AV00158/36RTP	VELIS	164,00	55	AV00501CR	COMPLEMENTI	21,00	508
AV00158/36RTP	LIVE	164,00	89	AV00503CR	COMPLEMENTI	43,00	507
AV00158/36RTP	COMPLEMENTI	164,00	499	AV00505CR	COMPLEMENTI	27,00	508
AV00158/36SB	VELIS	164,00	55	AV00508CR	COMPLEMENTI	29,00	508
AV00158/36SB	COMPLEMENTI	164,00	499	AV00509CR	COMPLEMENTI	29,00	508
AV00158/36WM	LIVE	155,00	89	AV00600BM	AUSILI SANITARI	421,00	492
AV00158/36WM	COMPLEMENTI	155,00	499	AV00600CGP	AUSILI SANITARI	449,00	492
AV00158/38BM	MIA	269,00	180	AV00600CR	AUSILI SANITARI	281,00	492
AV00158/38BM	COMPLEMENTI	269,00	500	AV00600GUP	AUSILI SANITARI	449,00	492
AV00158/38CR	MIA	180,00	180	AV00600IX	AUSILI SANITARI	421,00	492
AV00158/38CR	COMPLEMENTI	180,00	500	AV00600RCP	AUSILI SANITARI	449,00	492
AV00158/38IX	MIA	269,00	180	AV00600RTP	AUSILI SANITARI	449,00	492
AV00158/38IX	COMPLEMENTI	269,00	500	AV00600SB	AUSILI SANITARI	449,00	492
AV00158/39CR	LOOP	172,00	148	AV00601BM	AUSILI SANITARI	270,00	492
AV00158/40BM	ACQUAVIVA	287,00	138	AV00601CGP	AUSILI SANITARI	288,00	492
AV00158/40BM	COMPLEMENTI	287,00	500	AV00601CR	AUSILI SANITARI	180,00	492
AV00158/40CR	ACQUAVIVA	191,00	138	AV00601GUP	AUSILI SANITARI	288,00	492
AV00158/40CR	COMPLEMENTI	191,00	500	AV00601IX	AUSILI SANITARI	270,00	492
AV00158/41CR	SOFI	182,00	190	AV00601RCP	AUSILI SANITARI	288,00	492
AV00158/41CR	COMPLEMENTI	182,00	500	AV00601RTP	AUSILI SANITARI	288,00	492
AV00158/41SB	SOFI	291,00	190	AV00601SB	AUSILI SANITARI	288,00	492
AV00158/41SB	COMPLEMENTI	291,00	500	AV00610CGP	AUSILI SANITARI	562,00	492
AV00158/52BM	COMPLEMENTI	300,00	501	AV00610CR	AUSILI SANITARI	351,00	492
AV00158/52CGP	COMPLEMENTI	320,00	501	AV00610SB	AUSILI SANITARI	562,00	492
AV00158/52CR	COMPLEMENTI	200,00	501	AV0K151/QCR	COMPLEMENTI	229,00	505
AV00158/52GUP	COMPLEMENTI	320,00	501	AV0K151BM	COMPLEMENTI	81,00	504
AV00158/52IX	COMPLEMENTI	300,00	501	AV0K151CR	COMPLEMENTI	54,00	504
AV00158/52RCP	COMPLEMENTI	320,00	501	AV0K151SB	COMPLEMENTI	86,00	504
AV00158/52RTP	COMPLEMENTI	320,00	501	AV30910CR	COMPLEMENTI	135,00	503
AV00158/52SB	COMPLEMENTI	320,00	501	AVANG/E	CANALINE DOCCIA	24,00	526
AV00158/52WM	COMPLEMENTI	300,00	501	AVANG/I	CANALINE DOCCIA	24,00	526
AV00158/54DCR	SOLE	194,00	34	AVCDA/07	CANALINE DOCCIA	507,00	523
AV00158/54DCR	COMPLEMENTI	194,00	499	AVCDA/08	CANALINE DOCCIA	546,00	523
AV00158/54DGUP	SOLE	310,00	34	AVCDA/09	CANALINE DOCCIA	580,00	523



CODICE	COLLEZIONE	EURO	PAG.	CODICE	COLLEZIONE	EURO	PAG.
AVCDA/10	CANALINE DOCCIA	618,00	523	BR00233IX	CUCINA NOBILI	355,00	453
AVCDA/12	CANALINE DOCCIA	689,00	523	BR00237BM	CUCINA NOBILI	425,00	453
AVCDB/07	CANALINE DOCCIA	507,00	523	BR00237CR	CUCINA NOBILI	314,00	453
AVCDB/08	CANALINE DOCCIA	546,00	523	BR00237IX	CUCINA NOBILI	472,00	453
AVCDB/09	CANALINE DOCCIA	580,00	523	BR00300BM	CUCINA NOBILI	472,00	454
AVCDB/10	CANALINE DOCCIA	618,00	523	BR00300CR	CUCINA NOBILI	350,00	454
AVCDB/12	CANALINE DOCCIA	689,00	523	BS101100CR	BLUES	138,00	226
AVCDR01	CANALINE DOCCIA	41,00	525	BS101108CR	BLUES	62,00	226
AVGR01/07CR	CANALINE DOCCIA	181,00	523	BS101110/1CR	BLUES	129,00	225
AVGR01/08CR	CANALINE DOCCIA	191,00	523	BS101110CR	BLUES	154,00	225
AVGR01/09CR	CANALINE DOCCIA	205,00	523	BS101113/60CR	CUCINA ENNE	93,00	470
AVGR01/10CR	CANALINE DOCCIA	215,00	523	BS101113CR	CUCINA ENNE	103,00	471
AVGR01/12CR	CANALINE DOCCIA	240,00	523	BS101115CR	CUCINA SPECIALI	151,00	479
AVGR02/07CR	CANALINE DOCCIA	181,00	523	BS101117CR	CUCINA ENNE	181,00	470
AVGR02/08CR	CANALINE DOCCIA	191,00	523	BS101118/10CR	BLUES	166,00	225
AVGR02/09CR	CANALINE DOCCIA	205,00	523	BS101118/1CR	BLUES	84,00	223
AVGR02/10CR	CANALINE DOCCIA	215,00	523	BS101118/3CR	BLUES	81,00	224
AVGR02/12CR	CANALINE DOCCIA	240,00	523	BS101119/1CR	BLUES	84,00	225
AVGR03/07CR	CANALINE DOCCIA	181,00	524	BS101127CR	CUCINA ENNE	175,00	470
AVGR03/08CR	CANALINE DOCCIA	191,00	524	BS101130/30CR	COLONNE MONOCOMANDO	588,00	405
AVGR03/09CR	CANALINE DOCCIA	205,00	524	BS101130/60CR	COLONNE MONOCOMANDO	489,00	405
AVGR03/10CR	CANALINE DOCCIA	215,00	524	BS101130CR	BLUES	103,00	226
AVGR03/12CR	CANALINE DOCCIA	240,00	524	BS101338/2CR	BLUES	292,00	224
AVGR04/07CR	CANALINE DOCCIA	181,00	524	BSE101113/25CR	CUCINA ENNE	134,00	470
AVGR04/08CR	CANALINE DOCCIA	191,00	524	BSH101118/1CR	BLUES	84,00	223
AVGR04/09CR	CANALINE DOCCIA	205,00	524	BSH101118/3CR	BLUES	81,00	223
AVGR04/10CR	CANALINE DOCCIA	215,00	524	BSH101118/4CR	BLUES	84,00	223
AVGR04/12CR	CANALINE DOCCIA	240,00	524	BSH101119/1CR	BLUES	84,00	224
AVGR05/07CR	CANALINE DOCCIA	181,00	524	BSH101119/4CR	BLUES	84,00	224
AVGR05/08CR	CANALINE DOCCIA	191,00	524	CH75500CR	CUCINA NOBILI	539,00	459
AVGR05/09CR	CANALINE DOCCIA	205,00	524	CH75500RTP	CUCINA NOBILI	862,00	459
AVGR05/10CR	CANALINE DOCCIA	215,00	524	CH75500SB	CUCINA NOBILI	862,00	459
AVGR05/12CR	CANALINE DOCCIA	240,00	524	CH75513CR	CUCINA NOBILI	334,00	458
AVGR06/07CR	CANALINE DOCCIA	181,00	524	CH75513RTP	CUCINA NOBILI	534,00	458
AVGR06/08CR	CANALINE DOCCIA	191,00	524	CH75513SB	CUCINA NOBILI	534,00	458
AVGR06/09CR	CANALINE DOCCIA	205,00	524	CP030/50CGP	COLONNE TERMOSTATICHE	2.109,00	393
AVGR06/10CR	CANALINE DOCCIA	215,00	524	CP030/50CR	COLONNE TERMOSTATICHE	1.318,00	393
AVGR06/12CR	CANALINE DOCCIA	240,00	524	CP030/50SB	COLONNE TERMOSTATICHE	2.109,00	393
AVGUA/07	CANALINE DOCCIA	27,00	525	CP101CGP	CARLOS PRIMERO	707,00	210
AVGUA/08	CANALINE DOCCIA	30,00	525	CP101CGP	WELLBOX	707,00	321
AVGUA/09	CANALINE DOCCIA	42,00	525	CP101CR	CARLOS PRIMERO	442,00	210
AVGUA/10	CANALINE DOCCIA	42,00	525	CP101CR	WELLBOX	442,00	321
AVGUA/100	CANALINE DOCCIA	332,00	525	CP101SB	CARLOS PRIMERO	707,00	210
AVGUA/12	CANALINE DOCCIA	45,00	525	CP101SB	WELLBOX	707,00	321
AVGUA/300	CANALINE DOCCIA	956,00	525	CP102CGP	CARLOS PRIMERO	707,00	211
AVNAS/3	CANALINE DOCCIA	17,00	526	CP102CGP	WELLBOX	707,00	325
AVP3534BM	DISPENSER SAPONE	180,00	481	CP102CR	CARLOS PRIMERO	442,00	211
AVP3534CR	DISPENSER SAPONE	120,00	481	CP102CR	WELLBOX	442,00	325
AVP3534GTP	DISPENSER SAPONE	192,00	481	CP102SB	CARLOS PRIMERO	707,00	211
AVP3534GUP	DISPENSER SAPONE	192,00	481	CP102SB	WELLBOX	707,00	325
AVP3534IX	DISPENSER SAPONE	180,00	481	CP103CGP	CARLOS PRIMERO	1.414,00	211
AVP3534RTP	DISPENSER SAPONE	192,00	481	CP103CGP	WELLBOX	1.414,00	329
AVP3536CR	DISPENSER SAPONE	147,00	481	CP103CR	CARLOS PRIMERO	884,00	211
AVROG/100	CANALINE DOCCIA	6,00	525	CP103CR	WELLBOX	884,00	329
BPLV113CR	CUCINA SPECIALI	332,00	478	CP103SB	CARLOS PRIMERO	1.414,00	211
BPLV117/1CR	CUCINA SPECIALI	365,00	478	CP103SB	WELLBOX	1.414,00	329
BR00233BM	CUCINA NOBILI	320,00	453	CP104CGP	CARLOS PRIMERO	1.414,00	212
BR00233CR	CUCINA NOBILI	237,00	453	CP104CGP	WELLBOX	1.414,00	333

CODICE	COLLEZIONE	EURO	PAG.	CODICE	COLLEZIONE	EURO	PAG.
CP104CR	CARLOS PRIMERO	884,00	212	CU128137BM	CUCINA NOBILI	439,00	446
CP104CR	WELLBOX	884,00	333	CU128137CR	CUCINA NOBILI	318,00	446
CP104SB	CARLOS PRIMERO	1.414,00	212	CU128137GTP	CUCINA NOBILI	509,00	446
CP104SB	WELLBOX	1.414,00	333	CU128137GUP	CUCINA NOBILI	509,00	446
CP160CGP	CARLOS PRIMERO	413,00	210	CU128137RTP	CUCINA NOBILI	509,00	446
CP160CR	CARLOS PRIMERO	258,00	210	CU92813CR	CUCINA ENNE	88,00	468
CP160SB	CARLOS PRIMERO	413,00	210	CU96113CR	CUCINA NOBILI	207,00	451
CP210CGP	CARLOS PRIMERO	840,00	209	CU96113GTP	CUCINA NOBILI	332,00	451
CP210CR	CARLOS PRIMERO	525,00	209	CU96113GUP	CUCINA NOBILI	332,00	451
CP210SB	CARLOS PRIMERO	840,00	209	CU96113RTP	CUCINA NOBILI	332,00	451
CP211/1CGP	CARLOS PRIMERO	611,00	207	CU96123CR	CUCINA NOBILI	207,00	451
CP211/1CR	CARLOS PRIMERO	382,00	207	CU96123GTP	CUCINA NOBILI	332,00	451
CP211/1SB	CARLOS PRIMERO	611,00	207	CU96123GUP	CUCINA NOBILI	332,00	451
CP212/1CGP	CARLOS PRIMERO	717,00	207	CU96123RTP	CUCINA NOBILI	332,00	451
CP212/1CR	CARLOS PRIMERO	448,00	207	CU96600CR	CUCINA SPECIALI	361,00	475
CP212/1SB	CARLOS PRIMERO	717,00	207	DS106030/51C01	COLONNE TERMOSTATICHE	1.447,00	392
CP215/1CGP	CARLOS PRIMERO	717,00	208	DS106030/51C02	COLONNE TERMOSTATICHE	1.447,00	392
CP215/1CR	CARLOS PRIMERO	448,00	208	DS106030/51C07	COLONNE TERMOSTATICHE	1.447,00	392
CP215/1SB	CARLOS PRIMERO	717,00	208	DS106030/51C08	COLONNE TERMOSTATICHE	1.447,00	392
CP217CR	CUCINA NOBILI	281,00	459	DS106030/51C09	COLONNE TERMOSTATICHE	1.565,00	392
CP218/1CGP	CARLOS PRIMERO	488,00	207	DS106030/51C10	COLONNE TERMOSTATICHE	1.565,00	392
CP218/1CR	CARLOS PRIMERO	305,00	207	DS106030/51C11	COLONNE TERMOSTATICHE	1.565,00	392
CP218/1SB	CARLOS PRIMERO	488,00	207	DS106030/51C12	COLONNE TERMOSTATICHE	1.565,00	392
CP219/1CGP	CARLOS PRIMERO	488,00	208	DS106030/51C14	COLONNE TERMOSTATICHE	1.685,00	392
CP219/1CR	CARLOS PRIMERO	305,00	208	DS106030/51C16	COLONNE TERMOSTATICHE	1.685,00	392
CP219/1SB	CARLOS PRIMERO	488,00	208	DS106030/51C17	COLONNE TERMOSTATICHE	2.244,00	392
CP230CGP	CARLOS PRIMERO	456,00	209	DS106030/51C19	COLONNE TERMOSTATICHE	2.244,00	392
CP230CR	CARLOS PRIMERO	285,00	209	DS106030/51C21	COLONNE TERMOSTATICHE	1.965,00	392
CP230SB	CARLOS PRIMERO	456,00	209	DS106030/51T22	COLONNE TERMOSTATICHE	1.965,00	392
CP298/ECGP	CARLOS PRIMERO	509,00	208	DS106030/51TBK	COLONNE TERMOSTATICHE	1.685,00	392
CP298/ECGP	ALLBOX	509,00	303	DS106030/51TNI	COLONNE TERMOSTATICHE	1.685,00	392
CP298/ECR	CARLOS PRIMERO	318,00	208	DS106030C01	DRESS	415,00	68
CP298/ECR	ALLBOX	318,00	303	DS106030C01	TERMOSTATICI ESTERNI	415,00	377
CP298/ESB	CARLOS PRIMERO	509,00	208	DS106030C02	DRESS	415,00	68
CP298/ESB	ALLBOX	509,00	303	DS106030C02	TERMOSTATICI ESTERNI	415,00	377
CPK208/1CGP	CARLOS PRIMERO	525,00	210	DS106030C07	DRESS	415,00	68
CPK208/1CR	CARLOS PRIMERO	328,00	210	DS106030C07	TERMOSTATICI ESTERNI	415,00	377
CPK208/1SB	CARLOS PRIMERO	525,00	210	DS106030C08	DRESS	415,00	68
CU128113BM	CUCINA NOBILI	358,00	445	DS106030C08	TERMOSTATICI ESTERNI	415,00	377
CU128113CR	CUCINA NOBILI	265,00	445	DS106030C09	DRESS	538,00	68
CU128113GTP	CUCINA NOBILI	424,00	445	DS106030C09	TERMOSTATICI ESTERNI	538,00	377
CU128113GUP	CUCINA NOBILI	424,00	445	DS106030C10	DRESS	538,00	68
CU128113RTP	CUCINA NOBILI	424,00	445	DS106030C10	TERMOSTATICI ESTERNI	538,00	377
CU128117/1BM	CUCINA NOBILI	414,00	445	DS106030C11	DRESS	538,00	68
CU128117/1CR	CUCINA NOBILI	306,00	445	DS106030C11	TERMOSTATICI ESTERNI	538,00	377
CU128117/1GTP	CUCINA NOBILI	490,00	445	DS106030C12	DRESS	538,00	68
CU128117/1GUP	CUCINA NOBILI	490,00	445	DS106030C12	TERMOSTATICI ESTERNI	538,00	377
CU128117/1RTP	CUCINA NOBILI	490,00	445	DS106030C14	DRESS	664,00	68
CU128123BM	CUCINA NOBILI	330,00	445	DS106030C14	TERMOSTATICI ESTERNI	664,00	377
CU128123CR	CUCINA NOBILI	245,00	445	DS106030C16	DRESS	664,00	68
CU128123GTP	CUCINA NOBILI	392,00	445	DS106030C16	TERMOSTATICI ESTERNI	664,00	377
CU128123GUP	CUCINA NOBILI	392,00	445	DS106030C17	DRESS	1.244,00	68
CU128123RTP	CUCINA NOBILI	392,00	445	DS106030C17	TERMOSTATICI ESTERNI	1.244,00	377
CU128133BM	CUCINA NOBILI	330,00	445	DS106030C19	DRESS	1.244,00	68
CU128133CR	CUCINA NOBILI	245,00	445	DS106030C19	TERMOSTATICI ESTERNI	1.244,00	377
CU128133GTP	CUCINA NOBILI	392,00	445	DS106030C21	DRESS	1.054,00	68
CU128133GUP	CUCINA NOBILI	392,00	445	DS106030C21	TERMOSTATICI ESTERNI	1.054,00	377
CU128133RTP	CUCINA NOBILI	392,00	445	DS106030T22	DRESS	1.054,00	68

CODICE	COLLEZIONE	EURO	PAG.	CODICE	COLLEZIONE	EURO	PAG.
DS106030T22	TERMOSTATICI ESTERNI	1.054,00	377	DS106101C17	WELLBOX	1.323,00	319
DS106030TBK	DRESS	664,00	68	DS106101C19	DRESS	1.323,00	70
DS106030TBK	TERMOSTATICI ESTERNI	664,00	377	DS106101C19	WELLBOX	1.323,00	319
DS106030TNI	DRESS	664,00	68	DS106101C21	DRESS	1.180,00	70
DS106030TNI	TERMOSTATICI ESTERNI	664,00	377	DS106101C21	WELLBOX	1.180,00	319
DS106100/EC01	DRESS	295,00	68	DS106101T22	DRESS	1.180,00	70
DS106100/EC01	EASYBOX	295,00	305	DS106101T22	WELLBOX	1.180,00	319
DS106100/EC02	DRESS	295,00	68	DS106101TBK	DRESS	837,00	70
DS106100/EC02	EASYBOX	295,00	305	DS106101TBK	WELLBOX	837,00	319
DS106100/EC07	DRESS	295,00	68	DS106101TNI	DRESS	837,00	70
DS106100/EC07	EASYBOX	295,00	305	DS106101TNI	WELLBOX	837,00	319
DS106100/EC08	DRESS	295,00	68	DS106102C01	DRESS	629,00	70
DS106100/EC08	EASYBOX	295,00	305	DS106102C01	WELLBOX	629,00	323
DS106100/EC09	DRESS	403,00	68	DS106102C02	DRESS	629,00	70
DS106100/EC09	EASYBOX	403,00	305	DS106102C02	WELLBOX	629,00	323
DS106100/EC10	DRESS	403,00	68	DS106102C07	DRESS	629,00	70
DS106100/EC10	EASYBOX	403,00	305	DS106102C07	WELLBOX	629,00	323
DS106100/EC11	DRESS	403,00	68	DS106102C08	DRESS	629,00	70
DS106100/EC11	EASYBOX	403,00	305	DS106102C08	WELLBOX	629,00	323
DS106100/EC12	DRESS	403,00	68	DS106102C09	DRESS	732,00	70
DS106100/EC12	EASYBOX	403,00	305	DS106102C09	WELLBOX	732,00	323
DS106100/EC14	DRESS	512,00	68	DS106102C10	DRESS	732,00	70
DS106100/EC14	EASYBOX	512,00	305	DS106102C10	WELLBOX	732,00	323
DS106100/EC16	DRESS	512,00	68	DS106102C11	DRESS	732,00	70
DS106100/EC16	EASYBOX	512,00	305	DS106102C11	WELLBOX	732,00	323
DS106100/EC17	DRESS	1.020,00	68	DS106102C12	DRESS	732,00	70
DS106100/EC17	EASYBOX	1.020,00	305	DS106102C12	WELLBOX	732,00	323
DS106100/EC19	DRESS	1.020,00	68	DS106102C14	DRESS	837,00	70
DS106100/EC19	EASYBOX	1.020,00	305	DS106102C14	WELLBOX	837,00	323
DS106100/EC21	DRESS	868,00	68	DS106102C16	DRESS	837,00	70
DS106100/EC21	EASYBOX	868,00	305	DS106102C16	WELLBOX	837,00	323
DS106100/ET22	DRESS	868,00	68	DS106102C17	DRESS	1.323,00	70
DS106100/ET22	EASYBOX	868,00	305	DS106102C17	WELLBOX	1.323,00	323
DS106100/ETBK	DRESS	512,00	68	DS106102C19	DRESS	1.323,00	70
DS106100/ETBK	EASYBOX	512,00	305	DS106102C19	WELLBOX	1.323,00	323
DS106100/ETNI	DRESS	512,00	68	DS106102C21	DRESS	1.180,00	70
DS106100/ETNI	EASYBOX	512,00	305	DS106102C21	WELLBOX	1.180,00	323
DS106101C01	DRESS	629,00	70	DS106102T22	DRESS	1.180,00	70
DS106101C01	WELLBOX	629,00	319	DS106102T22	WELLBOX	1.180,00	323
DS106101C02	DRESS	629,00	70	DS106102TBK	DRESS	837,00	70
DS106101C02	WELLBOX	629,00	319	DS106102TBK	WELLBOX	837,00	323
DS106101C07	DRESS	629,00	70	DS106102TNI	DRESS	837,00	70
DS106101C07	WELLBOX	629,00	319	DS106102TNI	WELLBOX	837,00	323
DS106101C08	DRESS	629,00	70	DS106103C01	DRESS	993,00	71
DS106101C08	WELLBOX	629,00	319	DS106103C01	WELLBOX	993,00	327
DS106101C09	DRESS	732,00	70	DS106103C02	DRESS	993,00	71
DS106101C09	WELLBOX	732,00	319	DS106103C02	WELLBOX	993,00	327
DS106101C10	DRESS	732,00	70	DS106103C07	DRESS	993,00	71
DS106101C10	WELLBOX	732,00	319	DS106103C07	WELLBOX	993,00	327
DS106101C11	DRESS	732,00	70	DS106103C08	DRESS	993,00	71
DS106101C11	WELLBOX	732,00	319	DS106103C08	WELLBOX	993,00	327
DS106101C12	DRESS	732,00	70	DS106103C09	DRESS	1.240,00	71
DS106101C12	WELLBOX	732,00	319	DS106103C09	WELLBOX	1.240,00	327
DS106101C14	DRESS	837,00	70	DS106103C10	DRESS	1.240,00	71
DS106101C14	WELLBOX	837,00	319	DS106103C10	WELLBOX	1.240,00	327
DS106101C16	DRESS	837,00	70	DS106103C11	DRESS	1.240,00	71
DS106101C16	WELLBOX	837,00	319	DS106103C11	WELLBOX	1.240,00	327
DS106101C17	DRESS	1.323,00	70	DS106103C12	DRESS	1.240,00	71

CODICE	COLLEZIONE	EURO	PAG.	CODICE	COLLEZIONE	EURO	PAG.
DS106103C12	WELLBOX	1.240,00	327	DS106108C16	DRESS	580,00	68
DS106103C14	DRESS	1.490,00	71	DS106108C17	DRESS	1.088,00	68
DS106103C14	WELLBOX	1.490,00	327	DS106108C19	DRESS	1.088,00	68
DS106103C16	DRESS	1.490,00	71	DS106108C21	DRESS	935,00	68
DS106103C16	WELLBOX	1.490,00	327	DS106108T22	DRESS	935,00	68
DS106103C17	DRESS	2.652,00	71	DS106108TBK	DRESS	580,00	68
DS106103C17	WELLBOX	2.652,00	327	DS106108TNI	DRESS	580,00	68
DS106103C19	DRESS	2.652,00	71	DS106110/1C01	DRESS	781,00	67
DS106103C19	WELLBOX	2.652,00	327	DS106110/1C02	DRESS	781,00	67
DS106103C21	DRESS	2.171,00	71	DS106110/1C07	DRESS	781,00	67
DS106103C21	WELLBOX	2.171,00	327	DS106110/1C08	DRESS	781,00	67
DS106103T22	DRESS	2.171,00	71	DS106110/1C09	DRESS	1.023,00	67
DS106103T22	WELLBOX	2.171,00	327	DS106110/1C10	DRESS	1.023,00	67
DS106103TBK	DRESS	1.490,00	71	DS106110/1C11	DRESS	1.023,00	67
DS106103TBK	WELLBOX	1.490,00	327	DS106110/1C12	DRESS	1.023,00	67
DS106103TNI	DRESS	1.490,00	71	DS106110/1C14	DRESS	1.264,00	67
DS106103TNI	WELLBOX	1.490,00	327	DS106110/1C16	DRESS	1.264,00	67
DS106104C01	DRESS	993,00	71	DS106110/1C17	DRESS	2.389,00	67
DS106104C01	WELLBOX	993,00	331	DS106110/1C19	DRESS	2.389,00	67
DS106104C02	DRESS	993,00	71	DS106110/1C21	DRESS	1.927,00	67
DS106104C02	WELLBOX	993,00	331	DS106110/1T22	DRESS	1.927,00	67
DS106104C07	DRESS	993,00	71	DS106110/1TBK	DRESS	1.264,00	67
DS106104C07	WELLBOX	993,00	331	DS106110/1TNI	DRESS	1.264,00	67
DS106104C08	DRESS	993,00	71	DS106110C01	DRESS	873,00	67
DS106104C08	WELLBOX	993,00	331	DS106110C02	DRESS	873,00	67
DS106104C09	DRESS	1.240,00	71	DS106110C07	DRESS	873,00	67
DS106104C09	WELLBOX	1.240,00	331	DS106110C08	DRESS	873,00	67
DS106104C10	DRESS	1.240,00	71	DS106110C09	DRESS	1.111,00	67
DS106104C10	WELLBOX	1.240,00	331	DS106110C10	DRESS	1.111,00	67
DS106104C11	DRESS	1.240,00	71	DS106110C11	DRESS	1.111,00	67
DS106104C11	WELLBOX	1.240,00	331	DS106110C12	DRESS	1.111,00	67
DS106104C12	DRESS	1.240,00	71	DS106110C14	DRESS	1.352,00	67
DS106104C12	WELLBOX	1.240,00	331	DS106110C16	DRESS	1.352,00	67
DS106104C14	DRESS	1.490,00	71	DS106110C17	DRESS	2.478,00	67
DS106104C14	WELLBOX	1.490,00	331	DS106110C19	DRESS	2.478,00	67
DS106104C16	DRESS	1.490,00	71	DS106110C21	DRESS	2.017,00	67
DS106104C16	WELLBOX	1.490,00	331	DS106110T22	DRESS	2.017,00	67
DS106104C17	DRESS	2.652,00	71	DS106110TBK	DRESS	1.352,00	67
DS106104C17	WELLBOX	2.652,00	331	DS106110TNI	DRESS	1.352,00	67
DS106104C19	DRESS	2.652,00	71	DS106118/1C01	DRESS	484,00	65
DS106104C19	WELLBOX	2.652,00	331	DS106118/1C02	DRESS	484,00	65
DS106104C21	DRESS	2.171,00	71	DS106118/1C07	DRESS	484,00	65
DS106104C21	WELLBOX	2.171,00	331	DS106118/1C08	DRESS	484,00	65
DS106104T22	DRESS	2.171,00	71	DS106118/1C09	DRESS	627,00	65
DS106104T22	WELLBOX	2.171,00	331	DS106118/1C10	DRESS	627,00	65
DS106104TBK	DRESS	1.490,00	71	DS106118/1C11	DRESS	627,00	65
DS106104TBK	WELLBOX	1.490,00	331	DS106118/1C12	DRESS	627,00	65
DS106104TNI	DRESS	1.490,00	71	DS106118/1C14	DRESS	773,00	65
DS106104TNI	WELLBOX	1.490,00	331	DS106118/1C16	DRESS	773,00	65
DS106108C01	DRESS	364,00	68	DS106118/1C17	DRESS	1.449,00	65
DS106108C02	DRESS	364,00	68	DS106118/1C19	DRESS	1.449,00	65
DS106108C07	DRESS	364,00	68	DS106118/1C21	DRESS	1.210,00	65
DS106108C08	DRESS	364,00	68	DS106118/1T22	DRESS	1.210,00	65
DS106108C09	DRESS	470,00	68	DS106118/1TBK	DRESS	773,00	65
DS106108C10	DRESS	470,00	68	DS106118/1TNI	DRESS	773,00	65
DS106108C11	DRESS	470,00	68	DS106118/2C01	DRESS	498,00	65
DS106108C12	DRESS	470,00	68	DS106118/2C02	DRESS	498,00	65
DS106108C14	DRESS	580,00	68	DS106118/2C07	DRESS	498,00	65

CODICE	COLLEZIONE	EURO	PAG.	CODICE	COLLEZIONE	EURO	PAG.
DS106118/2C08	DRESS	498,00	65	DS106158/2T22	DRESS	1.409,00	65
DS106118/2C09	DRESS	641,00	65	DS106158/2TBK	DRESS	917,00	65
DS106118/2C10	DRESS	641,00	65	DS106158/2TNI	DRESS	917,00	65
DS106118/2C11	DRESS	641,00	65	DS106198/1C01	DRESS	591,00	66
DS106118/2C12	DRESS	641,00	65	DS106198/1C01	ALLBOX	591,00	289
DS106118/2C14	DRESS	786,00	65	DS106198/1C02	DRESS	591,00	66
DS106118/2C16	DRESS	786,00	65	DS106198/1C02	ALLBOX	591,00	289
DS106118/2C17	DRESS	1.462,00	65	DS106198/1C07	DRESS	591,00	66
DS106118/2C19	DRESS	1.462,00	65	DS106198/1C07	ALLBOX	591,00	289
DS106118/2C21	DRESS	1.224,00	65	DS106198/1C08	DRESS	591,00	66
DS106118/2T22	DRESS	1.224,00	65	DS106198/1C08	ALLBOX	591,00	289
DS106118/2TBK	DRESS	786,00	65	DS106198/1C09	DRESS	758,00	66
DS106118/2TNI	DRESS	786,00	65	DS106198/1C09	ALLBOX	758,00	289
DS106119/1C01	DRESS	484,00	67	DS106198/1C10	DRESS	758,00	66
DS106119/1C02	DRESS	484,00	67	DS106198/1C10	ALLBOX	758,00	289
DS106119/1C07	DRESS	484,00	67	DS106198/1C11	DRESS	758,00	66
DS106119/1C08	DRESS	484,00	67	DS106198/1C11	ALLBOX	758,00	289
DS106119/1C09	DRESS	627,00	67	DS106198/1C12	DRESS	758,00	66
DS106119/1C10	DRESS	627,00	67	DS106198/1C12	ALLBOX	758,00	289
DS106119/1C11	DRESS	627,00	67	DS106198/1C14	DRESS	928,00	66
DS106119/1C12	DRESS	627,00	67	DS106198/1C14	ALLBOX	928,00	289
DS106119/1C14	DRESS	773,00	67	DS106198/1C16	DRESS	928,00	66
DS106119/1C16	DRESS	773,00	67	DS106198/1C16	ALLBOX	928,00	289
DS106119/1C17	DRESS	1.449,00	67	DS106198/1C17	DRESS	1.716,00	66
DS106119/1C19	DRESS	1.449,00	67	DS106198/1C17	ALLBOX	1.716,00	289
DS106119/1C21	DRESS	1.210,00	67	DS106198/1C19	DRESS	1.716,00	66
DS106119/1T22	DRESS	1.210,00	67	DS106198/1C19	ALLBOX	1.716,00	289
DS106119/1TBK	DRESS	773,00	67	DS106198/1C21	DRESS	1.423,00	66
DS106119/1TNI	DRESS	773,00	67	DS106198/1C21	ALLBOX	1.423,00	289
DS106128/2C01	DRESS	665,00	65	DS106198/1T22	DRESS	1.423,00	66
DS106128/2C02	DRESS	665,00	65	DS106198/1T22	ALLBOX	1.423,00	289
DS106128/2C07	DRESS	665,00	65	DS106198/1TBK	DRESS	928,00	66
DS106128/2C08	DRESS	665,00	65	DS106198/1TBK	ALLBOX	928,00	289
DS106128/2C09	DRESS	833,00	65	DS106198/1TNI	DRESS	928,00	66
DS106128/2C10	DRESS	833,00	65	DS106198/1TNI	ALLBOX	928,00	289
DS106128/2C11	DRESS	833,00	65	DS106198C01	DRESS	564,00	66
DS106128/2C12	DRESS	833,00	65	DS106198C01	ALLBOX	564,00	289
DS106128/2C14	DRESS	1.001,00	65	DS106198C02	DRESS	564,00	66
DS106128/2C16	DRESS	1.001,00	65	DS106198C02	ALLBOX	564,00	289
DS106128/2C17	DRESS	1.789,00	65	DS106198C07	DRESS	564,00	66
DS106128/2C19	DRESS	1.789,00	65	DS106198C07	ALLBOX	564,00	289
DS106128/2C21	DRESS	1.495,00	65	DS106198C08	DRESS	564,00	66
DS106128/2T22	DRESS	1.495,00	65	DS106198C08	ALLBOX	564,00	289
DS106128/2TBK	DRESS	1.001,00	65	DS106198C09	DRESS	732,00	66
DS106128/2TNI	DRESS	1.001,00	65	DS106198C09	ALLBOX	732,00	289
DS106158/2C01	DRESS	578,00	65	DS106198C10	DRESS	732,00	66
DS106158/2C02	DRESS	578,00	65	DS106198C10	ALLBOX	732,00	289
DS106158/2C07	DRESS	578,00	65	DS106198C11	DRESS	732,00	66
DS106158/2C08	DRESS	578,00	65	DS106198C11	ALLBOX	732,00	289
DS106158/2C09	DRESS	746,00	65	DS106198C12	DRESS	732,00	66
DS106158/2C10	DRESS	746,00	65	DS106198C12	ALLBOX	732,00	289
DS106158/2C11	DRESS	746,00	65	DS106198C14	DRESS	902,00	66
DS106158/2C12	DRESS	746,00	65	DS106198C14	ALLBOX	902,00	289
DS106158/2C14	DRESS	917,00	65	DS106198C16	DRESS	902,00	66
DS106158/2C16	DRESS	917,00	65	DS106198C16	ALLBOX	902,00	289
DS106158/2C17	DRESS	1.703,00	65	DS106198C17	DRESS	1.689,00	66
DS106158/2C19	DRESS	1.703,00	65	DS106198C17	ALLBOX	1.689,00	289
DS106158/2C21	DRESS	1.409,00	65	DS106198C19	DRESS	1.689,00	66

CODICE	COLLEZIONE	EURO	PAG.	CODICE	COLLEZIONE	EURO	PAG.
DSI06198C19	ALLBOX	1.689,00	289	GRC5001CGP	GRAZIA	619,00	216
DSI06198C21	DRESS	1.396,00	66	GRC5001CGP	GRAZIA	619,00	217
DSI06198C21	ALLBOX	1.396,00	289	GRC5001CR	GRAZIA	387,00	216
DSI06198T22	DRESS	1.396,00	66	GRC5001CR	GRAZIA	387,00	217
DSI06198T22	ALLBOX	1.396,00	289	GRC5003/1CGP	GRAZIA	291,00	218
DSI06198TBK	DRESS	902,00	66	GRC5003/1CR	GRAZIA	182,00	218
DSI06198TBK	ALLBOX	902,00	289	GRC5003CR	CUCINA SPECIALI	190,00	479
DSI06198TNI	DRESS	902,00	66	GRC5004/2CGP	GRAZIA	112,00	215
DSI06198TNI	ALLBOX	902,00	289	GRC5004/2CR	GRAZIA	70,00	215
ESP233/11NOB	SALA MOSTRA	675,00	529	GRC5008/1CGP	GRAZIA	131,00	218
ESP233/12NOB	SALA MOSTRA	546,00	529	GRC5008/1CR	GRAZIA	82,00	218
ESP233/14	SALA MOSTRA	558,00	532	GRC5011/1CGP	GRAZIA	437,00	215
ESP233/14C	SALA MOSTRA	293,00	532	GRC5011/1CR	GRAZIA	273,00	215
ESP233/17	SALA MOSTRA	36,00	531	GRC5012/1CGP	GRAZIA	432,00	215
ESP233/19	SALA MOSTRA	393,00	531	GRC5012/1CR	GRAZIA	270,00	215
ESP233/31NOB	SALA MOSTRA	638,00	530	GRC5015/1CGP	GRAZIA	320,00	216
ESP233/32NOB	SALA MOSTRA	505,00	530	GRC5015/1CR	GRAZIA	200,00	216
ESP233/33NOB	SALA MOSTRA	147,00	531	GRC5101CGP	GRAZIA	707,00	219
ESP233/40	SALA MOSTRA	240,00	533	GRC5101CGP	WELLBOX	707,00	321
ESP233/92S	SALA MOSTRA	365,00	532	GRC5101CR	GRAZIA	442,00	219
ESP233/94S	SALA MOSTRA	285,00	532	GRC5101CR	WELLBOX	442,00	321
FL96113BM	CUCINA NOBILI	284,00	448	GRC5102CGP	GRAZIA	707,00	219
FL96113CR	CUCINA NOBILI	207,00	448	GRC5102CGP	WELLBOX	707,00	325
FL96113IP	CUCINA NOBILI	292,00	450	GRC5102CR	GRAZIA	442,00	219
FL96113NC	CUCINA NOBILI	222,00	448	GRC5102CR	WELLBOX	442,00	325
FL96113WC	CUCINA NOBILI	222,00	448	GRC5103CGP	GRAZIA	1.414,00	220
FL96114CR	CUCINA SPECIALI	373,00	477	GRC5103CGP	WELLBOX	1.414,00	329
FL96114IX	CUCINA SPECIALI	559,00	477	GRC5103CR	GRAZIA	884,00	220
FL96123BM	CUCINA NOBILI	284,00	448	GRC5103CR	WELLBOX	884,00	329
FL96123CR	CUCINA NOBILI	207,00	448	GRC5104CGP	GRAZIA	1.414,00	220
FL96127BM	CUCINA NOBILI	405,00	449	GRC5104CGP	WELLBOX	1.414,00	333
FL96127CR	CUCINA NOBILI	299,00	449	GRC5104CR	GRAZIA	884,00	220
FL96127IP	CUCINA NOBILI	442,00	450	GRC5104CR	WELLBOX	884,00	333
FL96133BM	CUCINA NOBILI	315,00	448	GRC5117/5CR	CUCINA NOBILI	179,00	460
FL96133CR	CUCINA NOBILI	233,00	448	GRC5117CR	CUCINA NOBILI	179,00	460
FL96133IP	CUCINA NOBILI	344,00	450	GRC5118/6CGP	GRAZIA	472,00	215
FL96137BM	CUCINA NOBILI	431,00	448	GRC5118/6CR	GRAZIA	295,00	215
FL96137CR	CUCINA NOBILI	318,00	448	GRC5119/6CGP	GRAZIA	472,00	216
FL96137IP	CUCINA NOBILI	466,00	450	GRC5119/6CR	GRAZIA	295,00	216
FL96137NC	CUCINA NOBILI	351,00	448	HR125300CB	CUCINA NOBILI	479,00	443
FL96137WC	CUCINA NOBILI	351,00	448	HR125300IB	CUCINA NOBILI	646,00	443
FL96300/50CR	CUCINA SPECIALI	603,00	475	IRAV00158/TCGP	VELIS	1.376,00	48
FL96300CR	CUCINA NOBILI	359,00	449	IRAV00158/TCGP	AUSILI SANITARI	1.376,00	490
FL96320/1CR	CUCINA NOBILI	382,00	449	IRAV00158/TCR	VELIS	860,00	48
FL96400/1CR	CUCINA NOBILI	402,00	449	IRAV00158/TCR	AUSILI SANITARI	860,00	490
FL96824/3VBBM	SORGENTE FILTRA	650,00	427	IRAV00158/TGUP	VELIS	1.376,00	48
FL96824/3VBCR	SORGENTE FILTRA	540,00	427	IRAV00158/TGUP	AUSILI SANITARI	1.376,00	490
FL96824/3VBGTP	SORGENTE FILTRA	740,00	427	IRAV00158/TIX	VELIS	1.290,00	48
FL96824/3VBGUP	SORGENTE FILTRA	740,00	427	IRAV00158/TIX	AUSILI SANITARI	1.290,00	490
FL96824/3VBRTTP	SORGENTE FILTRA	740,00	427	IRAV00158/TRCP	VELIS	1.376,00	48
GR05160CGP	GRAZIA	413,00	218	IRAV00158/TRCP	AUSILI SANITARI	1.376,00	490
GR05160CR	GRAZIA	258,00	218	IRAV00158/TRTP	VELIS	1.376,00	48
GR05170CGP	BORDO VASCA	416,00	519	IRAV00158/TRTP	AUSILI SANITARI	1.376,00	490
GR05170CR	BORDO VASCA	260,00	519	IRAV00158/TSB	VELIS	1.376,00	48
GR05204CGP	BORDO VASCA	269,00	514	IRAV00158/TSB	AUSILI SANITARI	1.376,00	490
GR05204CR	BORDO VASCA	168,00	514	IRLP90118/3CR	LOOP	501,00	142
GRC0030/50CGP	COLONNE TERMOSTATICHE	2.109,00	394	IRLP90118/3CR	AUSILI SANITARI	501,00	491
GRC0030/50CR	COLONNE TERMOSTATICHE	1.318,00	394	IRLP90236CR	LOOP	450,00	142

CODICE	COLLEZIONE	EURO	PAG.	CODICE	COLLEZIONE	EURO	PAG.
IRLP90236CR	AUSILI SANITARI	450,00	491	IRVE125236IX	AUSILI SANITARI	629,00	489
IRLV00118/3CR	LIVE	455,00	82	IRVE125236RCP	VELIS	670,00	43
IRLV00118/3CR	AUSILI SANITARI	455,00	490	IRVE125236RCP	AUSILI SANITARI	670,00	489
IRLV00236CR	LIVE	400,00	82	IRVE125236RTP	VELIS	670,00	43
IRLV00236CR	AUSILI SANITARI	400,00	491	IRVE125236RTP	AUSILI SANITARI	670,00	489
IRM1102118/3CR	MIA	561,00	175	IRVE125236SB	VELIS	670,00	43
IRM1102118/3CR	AUSILI SANITARI	561,00	491	IRVE125236SB	AUSILI SANITARI	670,00	489
IRM1102236CR	MIA	509,00	175	IRVE125238CGP	VELIS	741,00	45
IRM1102236CR	AUSILI SANITARI	509,00	492	IRVE125238CGP	AUSILI SANITARI	741,00	490
IRVE125118/3CGP	VELIS	741,00	43	IRVE125238CR	VELIS	463,00	45
IRVE125118/3CGP	AUSILI SANITARI	741,00	489	IRVE125238CR	AUSILI SANITARI	463,00	490
IRVE125118/3CR	VELIS	463,00	43	IRVE125238GUP	VELIS	741,00	45
IRVE125118/3CR	AUSILI SANITARI	463,00	489	IRVE125238GUP	AUSILI SANITARI	741,00	490
IRVE125118/3GUP	VELIS	741,00	43	IRVE125238IX	VELIS	695,00	45
IRVE125118/3GUP	AUSILI SANITARI	741,00	489	IRVE125238IX	AUSILI SANITARI	695,00	490
IRVE125118/3IX	VELIS	695,00	43	IRVE125238RCP	VELIS	741,00	45
IRVE125118/3IX	AUSILI SANITARI	695,00	489	IRVE125238RCP	AUSILI SANITARI	741,00	490
IRVE125118/3RCP	VELIS	741,00	43	IRVE125238RTP	VELIS	741,00	45
IRVE125118/3RCP	AUSILI SANITARI	741,00	489	IRVE125238RTP	AUSILI SANITARI	741,00	490
IRVE125118/3RTP	VELIS	741,00	43	IRVE125238SB	VELIS	741,00	45
IRVE125118/3RTP	AUSILI SANITARI	741,00	489	IRVE125238SB	AUSILI SANITARI	741,00	490
IRVE125118/3SB	VELIS	741,00	43	KL93300/5OCR	CUCINA SPECIALI	558,00	475
IRVE125118/3SB	AUSILI SANITARI	741,00	489	KVR0E600	SALA MOSTRA	108,00	531
IRVE125128/3CGP	VELIS	846,00	45	LK00010/2CR	LIKID	755,00	76
IRVE125128/3CGP	AUSILI SANITARI	846,00	489	LK00010/2CR	TERMOSTATICI ESTERNI	755,00	384
IRVE125128/3CR	VELIS	529,00	45	LK00030CR	LIKID	531,00	76
IRVE125128/3CR	AUSILI SANITARI	529,00	489	LK00030CR	TERMOSTATICI ESTERNI	531,00	378
IRVE125128/3GUP	VELIS	846,00	45	LK00100CR	LIKID	355,00	76
IRVE125128/3GUP	AUSILI SANITARI	846,00	489	LK00101CR	LIKID	417,00	77
IRVE125128/3IX	VELIS	794,00	45	LK00101CR	WELLBOX	417,00	320
IRVE125128/3IX	AUSILI SANITARI	794,00	489	LK00102CR	LIKID	417,00	77
IRVE125128/3RCP	VELIS	846,00	45	LK00102CR	WELLBOX	417,00	324
IRVE125128/3RCP	AUSILI SANITARI	846,00	489	LK00103CR	LIKID	845,00	78
IRVE125128/3RTP	VELIS	846,00	45	LK00103CR	WELLBOX	845,00	328
IRVE125128/3RTP	AUSILI SANITARI	846,00	489	LK00104CR	LIKID	845,00	78
IRVE125128/3SB	VELIS	846,00	45	LK00104CR	WELLBOX	845,00	332
IRVE125128/3SB	AUSILI SANITARI	846,00	489	LK00108CR	LIKID	210,00	76
IRVE125198/1CGP	VELIS	1.499,00	47	LK00113CR	CUCINA NOBILI	289,00	452
IRVE125198/1CGP	AUSILI SANITARI	1.499,00	490	LK00118/2CR	LIKID	478,00	75
IRVE125198/1CR	VELIS	938,00	47	LK00119/2CR	LIKID	488,00	75
IRVE125198/1CR	AUSILI SANITARI	938,00	490	LK00211/2CR	LIKID	620,00	75
IRVE125198/1GUP	VELIS	1.499,00	47	LK00215/2CR	LIKID	602,00	75
IRVE125198/1GUP	AUSILI SANITARI	1.499,00	490	LK00300CR	CUCINA NOBILI	450,00	452
IRVE125198/1IX	VELIS	1.406,00	47	LP90000/5OCR	COLONNE TERMOSTATICHE	4.329,00	397
IRVE125198/1IX	AUSILI SANITARI	1.406,00	490	LP90001/6CR	LOOP	954,00	147
IRVE125198/1RCP	VELIS	1.499,00	47	LP90100/ECR	LOOP	242,00	149
IRVE125198/1RCP	AUSILI SANITARI	1.499,00	490	LP90100/ECR	EASYBOX	242,00	307
IRVE125198/1RTP	VELIS	1.499,00	47	LP90101CR	LOOP	525,00	151
IRVE125198/1RTP	AUSILI SANITARI	1.499,00	490	LP90101CR	WELLBOX	525,00	320
IRVE125198/1SB	VELIS	1.499,00	47	LP90102CR	LOOP	525,00	152
IRVE125198/1SB	AUSILI SANITARI	1.499,00	490	LP90102CR	WELLBOX	525,00	324
IRVE125236CGP	VELIS	670,00	43	LP90103CR	LOOP	826,00	152
IRVE125236CGP	AUSILI SANITARI	670,00	489	LP90103CR	WELLBOX	826,00	328
IRVE125236CR	VELIS	419,00	43	LP90104CR	LOOP	826,00	153
IRVE125236CR	AUSILI SANITARI	419,00	489	LP90104CR	WELLBOX	826,00	332
IRVE125236GUP	VELIS	670,00	43	LP90108CR	LOOP	302,00	149
IRVE125236GUP	AUSILI SANITARI	670,00	489	LP90110/1CR	LOOP	648,00	148
IRVE125236IX	VELIS	629,00	43	LP90110/9CR	BORDO VASCA	360,00	511

CODICE	COLLEZIONE	EURO	PAG.	CODICE	COLLEZIONE	EURO	PAG.
LP90110CR	LOOP	726,00	147	LR116110BM	UNO	589,00	108
LP90118/1CR	LOOP	370,00	141	LR116110CR	UNO	393,00	108
LP90118/2CR	LOOP	368,00	141	LR116118/1BM	UNO	386,00	103
LP90118/3CR	LOOP	382,00	141	LR116118/1CR	UNO	257,00	103
LP90119/1CR	LOOP	370,00	146	LR116118/2BM	UNO	405,00	103
LP90128/2CR	LOOP	464,00	142	LR116118/2CR	UNO	270,00	103
LP90130/30CR	COLONNE MONOCOMANDO	1.611,00	403	LR116118/3BM	UNO	380,00	103
LP90130CR	LOOP	451,00	149	LR116118/3CR	UNO	254,00	103
LP90170CR	BORDO VASCA	268,00	518	LR116119/1BM	UNO	386,00	107
LP90180CR	LOOP	1.408,00	146	LR116119/1CR	UNO	257,00	107
LP90198/1CR	LOOP	479,00	145	LR116128/2BM	UNO	627,00	103
LP90198/1CR	ALLBOX	479,00	293	LR116128/2CR	UNO	418,00	103
LP90198CR	LOOP	446,00	144	LR116130/30BM	COLONNE MONOCOMANDO	1.197,00	402
LP90198CR	ALLBOX	446,00	293	LR116130/30CR	COLONNE MONOCOMANDO	797,00	402
LP90204CR	BORDO VASCA	200,00	513	LR116130BM	UNO	327,00	108
LP90211/1CR	LOOP	552,00	143	LR116130CR	UNO	217,00	108
LP90215/1CR	LOOP	552,00	146	LR116160/T1BM	UNO	347,00	109
LP90236CR	LOOP	202,00	142	LR116160/T1CR	UNO	230,00	109
LP90713CR	CUCINA NOBILI	504,00	457	LR116160BM	LIRA	347,00	202
LPC90118/1CR	LOOP	440,00	141	LR116160CR	LIRA	230,00	202
LPC90128/1CR	LOOP	501,00	143	LR116160GUP	LIRA	368,00	202
LPC90198/1CR	LOOP	528,00	145	LR116170/T1BM	BORDO VASCA	353,00	518
LPC90198/1CR	ALLBOX	528,00	294	LR116170/T1CR	BORDO VASCA	236,00	518
LPC90198CR	LOOP	501,00	144	LR116170BM	BORDO VASCA	353,00	518
LPC90198CR	ALLBOX	501,00	293	LR116170CR	BORDO VASCA	236,00	518
LPC90211/1CR	LOOP	589,00	143	LR116170GUP	BORDO VASCA	378,00	518
LR116100/EBM	UNO	345,00	109	LR116198/1BM	UNO	447,00	105
LR116100/EBM	EASYBOX	345,00	306	LR116198/1BM	ALLBOX	447,00	291
LR116100/ECR	UNO	229,00	109	LR116198/1CR	UNO	299,00	105
LR116100/ECR	EASYBOX	229,00	306	LR116198/1CR	ALLBOX	299,00	291
LR116101BM	LIRA	695,00	203	LR116198BM	UNO	403,00	105
LR116101BM	WELLBOX	695,00	321	LR116198BM	ALLBOX	403,00	291
LR116101CR	LIRA	463,00	203	LR116198CR	UNO	269,00	105
LR116101CR	WELLBOX	463,00	321	LR116198CR	ALLBOX	269,00	291
LR116101GUP	LIRA	741,00	203	LR116204/T1BM	BORDO VASCA	375,00	513
LR116101GUP	WELLBOX	741,00	321	LR116204/T1CR	BORDO VASCA	250,00	513
LR116102BM	LIRA	695,00	203	LR116204BM	BORDO VASCA	375,00	514
LR116102BM	WELLBOX	695,00	325	LR116204CR	BORDO VASCA	250,00	514
LR116102CR	LIRA	463,00	203	LR116204GUP	BORDO VASCA	400,00	514
LR116102CR	WELLBOX	463,00	325	LR116210/1BM	LIRA	614,00	201
LR116102GUP	LIRA	741,00	203	LR116210/1CR	LIRA	410,00	201
LR116102GUP	WELLBOX	741,00	325	LR116210/1GUP	LIRA	656,00	201
LR116103BM	LIRA	1.303,00	204	LR116210/2SBM	LIRA	765,00	200
LR116103BM	WELLBOX	1.303,00	329	LR116210/2SCR	LIRA	510,00	200
LR116103CR	LIRA	868,00	204	LR116210/2SGUP	LIRA	816,00	200
LR116103CR	WELLBOX	868,00	329	LR116210BM	LIRA	765,00	201
LR116103GUP	LIRA	1.389,00	204	LR116210CR	LIRA	510,00	201
LR116103GUP	WELLBOX	1.389,00	329	LR116210GUP	LIRA	816,00	201
LR116104BM	LIRA	1.303,00	204	LR116211/1BM	LIRA	595,00	198
LR116104BM	WELLBOX	1.303,00	333	LR116211/1CR	LIRA	396,00	198
LR116104CR	LIRA	868,00	204	LR116211/1GUP	LIRA	634,00	198
LR116104CR	WELLBOX	868,00	333	LR116211/1T1BM	UNO	595,00	104
LR116104GUP	LIRA	1.389,00	204	LR116211/1T1CR	UNO	396,00	104
LR116104GUP	WELLBOX	1.389,00	333	LR116211/5BM	LIRA	633,00	198
LR116108BM	UNO	261,00	109	LR116211/5CR	LIRA	422,00	198
LR116108CR	UNO	175,00	109	LR116211/5GUP	LIRA	675,00	198
LR116110/1BM	UNO	546,00	108	LR116211/5T1BM	UNO	633,00	104
LR116110/1CR	UNO	364,00	108	LR116211/5T1CR	UNO	422,00	104



CODICE	COLLEZIONE	EURO	PAG.	CODICE	COLLEZIONE	EURO	PAG.
LR116215/1BM	LIRA	595,00	200	LV00010/1BM	TERMOSTATICI ESTERNI	918,00	381
LR116215/1CR	LIRA	396,00	200	LV00010/1CGP	LIVE	978,00	88
LR116215/1GUP	LIRA	634,00	200	LV00010/1CGP	TERMOSTATICI ESTERNI	978,00	381
LR116215/1T1BM	UNO	595,00	107	LV00010/1CR	LIVE	611,00	88
LR116215/1T1CR	UNO	396,00	107	LV00010/1CR	TERMOSTATICI ESTERNI	611,00	381
LR116217CR	CUCINA NOBILI	320,00	459	LV00010/1GUP	LIVE	978,00	88
LR116218/2BM	LIRA	559,00	197	LV00010/1GUP	TERMOSTATICI ESTERNI	978,00	381
LR116218/2CR	LIRA	373,00	197	LV00010/1IX	LIVE	918,00	88
LR116218/2GUP	LIRA	597,00	197	LV00010/1IX	TERMOSTATICI ESTERNI	918,00	381
LR116218/3BM	LIRA	554,00	197	LV00010/1RTP	LIVE	978,00	88
LR116218/3CR	LIRA	370,00	197	LV00010/1RTP	TERMOSTATICI ESTERNI	978,00	381
LR116218/3GUP	LIRA	592,00	197	LV00010/1WM	LIVE	918,00	88
LR116219/2BM	LIRA	559,00	200	LV00010/1WM	TERMOSTATICI ESTERNI	918,00	381
LR116219/2CR	LIRA	373,00	200	LV00010/2BM	LIVE	1.038,00	87
LR116219/2GUP	LIRA	597,00	200	LV00010/2BM	TERMOSTATICI ESTERNI	1.038,00	384
LR116220CR	CUCINA NOBILI	431,00	459	LV00010/2CGP	LIVE	1.107,00	87
LR116228/2BM	LIRA	788,00	197	LV00010/2CGP	TERMOSTATICI ESTERNI	1.107,00	384
LR116228/2CR	LIRA	525,00	197	LV00010/2CR	LIVE	692,00	87
LR116228/2GUP	LIRA	840,00	197	LV00010/2CR	TERMOSTATICI ESTERNI	692,00	384
LR116230/30BM	COLONNE MONOCOMANDO	1.566,00	404	LV00010/2GUP	LIVE	1.107,00	87
LR116230/30CR	COLONNE MONOCOMANDO	1.043,00	404	LV00010/2GUP	TERMOSTATICI ESTERNI	1.107,00	384
LR116230BM	LIRA	517,00	202	LV00010/2IX	LIVE	1.038,00	87
LR116230CR	LIRA	345,00	202	LV00010/2IX	TERMOSTATICI ESTERNI	1.038,00	384
LR116230GUP	LIRA	552,00	202	LV00010/2RTP	LIVE	1.107,00	87
LR116236BM	LIRA	287,00	198	LV00010/2RTP	TERMOSTATICI ESTERNI	1.107,00	384
LR116236CR	LIRA	191,00	198	LV00010/2WM	LIVE	1.038,00	87
LR116236GUP	LIRA	306,00	198	LV00010/2WM	TERMOSTATICI ESTERNI	1.038,00	384
LR116237BM	UNO	311,00	104	LV00030BM	LIVE	732,00	90
LR116237CR	UNO	207,00	104	LV00030BM	TERMOSTATICI ESTERNI	732,00	378
LR116258/2BM	LIRA	712,00	197	LV00030CGP	LIVE	779,00	90
LR116258/2CR	LIRA	476,00	197	LV00030CGP	TERMOSTATICI ESTERNI	779,00	378
LR116258/2GUP	LIRA	762,00	197	LV00030CR	LIVE	487,00	90
LR116298/1EBM	LIRA	420,00	199	LV00030CR	TERMOSTATICI ESTERNI	487,00	378
LR116298/1EBM	ALLBOX	420,00	302	LV00030GUP	LIVE	779,00	90
LR116298/1ECR	LIRA	280,00	199	LV00030GUP	TERMOSTATICI ESTERNI	779,00	378
LR116298/1ECR	ALLBOX	280,00	302	LV00030IX	LIVE	732,00	90
LR116298/1EGUP	LIRA	448,00	199	LV00030IX	TERMOSTATICI ESTERNI	732,00	378
LR116298/1EGUP	ALLBOX	448,00	302	LV00030RTP	LIVE	779,00	90
LR116298/1ET1BM	UNO	420,00	106	LV00030RTP	TERMOSTATICI ESTERNI	779,00	378
LR116298/1ET1BM	ALLBOX	420,00	302	LV00030WM	LIVE	732,00	90
LR116298/1ET1CR	UNO	280,00	106	LV00030WM	TERMOSTATICI ESTERNI	732,00	378
LR116298/1ET1CR	ALLBOX	280,00	302	LV00100/EBM	LIVE	347,00	90
LR116298/EBM	LIRA	396,00	199	LV00100/EBM	EASYBOX	347,00	305
LR116298/EBM	ALLBOX	396,00	302	LV00100/ECGP	LIVE	368,00	90
LR116298/ECR	LIRA	264,00	199	LV00100/ECGP	EASYBOX	368,00	305
LR116298/ECR	ALLBOX	264,00	302	LV00100/ECR	LIVE	230,00	90
LR116298/EGUP	LIRA	422,00	199	LV00100/ECR	EASYBOX	230,00	305
LR116298/EGUP	ALLBOX	422,00	302	LV00100/EGUP	LIVE	368,00	90
LR116298/ET1BM	UNO	396,00	106	LV00100/EGUP	EASYBOX	368,00	305
LR116298/ET1BM	ALLBOX	396,00	302	LV00100/EIX	LIVE	347,00	90
LR116298/ET1CR	UNO	264,00	106	LV00100/EIX	EASYBOX	347,00	305
LR116298/ET1CR	ALLBOX	264,00	302	LV00100/ERTP	LIVE	368,00	90
LRK116208/1BM	LIRA	442,00	202	LV00100/ERTP	EASYBOX	368,00	305
LRK116208/1CR	LIRA	294,00	202	LV00100/EWM	LIVE	347,00	90
LRK116208/1GUP	LIRA	470,00	202	LV00100/EWM	EASYBOX	347,00	305
LRK116208/1T1BM	UNO	442,00	108	LV00108BM	LIVE	249,00	90
LRK116208/1T1CR	UNO	294,00	108	LV00108CGP	LIVE	266,00	90
LV00010/1BM	LIVE	918,00	88	LV00108CR	LIVE	166,00	90

CODICE	COLLEZIONE	EURO	PAG.	CODICE	COLLEZIONE	EURO	PAG.
LV00108GUP	LIVE	266,00	90	LV00119/1GUP	LIVE	392,00	86
LV00108IX	LIVE	249,00	90	LV00119/1IX	LIVE	368,00	86
LV00108RTP	LIVE	266,00	90	LV00119/1RTP	LIVE	392,00	86
LV00108WM	LIVE	249,00	90	LV00119/1WM	LIVE	368,00	86
LV00110/1BM	LIVE	425,00	87	LV00128/2BM	LIVE	434,00	82
LV00110/1CGP	LIVE	454,00	87	LV00128/2CGP	LIVE	462,00	82
LV00110/1CR	LIVE	284,00	87	LV00128/2CR	LIVE	289,00	82
LV00110/1GUP	LIVE	454,00	87	LV00128/2GUP	LIVE	462,00	82
LV00110/1IX	LIVE	425,00	87	LV00128/2IX	LIVE	434,00	82
LV00110/1RTP	LIVE	454,00	87	LV00128/2RTP	LIVE	462,00	82
LV00110/1WM	LIVE	425,00	87	LV00128/2WM	LIVE	434,00	82
LV00110BM	LIVE	546,00	87	LV00130BM	LIVE	396,00	89
LV00110CGP	LIVE	582,00	87	LV00130CGP	LIVE	422,00	89
LV00110CR	LIVE	364,00	87	LV00130CR	LIVE	264,00	89
LV00110GUP	LIVE	582,00	87	LV00130GUP	LIVE	422,00	89
LV00110IX	LIVE	546,00	87	LV00130IX	LIVE	396,00	89
LV00110RTP	LIVE	582,00	87	LV00130RTP	LIVE	422,00	89
LV00110WM	LIVE	546,00	87	LV00130WM	LIVE	396,00	89
LV00113/10CR	CUCINA SPECIALI	318,00	478	LV00133BM	CUCINA NOBILI	257,00	452
LV00113/70CR	CUCINA SPECIALI	292,00	476	LV00133CR	CUCINA NOBILI	171,00	452
LV00113BM	CUCINA NOBILI	355,00	454	LV00133IX	CUCINA NOBILI	257,00	452
LV00113CR	CUCINA NOBILI	261,00	454	LV00133WM	CUCINA NOBILI	257,00	452
LV00113IX	CUCINA NOBILI	393,00	454	LV00134BM	CUCINA NOBILI	257,00	452
LV00113WM	CUCINA NOBILI	355,00	454	LV00134CR	CUCINA NOBILI	171,00	452
LV00117/1BM	CUCINA NOBILI	405,00	454	LV00134IX	CUCINA NOBILI	257,00	452
LV00117/1IX	CUCINA NOBILI	453,00	454	LV00134WM	CUCINA NOBILI	257,00	452
LV00117/1WM	CUCINA NOBILI	405,00	454	LV00137/1CR	CUCINA NOBILI	233,00	453
LV00117/2BM	CUCINA NOBILI	445,00	454	LV00137/1IX	CUCINA NOBILI	350,00	453
LV00117/2CR	CUCINA NOBILI	330,00	454	LV00198/1BM	LIVE	447,00	85
LV00117/2IX	CUCINA NOBILI	495,00	454	LV00198/1BM	ALLBOX	447,00	290
LV00117/71CR	CUCINA SPECIALI	359,00	476	LV00198/1CGP	LIVE	478,00	85
LV00117CR	CUCINA NOBILI	301,00	454	LV00198/1CGP	ALLBOX	478,00	290
LV00118/15BM	LIVE	368,00	81	LV00198/1CR	LIVE	299,00	85
LV00118/15CGP	LIVE	392,00	81	LV00198/1CR	ALLBOX	299,00	290
LV00118/15CR	LIVE	245,00	81	LV00198/1GUP	LIVE	478,00	85
LV00118/15GUP	LIVE	392,00	81	LV00198/1GUP	ALLBOX	478,00	290
LV00118/15IX	LIVE	368,00	81	LV00198/1IX	LIVE	447,00	85
LV00118/15RTP	LIVE	392,00	81	LV00198/1IX	ALLBOX	447,00	290
LV00118/15WM	LIVE	368,00	81	LV00198/1RTP	LIVE	478,00	85
LV00118/16BM	LIVE	387,00	81	LV00198/1RTP	ALLBOX	478,00	290
LV00118/16CGP	LIVE	413,00	81	LV00198/1WM	LIVE	447,00	85
LV00118/16CR	LIVE	258,00	81	LV00198/1WM	ALLBOX	447,00	290
LV00118/16GUP	LIVE	413,00	81	LV00198/2BM	LIVE	491,00	85
LV00118/16IX	LIVE	387,00	81	LV00198/2BM	ALLBOX	491,00	291
LV00118/16RTP	LIVE	413,00	81	LV00198/2CGP	LIVE	525,00	85
LV00118/16WM	LIVE	387,00	81	LV00198/2CGP	ALLBOX	525,00	291
LV00118/40BM	LIVE	406,00	81	LV00198/2CR	LIVE	328,00	85
LV00118/40CGP	LIVE	434,00	81	LV00198/2CR	ALLBOX	328,00	291
LV00118/40CR	LIVE	271,00	81	LV00198/2GUP	LIVE	525,00	85
LV00118/40GUP	LIVE	434,00	81	LV00198/2GUP	ALLBOX	525,00	291
LV00118/40IX	LIVE	406,00	81	LV00198/2IX	LIVE	491,00	85
LV00118/40RTP	LIVE	434,00	81	LV00198/2IX	ALLBOX	491,00	291
LV00118/40WM	LIVE	406,00	81	LV00198/2RTP	LIVE	525,00	85
LV00118/5CR	LIVE	264,00	81	LV00198/2RTP	ALLBOX	525,00	291
LV00118/5IX	LIVE	396,00	81	LV00198/2WM	LIVE	491,00	85
LV00119/1BM	LIVE	368,00	86	LV00198/2WM	ALLBOX	491,00	291
LV00119/1CGP	LIVE	392,00	86	LV00198BM	LIVE	403,00	84
LV00119/1CR	LIVE	245,00	86	LV00198BM	ALLBOX	403,00	290

CODICE	COLLEZIONE	EURO	PAG.	CODICE	COLLEZIONE	EURO	PAG.
LV00198CGP	LIVE	430,00	84	LV00236IX	LIVE	258,00	82
LV00198CGP	ALLBOX	430,00	290	LV00236RTP	LIVE	274,00	82
LV00198CR	LIVE	269,00	84	LV00236WM	LIVE	258,00	82
LV00198CR	ALLBOX	269,00	290	LV00300/3CR	CUCINA NOBILI	246,00	453
LV00198GUP	LIVE	430,00	84	LV00300/3IX	CUCINA NOBILI	370,00	453
LV00198GUP	ALLBOX	430,00	290	LV00713CR	CUCINA NOBILI	259,00	455
LV00198IX	LIVE	403,00	84	LV0K117/EFBMB	SORGENTE FRIZZA	3.050,00	436
LV00198IX	ALLBOX	403,00	290	LV0K117/EFRCR	SORGENTE FRIZZA	2.850,00	436
LV00198RTP	LIVE	430,00	84	LV0K117/EFRIX	SORGENTE FRIZZA	3.050,00	436
LV00198RTP	ALLBOX	430,00	290	LV0K123/EHTBM	SORGENTE BOLLE	1.575,00	432
LV00198WM	LIVE	403,00	84	LV0K123/EHTCR	SORGENTE BOLLE	1.400,00	432
LV00198WM	ALLBOX	403,00	290	LV0K123/EHTIX	SORGENTE BOLLE	1.575,00	432
LV00199/1BM	LIVE	397,00	83	LV0K123/HTBM	SORGENTE BOLLE	1.375,00	431
LV00199/1BM	ALLBOX	397,00	290	LV0K123/HTCR	SORGENTE BOLLE	1.200,00	431
LV00199/1CGP	LIVE	424,00	83	LV0K123/HTIX	SORGENTE BOLLE	1.375,00	431
LV00199/1CGP	ALLBOX	424,00	290	LV0K133/AIOBM	SORGENTE FRIZZA & BOLLE	3.800,00	439
LV00199/1CR	LIVE	265,00	83	LV0K133/AIOCR	SORGENTE FRIZZA & BOLLE	3.600,00	439
LV00199/1CR	ALLBOX	265,00	290	LV0K133/AIOGTP	SORGENTE FRIZZA & BOLLE	3.900,00	439
LV00199/1GUP	LIVE	424,00	83	LV0K133/AIOIX	SORGENTE FRIZZA & BOLLE	3.800,00	439
LV00199/1GUP	ALLBOX	424,00	290	LV0K133/EFBMB	SORGENTE FRIZZA	2.900,00	435
LV00199/1IX	LIVE	397,00	83	LV0K133/EFRCR	SORGENTE FRIZZA	2.700,00	435
LV00199/1IX	ALLBOX	397,00	290	LV0K133/EFRGTP	SORGENTE FRIZZA	3.050,00	435
LV00199/1RTP	LIVE	424,00	83	LV0K133/EFRIX	SORGENTE FRIZZA	2.900,00	435
LV00199/1RTP	ALLBOX	424,00	290	LV0K133/EHTBM	SORGENTE BOLLE	1.575,00	432
LV00199/1WM	LIVE	397,00	83	LV0K133/EHTCR	SORGENTE BOLLE	1.400,00	432
LV00199/1WM	ALLBOX	397,00	290	LV0K133/EHTGTP	SORGENTE BOLLE	1.800,00	432
LV00199/2BM	LIVE	442,00	84	LV0K133/EHTIX	SORGENTE BOLLE	1.575,00	432
LV00199/2BM	ALLBOX	442,00	290	LV0K133/HTBM	SORGENTE BOLLE	1.375,00	431
LV00199/2CGP	LIVE	470,00	84	LV0K133/HTCR	SORGENTE BOLLE	1.200,00	431
LV00199/2CGP	ALLBOX	470,00	290	LV0K133/HTIX	SORGENTE BOLLE	1.375,00	431
LV00199/2CR	LIVE	294,00	84	LV129117/3VBBM	SORGENTE FILTRA	840,00	427
LV00199/2CR	ALLBOX	294,00	290	LV129117/3VBCR	SORGENTE FILTRA	740,00	427
LV00199/2GUP	LIVE	470,00	84	LV129117/3VBIX	SORGENTE FILTRA	840,00	427
LV00199/2GUP	ALLBOX	470,00	290	LV129133/3VBBM	SORGENTE FILTRA	720,00	427
LV00199/2IX	LIVE	442,00	84	LV129133/3VBCR	SORGENTE FILTRA	610,00	427
LV00199/2IX	ALLBOX	442,00	290	LV129133/3VBIX	SORGENTE FILTRA	720,00	427
LV00199/2RTP	LIVE	470,00	84	MH109113BKBM	MATCH	405,00	463
LV00199/2RTP	ALLBOX	470,00	290	MH109113BKCR	MATCH	280,00	463
LV00199/2WM	LIVE	442,00	84	MH109113BKIX	MATCH	405,00	463
LV00199/2WM	ALLBOX	442,00	290	MH109113GBBM	MATCH	405,00	463
LV00199BM	LIVE	353,00	83	MH109113GBCR	MATCH	280,00	463
LV00199BM	ALLBOX	353,00	289	MH109113GBIX	MATCH	405,00	463
LV00199CGP	LIVE	378,00	83	MH109113GLBM	MATCH	405,00	463
LV00199CGP	ALLBOX	378,00	289	MH109113GLCR	MATCH	280,00	463
LV00199CR	LIVE	236,00	83	MH109113GLIX	MATCH	405,00	463
LV00199CR	ALLBOX	236,00	289	MH109113NIBM	MATCH	405,00	463
LV00199GUP	LIVE	378,00	83	MH109113NICR	MATCH	280,00	463
LV00199GUP	ALLBOX	378,00	289	MH109113NIIX	MATCH	405,00	463
LV00199IX	LIVE	353,00	83	MH109113RJBM	MATCH	405,00	463
LV00199IX	ALLBOX	353,00	289	MH109113RJCR	MATCH	280,00	463
LV00199RTP	LIVE	378,00	83	MH109113RJIX	MATCH	405,00	463
LV00199RTP	ALLBOX	378,00	289	MH109113ZDBM	MATCH	405,00	463
LV00199WM	LIVE	353,00	83	MH109113ZDCR	MATCH	280,00	463
LV00199WM	ALLBOX	353,00	289	MH109113ZDIX	MATCH	405,00	463
LV00236BM	LIVE	258,00	82	MII02100/EBM	MIA	478,00	181
LV00236CGP	LIVE	274,00	82	MII02100/EBM	EASYBOX	478,00	308
LV00236CR	LIVE	171,00	82	MII02100/ECR	MIA	318,00	181
LV00236GUP	LIVE	274,00	82	MII02100/ECR	EASYBOX	318,00	308

CODICE	COLLEZIONE	EURO	PAG.	CODICE	COLLEZIONE	EURO	PAG.
MI102100/EIX	MIA	478,00	181	MQ102010IX	MIA	1.273,00	179
MI102100/EIX	EASYBOX	478,00	308	MQ102010IX	TERMOSTATICI ESTERNI	1.273,00	385
MI102108BM	MIA	581,00	181	MQ102030BM	MIA	794,00	181
MI102108CR	MIA	389,00	181	MQ102030BM	TERMOSTATICI ESTERNI	794,00	379
MI102108IX	MIA	581,00	181	MQ102030CR	MIA	529,00	181
MI102114CR	CUCINA SPECIALI	501,00	477	MQ102030CR	TERMOSTATICI ESTERNI	529,00	379
MI102118/1BM	MIA	533,00	175	MQ102030IX	MIA	794,00	181
MI102118/1CR	MIA	355,00	175	MQ102030IX	TERMOSTATICI ESTERNI	794,00	379
MI102118/1IX	MIA	533,00	175	MQ102110/1BM	MIA	1.093,00	179
MI102118/2BM	MIA	552,00	175	MQ102110/1CR	MIA	730,00	179
MI102118/2CR	MIA	369,00	175	MQ102110/1IX	MIA	1.093,00	179
MI102118/2IX	MIA	552,00	175	MQ102110BM	MIA	1.273,00	179
MI102119/1BM	MIA	559,00	177	MQ102110CR	MIA	847,00	179
MI102119/1CR	MIA	373,00	177	MQ102110IX	MIA	1.273,00	179
MI102119/1IX	MIA	559,00	177	MQ102130BM	MIA	794,00	180
MI102119/2BM	MIA	579,00	177	MQ102130CR	MIA	529,00	180
MI102119/2CR	MIA	386,00	177	MQ102130IX	MIA	794,00	180
MI102119/2IX	MIA	579,00	177	MV123300BM	CUCINA NOBILI	830,00	443
MI102128/2BM	MIA	872,00	176	MV123300CR	CUCINA NOBILI	552,00	443
MI102128/2CR	MIA	580,00	176	MV123300IX	CUCINA NOBILI	830,00	443
MI102128/2IX	MIA	872,00	176	MV92300/50BM	CUCINA NOBILI	761,00	443
MI102158/2BM	MIA	698,00	176	MV92300/50CR	CUCINA NOBILI	507,00	443
MI102158/2CR	MIA	465,00	176	MV92300/50IX	CUCINA NOBILI	761,00	443
MI102158/2IX	MIA	698,00	176	MV92400/50BM	CUCINA NOBILI	711,00	443
MI102198/1BM	MIA	889,00	177	MV92400/50CR	CUCINA NOBILI	473,00	443
MI102198/1BM	ALLBOX	889,00	295	MV92400/50IX	CUCINA NOBILI	711,00	443
MI102198/1CR	MIA	593,00	177	NB84100CR	NOBI	160,00	241
MI102198/1CR	ALLBOX	593,00	295	NB84108CR	NOBI	72,00	241
MI102198/1IX	MIA	889,00	177	NB84110/1CR	NOBI	170,00	240
MI102198/1IX	ALLBOX	889,00	295	NB84110CR	NOBI	193,00	240
MI102198BM	MIA	839,00	176	NB84113/25CR	CUCINA ENNE	151,00	471
MI102198BM	ALLBOX	839,00	295	NB84130/30CR	COLONNE MONOCOMANDO	770,00	407
MI102198CR	MIA	559,00	176	NB84130CR	NOBI	140,00	240
MI102198CR	ALLBOX	559,00	295	NB84338/2CR	NOBI	332,00	239
MI102198IX	MIA	839,00	176	NBH84118/1CR	NOBI	108,00	239
MI102198IX	ALLBOX	839,00	295	NBH84118/2CR	NOBI	105,00	239
MI102713CR	CUCINA NOBILI	609,00	458	NBH84119/1CR	NOBI	108,00	240
MI102713IX	CUCINA NOBILI	912,00	458	NBH84128/2CR	NOBI	290,00	239
MP117133CR	CUCINA ENNE	222,00	469	NR00202/1CGP	COMPLEMENTI	22,00	506
MP117137CR	CUCINA ENNE	344,00	469	NR00202/1CR	COMPLEMENTI	14,00	506
MP118300CR	CUCINA NOBILI	400,00	444	NR00202/1SB	COMPLEMENTI	22,00	506
MP118300IX	CUCINA NOBILI	600,00	444	NR00238/19CGP	BORDO VASCA	174,00	520
MP119400BM	CUCINA NOBILI	614,00	444	NR00238/19CR	BORDO VASCA	109,00	520
MP119400CR	CUCINA NOBILI	410,00	444	NR00238/20CR	BORDO VASCA	149,00	520
MP119400IX	CUCINA NOBILI	614,00	444	NR00238/21BM	BORDO VASCA	195,00	520
MP120300CR	CUCINA NOBILI	383,00	444	NR00238/21CR	BORDO VASCA	137,00	520
MP120300IX	CUCINA NOBILI	574,00	444	NR00238/21IX	BORDO VASCA	195,00	520
MP121300CR	CUCINA NOBILI	369,00	444	NR00238/22BM	BORDO VASCA	151,00	519
MQ102010/1BM	MIA	1.093,00	179	NR00238/22CGP	BORDO VASCA	170,00	519
MQ102010/1BM	TERMOSTATICI ESTERNI	1.093,00	382	NR00238/22CR	BORDO VASCA	106,00	519
MQ102010/1CR	MIA	730,00	179	NR00238/22GUP	BORDO VASCA	170,00	519
MQ102010/1CR	TERMOSTATICI ESTERNI	730,00	382	NR00238/22IX	BORDO VASCA	151,00	519
MQ102010/1IX	MIA	1.093,00	179	NR00238/22RCP	BORDO VASCA	170,00	519
MQ102010/1IX	TERMOSTATICI ESTERNI	1.093,00	382	NR00238/22RTP	BORDO VASCA	170,00	519
MQ102010BM	MIA	1.273,00	179	NR00238/22SB	BORDO VASCA	170,00	519
MQ102010BM	TERMOSTATICI ESTERNI	1.273,00	385	NR00238/22WM	BORDO VASCA	151,00	519
MQ102010CR	MIA	847,00	179	NR00238/26BM	BORDO VASCA	164,00	519
MQ102010CR	TERMOSTATICI ESTERNI	847,00	385	NR00238/26CR	BORDO VASCA	116,00	519

CODICE	COLLEZIONE	EURO	PAG.	CODICE	COLLEZIONE	EURO	PAG.
NR00238/26GUP	BORDO VASCA	186,00	519	RAEK222/22	AERATORI	45,00	545
NR00238/28CR	BORDO VASCA	167,00	519	RAEK222/23	AERATORI	43,00	545
NR00238/28GUP	BORDO VASCA	267,00	519	RAEK222/26	AERATORI	45,00	545
NR00238/28IX	BORDO VASCA	251,00	519	RAEK222/27	AERATORI	45,00	546
NR00238/28RTP	BORDO VASCA	267,00	519	RAEK222/28	AERATORI	93,00	547
NR00238/28SB	BORDO VASCA	267,00	519	RAEK222/42	AERATORI	45,00	545
NU12513/4CR	CUCINA SPECIALI	332,00	477	RAEK222/44	AERATORI	61,00	545
NU12513/8CR	CUCINA ENNE	337,00	469	RAEK222/45	AERATORI	63,00	545
NU12513CR	CUCINA ENNE	232,00	469	RCR107040	CARTUCCE E VITONI	18,00	538
OZ45113CR	CUCINA ENNE	221,00	468	RCR200/33S	CARTUCCE E VITONI	39,00	538
OZ45300/3CR	CUCINA ENNE	332,00	468	RCR200/37	CARTUCCE E VITONI	39,00	538
OZ713/T5CR	CUCINA ENNE	246,00	468	RCR201/28	CARTUCCE E VITONI	39,00	538
PN115030/30BCR	COLONNE TERMOSTATICHE	1.742,00	389	RCR201/35FSC	CARTUCCE E VITONI	39,00	539
PN115030/30CR	COLONNE TERMOSTATICHE	1.742,00	389	RCR201/35C	CARTUCCE E VITONI	39,00	539
PN115030BCR	TERMOSTATICI ESTERNI	435,00	377	RCR201/40	CARTUCCE E VITONI	132,00	540
PN115030CR	TERMOSTATICI ESTERNI	435,00	377	RCR201/45	CARTUCCE E VITONI	21,00	539
PO108113CR	CUCINA NOBILI	205,00	446	RCR201/5	CARTUCCE E VITONI	58,00	539
PO108127CR	CUCINA NOBILI	281,00	446	RCR201/56	CARTUCCE E VITONI	58,00	539
PO108137CR	CUCINA NOBILI	281,00	446	RCR201/56A	CARTUCCE E VITONI	58,00	540
QD00030/50BM	COLONNE TERMOSTATICHE	1.725,00	393	RCR201/57	CARTUCCE E VITONI	51,00	539
QD00030/50CR	COLONNE TERMOSTATICHE	1.150,00	393	RCR201/59	CARTUCCE E VITONI	51,00	539
QD00030/50IX	COLONNE TERMOSTATICHE	1.725,00	393	RCR201/6	CARTUCCE E VITONI	58,00	539
RAE219/22CR	AERATORI	22,00	545	RCR201/70	CARTUCCE E VITONI	39,00	539
RAE219/280CR	AERATORI	27,00	546	RCR201/70SC	CARTUCCE E VITONI	39,00	539
RAE219/28CR	AERATORI	22,00	546	RCR2020	CARTUCCE E VITONI	41,00	537
RAE219/47CR	AERATORI	23,00	543	RCR280/D	CARTUCCE E VITONI	39,00	537
RAE219/61CR	AERATORI	23,00	544	RCR280/DECO	CARTUCCE E VITONI	50,00	537
RAE219/64CR	AERATORI	23,00	544	RCR284/D	CARTUCCE E VITONI	39,00	537
RAE220/37CR	AERATORI	21,00	544	RCR340	CARTUCCE E VITONI	39,00	537
RAE220/40CR	AERATORI	22,00	543	RCR350	CARTUCCE E VITONI	39,00	537
RAE220/51CR	AERATORI	21,00	546	RCR350/D	CARTUCCE E VITONI	39,00	537
RAE222/24CR	AERATORI	17,00	546	RCR350/DCL	CARTUCCE E VITONI	39,00	537
RAE222/25CR	AERATORI	21,00	546	RCR350/ECO	CARTUCCE E VITONI	48,00	537
RAE222/43CR	AERATORI	29,00	547	RCR35000/B	CARTUCCE E VITONI	44,00	538
RAEK219/14CR	AERATORI	58,00	544	RCR35000/V	CARTUCCE E VITONI	44,00	538
RAEK219/23CR	AERATORI	61,00	544	RCR360/D	CARTUCCE E VITONI	39,00	537
RAEK219/27	AERATORI	96,00	547	RCR360/DCL	CARTUCCE E VITONI	39,00	538
RAEK219/28	AERATORI	58,00	545	RCR440	CARTUCCE E VITONI	39,00	538
RAEK219/280	AERATORI	61,00	545	RCR450	CARTUCCE E VITONI	39,00	538
RAEK219/38CR	AERATORI	100,00	546	RCR465	CARTUCCE E VITONI	41,00	538
RAEK219/41CR	AERATORI	47,00	543	RD00100CR	NEW ROAD	161,00	262
RAEK219/43CR	AERATORI	38,00	543	RD00108CR	NEW ROAD	72,00	261
RAEK219/44CR	AERATORI	27,00	544	RD00110/1CR	NEW ROAD	145,00	260
RAEK219/4CR	AERATORI	43,00	544	RD00110CR	NEW ROAD	193,00	260
RAEK219/63CR	AERATORI	53,00	543	RD00117CR	CUCINA ENNE	183,00	473
RAEK219/67CR	AERATORI	75,00	543	RD00118/10CR	NEW ROAD	190,00	259
RAEK219/73CR	AERATORI	65,00	547	RD00127/1T7CR	CUCINA ENNE	191,00	473
RAEK220/14CR	AERATORI	45,00	544	RD00130/30CR	COLONNE MONOCOMANDO	770,00	409
RAEK220/27CR	AERATORI	43,00	546	RD00130CR	NEW ROAD	140,00	261
RAEK220/32CR	AERATORI	45,00	544	RD00198/1CR	NEW ROAD	270,00	259
RAEK220/35CR	AERATORI	29,00	543	RD00198/1CR	ALLBOX	270,00	299
RAEK220/36CR	AERATORI	53,00	543	RD00198CR	NEW ROAD	244,00	258
RAEK220/37CR	AERATORI	47,00	543	RD00198CR	ALLBOX	244,00	298
RAEK220/66CR	AERATORI	47,00	543	RD00199/1CR	NEW ROAD	254,00	258
RAEK221/4CR	AERATORI	45,00	544	RD00199/1CR	ALLBOX	254,00	298
RAEK222/10CR	AERATORI	58,00	546	RD00199CR	NEW ROAD	226,00	257
RAEK222/12CR	AERATORI	69,00	546	RD00199CR	ALLBOX	226,00	298
RAEK222/20	AERATORI	58,00	545	RD00338/2CR	NEW ROAD	333,00	257

CODICE	COLLEZIONE	EURO	PAG.	CODICE	COLLEZIONE	EURO	PAG.
RD00410/1CR	NEW ROAD	343,00	260	SA99100CR	SAND	170,00	245
RD00410/1CR	TERMOSTATICI ESTERNI	343,00	383	SA99108CR	SAND	75,00	245
RD00410CR	NEW ROAD	399,00	260	SA99110/1CR	SAND	181,00	244
RD00410CR	TERMOSTATICI ESTERNI	399,00	386	SA99110CR	SAND	205,00	244
RD00430CR	NEW ROAD	239,00	261	SA99113/25CR	CUCINA ENNE	135,00	471
RD00430CR	TERMOSTATICI ESTERNI	239,00	380	SA99117CR	CUCINA ENNE	177,00	472
RDC0118/2CR	NEW ROAD	250,00	255	SA99130/30CR	COLONNE MONOCOMANDO	770,00	407
RDC0128/2CR	NEW ROAD	465,00	256	SA99130/51CR	COLONNE MONOCOMANDO	995,00	408
RDC0158/2CR	NEW ROAD	440,00	256	SA99130/52CR	COLONNE MONOCOMANDO	524,00	408
RDE0113/25CR	CUCINA ENNE	146,00	472	SA99130CR	SAND	147,00	244
RDE0113/27T7CR	CUCINA ENNE	159,00	473	SA99338/2CR	SAND	315,00	243
RDE0123/1T7CR	CUCINA ENNE	147,00	473	SAH99118/1CR	SAND	120,00	243
RDH00118/1CR	NEW ROAD	132,00	255	SAH99118/2CR	SAND	117,00	243
RDH00118/20CR	NEW ROAD	180,00	255	SAH99119/1CR	SAND	120,00	244
RDH00118/2CR	NEW ROAD	129,00	255	SAH99128/2CR	SAND	282,00	243
RDH00119/1CR	NEW ROAD	132,00	259	SE124030/30BM	COLONNE TERMOSTATICHE	1.151,00	392
RDH00128/2CR	NEW ROAD	330,00	256	SE124030/30CR	COLONNE TERMOSTATICHE	768,00	392
RDH00158/2CR	NEW ROAD	306,00	256	SE124030/30IX	COLONNE TERMOSTATICHE	1.151,00	392
RKTBWT/FIL	SORGENTE FILTRA	253,00	429	SE124030BM	SEVEN	328,00	128
RKTCLA/FIL	SORGENTE BOLLE	353,00	433	SE124030BM	TERMOSTATICI ESTERNI	328,00	378
RNI152/26BCR	COMPLEMENTI	15,00	505	SE124030CR	SEVEN	218,00	128
RVR93094	SORGENTE FILTRA	100,00	428	SE124030CR	TERMOSTATICI ESTERNI	218,00	378
RVR93094/CLA	SORGENTE BOLLE	100,00	433	SE124030IX	SEVEN	328,00	128
RVR93095	SORGENTE FILTRA	103,00	428	SE124030IX	TERMOSTATICI ESTERNI	328,00	378
RVR93095/M	SORGENTE FILTRA	159,00	428	SE124100/EBM	SEVEN	244,00	129
RVR93096	SORGENTE FILTRA	90,00	428	SE124100/EBM	EASYBOX	244,00	306
RVR93096/CLA	SORGENTE BOLLE	198,00	433	SE124100/ECR	SEVEN	162,00	129
RVT200/10	CARTUCCE E VITONI	18,00	540	SE124100/ECR	EASYBOX	162,00	306
RVT200/26	CARTUCCE E VITONI	18,00	540	SE124100/EIX	SEVEN	244,00	129
RVT200/28	CARTUCCE E VITONI	21,00	540	SE124100/EIX	EASYBOX	244,00	306
RVT200/30	CARTUCCE E VITONI	30,00	540	SE124108BM	SEVEN	164,00	128
RVT200/31	CARTUCCE E VITONI	74,00	540	SE124108CR	SEVEN	109,00	128
RVT200/40	CARTUCCE E VITONI	139,00	541	SE124108IX	SEVEN	164,00	128
RVT200/5D	CARTUCCE E VITONI	18,00	540	SE124110/1BM	SEVEN	347,00	127
RVT200/5S	CARTUCCE E VITONI	18,00	540	SE124110/1CR	SEVEN	230,00	127
RVT200/73	CARTUCCE E VITONI	20,00	540	SE124110/1IX	SEVEN	347,00	127
RY00010/1CR	RAY	698,00	168	SE124110BM	SEVEN	486,00	127
RY00010/1CR	TERMOSTATICI ESTERNI	698,00	382	SE124110CR	SEVEN	324,00	127
RY00010CR	RAY	815,00	168	SE124110IX	SEVEN	486,00	127
RY00010CR	TERMOSTATICI ESTERNI	815,00	385	SE124118/1BM	SEVEN	272,00	123
RY00030CR	RAY	508,00	169	SE124118/1CR	SEVEN	182,00	123
RY00030CR	TERMOSTATICI ESTERNI	508,00	379	SE124118/1IX	SEVEN	272,00	123
RY00100/ECR	RAY	318,00	169	SE124118/2BM	SEVEN	294,00	124
RY00100/ECR	EASYBOX	318,00	307	SE124118/2CR	SEVEN	195,00	124
RY00108CR	RAY	372,00	169	SE124118/2IX	SEVEN	294,00	124
RY00110/1CR	RAY	700,00	168	SE124118/3BM	SEVEN	268,00	124
RY00110CR	RAY	815,00	167	SE124118/3CR	SEVEN	179,00	124
RY00118/1CR	RAY	408,00	165	SE124118/3IX	SEVEN	268,00	124
RY00118/2CR	RAY	421,00	165	SE124119/1BM	SEVEN	272,00	126
RY00119/1CR	RAY	417,00	167	SE124119/1CR	SEVEN	182,00	126
RY00119/2CR	RAY	431,00	167	SE124119/1IX	SEVEN	272,00	126
RY00128/2CR	RAY	647,00	165	SE124128/2BM	SEVEN	549,00	124
RY00130CR	RAY	509,00	168	SE124128/2CR	SEVEN	366,00	124
RY00158/2CR	RAY	529,00	165	SE124128/2IX	SEVEN	549,00	124
RY00198/1CR	RAY	570,00	166	SE124130BM	SEVEN	280,00	128
RY00198/1CR	ALLBOX	570,00	295	SE124130CR	SEVEN	186,00	128
RY00198CR	RAY	537,00	166	SE124130IX	SEVEN	280,00	128
RY00198CR	ALLBOX	537,00	294	SE124198/1BM	SEVEN	457,00	125

CODICE	COLLEZIONE	EURO	PAG.	CODICE	COLLEZIONE	EURO	PAG.
SE124198/1BM	ALLBOX	457,00	292	SI98128/2CR	SOFI	389,00	187
SE124198/1CR	SEVEN	305,00	125	SI98128/2SB	SOFI	622,00	187
SE124198/1CR	ALLBOX	305,00	292	SI98130CR	SOFI	420,00	190
SE124198/1IX	SEVEN	457,00	125	SI98130SB	SOFI	672,00	190
SE124198/1IX	ALLBOX	457,00	292	SI98198/1CR	SOFI	355,00	188
SE124198BM	SEVEN	413,00	125	SI98198/1CR	ALLBOX	355,00	296
SE124198BM	ALLBOX	413,00	292	SI98198/1SB	SOFI	568,00	188
SE124198CR	SEVEN	274,00	125	SI98198/1SB	ALLBOX	568,00	296
SE124198CR	ALLBOX	274,00	292	SI98198CR	SOFI	280,00	188
SE124198IX	SEVEN	413,00	125	SI98198CR	ALLBOX	280,00	295
SE124198IX	ALLBOX	413,00	292	SI98198SB	SOFI	448,00	188
SEE124118/1BM	SEVEN	274,00	123	SI98198SB	ALLBOX	448,00	295
SEE124118/1CR	SEVEN	183,00	123	SI98211/1CR	SOFI	431,00	187
SEE124118/1IX	SEVEN	274,00	123	SI98211/1SB	SOFI	690,00	187
SEE124118/2BM	SEVEN	294,00	123	SI98215/1CR	SOFI	431,00	189
SEE124118/2CR	SEVEN	196,00	123	SI98215/1SB	SOFI	690,00	189
SEE124118/2IX	SEVEN	294,00	123	SN00113/25CR	CUCINA ENNE	123,00	467
SEE124118/3BM	SEVEN	270,00	123	SN00113/28CR	CUCINA ENNE	116,00	467
SEE124118/3CR	SEVEN	180,00	123	SN00713BM	CUCINA ENNE	219,00	467
SEE124118/3IX	SEVEN	270,00	123	SN00713CR	CUCINA ENNE	162,00	467
SEE124119/1BM	SEVEN	274,00	126	SN00713IX	CUCINA ENNE	244,00	467
SEE124119/1CR	SEVEN	183,00	126	SN00717BM	CUCINA ENNE	276,00	467
SEE124119/1IX	SEVEN	274,00	126	SN00717CR	CUCINA ENNE	204,00	467
SEE124128/2BM	SEVEN	551,00	124	SN00717IX	CUCINA ENNE	306,00	467
SEE124128/2CR	SEVEN	368,00	124	SO130101CR	SOLE	460,00	37
SEE124128/2IX	SEVEN	551,00	124	SO130101CR	WELLBOX	460,00	319
SI98100/ECR	SOFI	285,00	191	SO130101CR	WELLBOX	460,00	323
SI98100/ECR	EASYBOX	285,00	308	SO130101GUP	SOLE	736,00	37
SI98100/ESB	SOFI	456,00	191	SO130101GUP	WELLBOX	736,00	319
SI98100/ESB	EASYBOX	456,00	308	SO130101GUP	WELLBOX	736,00	323
SI98101CR	SOFI	417,00	192	SO130101IX	SOLE	690,00	37
SI98101CR	WELLBOX	417,00	321	SO130101IX	WELLBOX	690,00	319
SI98101SB	SOFI	667,00	192	SO130101IX	WELLBOX	690,00	323
SI98101SB	WELLBOX	667,00	321	SO130101RTP	SOLE	736,00	37
SI98102CR	SOFI	417,00	193	SO130101RTP	WELLBOX	736,00	319
SI98102CR	WELLBOX	417,00	325	SO130101RTP	WELLBOX	736,00	323
SI98102SB	SOFI	667,00	193	SO130101SB	SOLE	736,00	37
SI98102SB	WELLBOX	667,00	325	SO130101SB	WELLBOX	736,00	319
SI98103CR	SOFI	845,00	193	SO130101SB	WELLBOX	736,00	323
SI98103CR	WELLBOX	845,00	329	SO130103CR	SOLE	952,00	38
SI98103SB	SOFI	1.352,00	193	SO130103CR	WELLBOX	952,00	327
SI98103SB	WELLBOX	1.352,00	329	SO130103CR	WELLBOX	952,00	331
SI98104CR	SOFI	845,00	194	SO130103GUP	SOLE	1.523,00	38
SI98104CR	WELLBOX	845,00	333	SO130103GUP	WELLBOX	1.523,00	327
SI98104SB	SOFI	1.352,00	194	SO130103GUP	WELLBOX	1.523,00	331
SI98104SB	WELLBOX	1.352,00	333	SO130103IX	SOLE	1.428,00	38
SI98108CR	SOFI	300,00	190	SO130103IX	WELLBOX	1.428,00	327
SI98108SB	SOFI	480,00	190	SO130103IX	WELLBOX	1.428,00	331
SI98110/1CR	SOFI	530,00	189	SO130103RTP	SOLE	1.523,00	38
SI98110/1SB	SOFI	848,00	189	SO130103RTP	WELLBOX	1.523,00	327
SI98110CR	SOFI	757,00	189	SO130103RTP	WELLBOX	1.523,00	331
SI98110SB	SOFI	1.211,00	189	SO130103SB	SOLE	1.523,00	38
SI98113CR	CUCINA NOBILI	316,00	458	SO130103SB	WELLBOX	1.523,00	327
SI98118/1CR	SOFI	293,00	187	SO130103SB	WELLBOX	1.523,00	331
SI98118/1SB	SOFI	469,00	187	SO130118/2CR	SOLE	388,00	29
SI98119/1CR	SOFI	293,00	189	SO130118/2GUP	SOLE	621,00	29
SI98119/1SB	SOFI	469,00	189	SO130118/2IX	SOLE	582,00	29
SI98127CR	CUCINA NOBILI	402,00	458	SO130118/2RTP	SOLE	621,00	29

CODICE	COLLEZIONE	EURO	PAG.	CODICE	COLLEZIONE	EURO	PAG.
SO130118/2SB	SOLE	621,00	29	SO130211/2IX	SOLE	780,00	30
SO130118/3CR	SOLE	372,00	29	SO130211/2RTP	SOLE	832,00	30
SO130118/3GUP	SOLE	595,00	29	SO130211/2SB	SOLE	832,00	30
SO130118/3IX	SOLE	558,00	29	SO130215/2CR	SOLE	520,00	33
SO130118/3RTP	SOLE	595,00	29	SO130215/2GUP	SOLE	832,00	33
SO130118/3SB	SOLE	595,00	29	SO130215/2IX	SOLE	780,00	33
SO130119/2CR	SOLE	388,00	32	SO130215/2RTP	SOLE	832,00	33
SO130119/2GUP	SOLE	621,00	32	SO130215/2SB	SOLE	832,00	33
SO130119/2IX	SOLE	582,00	32	SO130298/ECR	SOLE	372,00	31
SO130119/2RTP	SOLE	621,00	32	SO130298/ECR	ALLBOX	372,00	301
SO130119/2SB	SOLE	621,00	32	SO130298/EGUP	SOLE	595,00	31
SO130119/3CR	SOLE	372,00	32	SO130298/EGUP	ALLBOX	595,00	301
SO130119/3GUP	SOLE	595,00	32	SO130298/EIX	SOLE	558,00	31
SO130119/3IX	SOLE	558,00	32	SO130298/EIX	ALLBOX	558,00	301
SO130119/3RTP	SOLE	595,00	32	SO130298/ERTP	SOLE	595,00	31
SO130119/3SB	SOLE	595,00	32	SO130298/ERTP	ALLBOX	595,00	301
SO130128/2CR	SOLE	481,00	29	SO130298/ESB	SOLE	595,00	31
SO130128/2GUP	SOLE	770,00	29	SO130298/ESB	ALLBOX	595,00	301
SO130128/2IX	SOLE	722,00	29	SO130318/3ECR	SOLE	862,00	32
SO130128/2RTP	SOLE	770,00	29	SO130318/3EGUP	SOLE	1.379,00	32
SO130128/2SB	SOLE	770,00	29	SO130318/3EIX	SOLE	1.293,00	32
SO130128/3CR	SOLE	465,00	29	SO130318/3ERTP	SOLE	1.379,00	32
SO130128/3GUP	SOLE	744,00	29	SO130318/3ESB	SOLE	1.379,00	32
SO130128/3IX	SOLE	698,00	29	SOK130208CR	SOLE	265,00	36
SO130128/3RTP	SOLE	744,00	29	SOK130208GUP	SOLE	424,00	36
SO130128/3SB	SOLE	744,00	29	SOK130208IX	SOLE	398,00	36
SO130160CR	SOLE	256,00	36	SOK130208RTP	SOLE	424,00	36
SO130160GUP	SOLE	410,00	36	SOK130208SB	SOLE	424,00	36
SO130160IX	SOLE	384,00	36	SY97010/1CR	SKY	362,00	251
SO130160RTP	SOLE	410,00	36	SY97010/1CR	TERMOSTATICI ESTERNI	362,00	383
SO130160SB	SOLE	410,00	36	SY97010CR	SKY	422,00	250
SO130170CR	BORDO VASCA	271,00	516	SY97010CR	TERMOSTATICI ESTERNI	422,00	386
SO130170GUP	BORDO VASCA	434,00	516	SY97030CR	SKY	217,00	251
SO130170IX	BORDO VASCA	407,00	516	SY97030CR	TERMOSTATICI ESTERNI	217,00	380
SO130170RTP	BORDO VASCA	434,00	516	SY97100CR	SKY	158,00	252
SO130170SB	BORDO VASCA	434,00	516	SY97108CR	SKY	70,00	251
SO130188/3CR	SOLE	905,00	31	SY97110/1CR	SKY	181,00	250
SO130188/3GUP	SOLE	1.448,00	31	SY97110CR	SKY	232,00	250
SO130188/3IX	SOLE	1.358,00	31	SY97113/25CR	CUCINA ENNE	114,00	472
SO130188/3RTP	SOLE	1.448,00	31	SY97116/1CR	SKY	98,00	247
SO130188/3SB	SOLE	1.448,00	31	SY97117CR	CUCINA ENNE	193,00	472
SO130198CR	SOLE	330,00	30	SY97130/30CR	COLONNE MONOCOMANDO	770,00	409
SO130198CR	ALLBOX	330,00	287	SY97130CR	SKY	167,00	251
SO130198GUP	SOLE	528,00	30	SY97198/1CR	SKY	208,00	249
SO130198GUP	ALLBOX	528,00	287	SY97198/1CR	ALLBOX	208,00	298
SO130198IX	SOLE	495,00	30	SY97198CR	SKY	186,00	249
SO130198IX	ALLBOX	495,00	287	SY97198CR	ALLBOX	186,00	297
SO130198RTP	SOLE	528,00	30	SY97199/1CR	SKY	193,00	248
SO130198RTP	ALLBOX	528,00	287	SY97199/1CR	ALLBOX	193,00	297
SO130198SB	SOLE	528,00	30	SY97199CR	SKY	172,00	248
SO130198SB	ALLBOX	528,00	287	SY97199CR	ALLBOX	172,00	297
SO130204CR	BORDO VASCA	265,00	512	SYH97118/1CR	SKY	125,00	247
SO130204GUP	BORDO VASCA	424,00	512	SYH97118/2CR	SKY	122,00	247
SO130204IX	BORDO VASCA	398,00	512	SYH97119/1CR	SKY	125,00	250
SO130204RTP	BORDO VASCA	424,00	512	TD85330/52BM	COLONNE TERMOSTATICHE	1.199,00	391
SO130204SB	BORDO VASCA	424,00	512	TD85330/52CGP	COLONNE TERMOSTATICHE	1.278,00	391
SO130211/2CR	SOLE	520,00	30	TD85330/52CR	COLONNE TERMOSTATICHE	799,00	391
SO130211/2GUP	SOLE	832,00	30	TD85330/52GUP	COLONNE TERMOSTATICHE	1.278,00	391



CODICE	COLLEZIONE	EURO	PAG.	CODICE	COLLEZIONE	EURO	PAG.
TD85330/52IX	COLONNE TERMOSTATICHE	1.199,00	391	UP94104CR	UP	783,00	162
TD85330/52WM	COLONNE TERMOSTATICHE	1.199,00	391	UP94104CR	WELLBOX	783,00	332
TD85330/53CR	COLONNE TERMOSTATICHE	819,00	391	UP94108BM	UP	239,00	159
TG85310/1BM	TERMOSTATICI ESTERNI	469,00	383	UP94108CR	UP	160,00	159
TG85310/1CR	TERMOSTATICI ESTERNI	313,00	383	UP94110/1BM	UP	695,00	157
TG85310/1IX	TERMOSTATICI ESTERNI	469,00	383	UP94110/1CR	UP	463,00	157
TG85310/30CR	COLONNE TERMOSTATICHE	939,00	394	UP94110BM	UP	784,00	157
TG85330BM	TERMOSTATICI ESTERNI	319,00	380	UP94110CR	UP	524,00	157
TG85330CR	TERMOSTATICI ESTERNI	213,00	380	UP94118/1BM	UP	368,00	155
TG85330IX	TERMOSTATICI ESTERNI	319,00	380	UP94118/1CR	UP	245,00	155
TG85430/20CR	COLONNE TERMOSTATICHE	524,00	395	UP94118/2BM	UP	362,00	155
TG85430/21BM	COLONNE TERMOSTATICHE	818,00	395	UP94118/2CR	UP	242,00	155
TG85430/21CR	COLONNE TERMOSTATICHE	545,00	395	UP94118/3BM	UP	389,00	155
TG85430/22CR	COLONNE TERMOSTATICHE	555,00	396	UP94118/3CR	UP	258,00	155
TH85530/54CR	COLONNE TERMOSTATICHE	859,00	389	UP94119/1BM	UP	368,00	157
TH85530/55CR	COLONNE TERMOSTATICHE	889,00	390	UP94119/1CR	UP	245,00	157
TH85530CR	TERMOSTATICI ESTERNI	221,00	377	UP94128/2BM	UP	575,00	155
TY85310/1CR	TERMOSTATICI ESTERNI	276,00	383	UP94128/2CR	UP	383,00	155
TY85330CR	TERMOSTATICI ESTERNI	181,00	381	UP94130/30BM	COLONNE MONOCOMANDO	1.160,00	404
TY85430/23CR	COLONNE TERMOSTATICHE	498,00	396	UP94130/30CR	COLONNE MONOCOMANDO	773,00	404
UP94010/1BM	UP	497,00	158	UP94130BM	UP	383,00	158
UP94010/1BM	TERMOSTATICI ESTERNI	497,00	382	UP94130CR	UP	255,00	158
UP94010/1CR	UP	331,00	158	UP94170BM	BORDO VASCA	365,00	517
UP94010/1CR	TERMOSTATICI ESTERNI	331,00	382	UP94170CR	BORDO VASCA	244,00	517
UP94010BM	UP	537,00	158	UP94198/1BM	UP	410,00	156
UP94010BM	TERMOSTATICI ESTERNI	537,00	385	UP94198/1BM	ALLBOX	410,00	294
UP94010CR	UP	359,00	158	UP94198/1CR	UP	272,00	156
UP94010CR	TERMOSTATICI ESTERNI	359,00	385	UP94198/1CR	ALLBOX	272,00	294
UP94030BM	UP	368,00	158	UP94198BM	UP	369,00	156
UP94030BM	TERMOSTATICI ESTERNI	368,00	379	UP94198BM	ALLBOX	369,00	294
UP94030CR	UP	245,00	158	UP94198CR	UP	246,00	156
UP94030CR	TERMOSTATICI ESTERNI	245,00	379	UP94198CR	ALLBOX	246,00	294
UP94100/EBM	UP	313,00	159	UP94204BM	BORDO VASCA	216,00	513
UP94100/EBM	EASYBOX	313,00	307	UP94204CR	BORDO VASCA	144,00	513
UP94100/ECR	UP	208,00	159	UP94713CR	CUCINA NOBILI	417,00	457
UP94100/ECR	EASYBOX	208,00	307	VE125010/1CGP	VELIS	978,00	54
UP94101BM	YOYO	570,00	119	VE125010/1CGP	TERMOSTATICI ESTERNI	978,00	381
UP94101BM	UP	570,00	161	VE125010/1CR	VELIS	611,00	54
UP94101BM	WELLBOX	570,00	320	VE125010/1CR	TERMOSTATICI ESTERNI	611,00	381
UP94101CR	YOYO	379,00	119	VE125010/1GUP	VELIS	978,00	54
UP94101CR	UP	379,00	161	VE125010/1GUP	TERMOSTATICI ESTERNI	978,00	381
UP94101CR	WELLBOX	379,00	320	VE125010/1IX	VELIS	918,00	54
UP94102BM	YOYO	570,00	119	VE125010/1IX	TERMOSTATICI ESTERNI	918,00	381
UP94102BM	UP	570,00	161	VE125010/1RCP	VELIS	978,00	54
UP94102BM	WELLBOX	570,00	324	VE125010/1RCP	TERMOSTATICI ESTERNI	978,00	381
UP94102CR	YOYO	379,00	119	VE125010/1RTP	VELIS	978,00	54
UP94102CR	UP	379,00	161	VE125010/1RTP	TERMOSTATICI ESTERNI	978,00	381
UP94102CR	WELLBOX	379,00	324	VE125010/1SB	VELIS	978,00	54
UP94103BM	YOYO	1.174,00	120	VE125010/1SB	TERMOSTATICI ESTERNI	978,00	381
UP94103BM	UP	1.174,00	162	VE125010/2CGP	VELIS	1.107,00	53
UP94103BM	WELLBOX	1.174,00	328	VE125010/2CGP	TERMOSTATICI ESTERNI	1.107,00	384
UP94103CR	YOYO	783,00	120	VE125010/2CR	VELIS	692,00	53
UP94103CR	UP	783,00	162	VE125010/2CR	TERMOSTATICI ESTERNI	692,00	384
UP94103CR	WELLBOX	783,00	328	VE125010/2GUP	VELIS	1.107,00	53
UP94104BM	YOYO	1.174,00	120	VE125010/2GUP	TERMOSTATICI ESTERNI	1.107,00	384
UP94104BM	UP	1.174,00	162	VE125010/2IX	VELIS	1.038,00	53
UP94104BM	WELLBOX	1.174,00	332	VE125010/2IX	TERMOSTATICI ESTERNI	1.038,00	384
UP94104CR	YOYO	783,00	120	VE125010/2RCP	VELIS	1.107,00	53

CODICE	COLLEZIONE	EURO	PAG.	CODICE	COLLEZIONE	EURO	PAG.
VE125010/2RCP	TERMOSTATICI ESTERNI	1.107,00	384	VE125110GUP	VELIS	629,00	53
VE125010/2RTP	VELIS	1.107,00	53	VE125110IX	VELIS	589,00	53
VE125010/2RTP	TERMOSTATICI ESTERNI	1.107,00	384	VE125110RCP	VELIS	629,00	53
VE125010/2SB	VELIS	1.107,00	53	VE125110RTP	VELIS	629,00	53
VE125010/2SB	TERMOSTATICI ESTERNI	1.107,00	384	VE125110SB	VELIS	629,00	53
VE125030/51BM	COLONNE TERMOSTATICHE	1.799,00	390	VE125118/2CGP	VELIS	563,00	43
VE125030/51CGP	COLONNE TERMOSTATICHE	1.918,00	390	VE125118/2CR	VELIS	352,00	43
VE125030/51CR	COLONNE TERMOSTATICHE	1.199,00	390	VE125118/2GUP	VELIS	563,00	43
VE125030/51GUP	COLONNE TERMOSTATICHE	1.918,00	390	VE125118/2IX	VELIS	528,00	43
VE125030/51IX	COLONNE TERMOSTATICHE	1.799,00	390	VE125118/2RCP	VELIS	563,00	43
VE125030/51RCP	COLONNE TERMOSTATICHE	1.918,00	390	VE125118/2RTP	VELIS	563,00	43
VE125030/51RTP	COLONNE TERMOSTATICHE	1.918,00	390	VE125118/2SB	VELIS	563,00	43
VE125030/51SB	COLONNE TERMOSTATICHE	1.918,00	390	VE125118/3CGP	VELIS	536,00	43
VE125030/51WM	COLONNE TERMOSTATICHE	1.799,00	390	VE125118/3CR	VELIS	335,00	43
VE125030CGP	VELIS	779,00	56	VE125118/3GUP	VELIS	536,00	43
VE125030CGP	TERMOSTATICI ESTERNI	779,00	377	VE125118/3IX	VELIS	503,00	43
VE125030CR	VELIS	487,00	56	VE125118/3RCP	VELIS	536,00	43
VE125030CR	TERMOSTATICI ESTERNI	487,00	377	VE125118/3RTP	VELIS	536,00	43
VE125030GUP	VELIS	779,00	56	VE125118/3SB	VELIS	536,00	43
VE125030GUP	TERMOSTATICI ESTERNI	779,00	377	VE125119/2CGP	VELIS	563,00	51
VE125030IX	VELIS	732,00	56	VE125119/2CR	VELIS	352,00	51
VE125030IX	TERMOSTATICI ESTERNI	732,00	377	VE125119/2GUP	VELIS	563,00	51
VE125030RCP	VELIS	779,00	56	VE125119/2IX	VELIS	528,00	51
VE125030RCP	TERMOSTATICI ESTERNI	779,00	377	VE125119/2RCP	VELIS	563,00	51
VE125030RTP	VELIS	779,00	56	VE125119/2RTP	VELIS	563,00	51
VE125030RTP	TERMOSTATICI ESTERNI	779,00	377	VE125119/2SB	VELIS	563,00	51
VE125030SB	VELIS	779,00	56	VE125119/3CGP	VELIS	536,00	51
VE125030SB	TERMOSTATICI ESTERNI	779,00	377	VE125119/3CR	VELIS	335,00	51
VE125100/ECGP	VELIS	370,00	56	VE125119/3GUP	VELIS	536,00	51
VE125100/ECGP	EASYBOX	370,00	305	VE125119/3IX	VELIS	503,00	51
VE125100/ECR	VELIS	230,00	56	VE125119/3RCP	VELIS	536,00	51
VE125100/ECR	EASYBOX	230,00	305	VE125119/3RTP	VELIS	536,00	51
VE125100/EGUP	VELIS	370,00	56	VE125119/3SB	VELIS	536,00	51
VE125100/EGUP	EASYBOX	370,00	305	VE125128/2CGP	VELIS	793,00	44
VE125100/EIX	VELIS	347,00	56	VE125128/2CR	VELIS	495,00	44
VE125100/EIX	EASYBOX	347,00	305	VE125128/2GUP	VELIS	793,00	44
VE125100/ERCPC	VELIS	370,00	56	VE125128/2IX	VELIS	743,00	44
VE125100/ERCPC	EASYBOX	370,00	305	VE125128/2RCP	VELIS	793,00	44
VE125100/ERTPC	VELIS	370,00	56	VE125128/2RTP	VELIS	793,00	44
VE125100/ERTPC	EASYBOX	370,00	305	VE125128/2SB	VELIS	793,00	44
VE125100/ESB	VELIS	370,00	56	VE125128/3CGP	VELIS	765,00	44
VE125100/ESB	EASYBOX	370,00	305	VE125128/3CR	VELIS	479,00	44
VE125108CGP	VELIS	386,00	56	VE125128/3GUP	VELIS	765,00	44
VE125108CR	VELIS	240,00	56	VE125128/3IX	VELIS	718,00	44
VE125108GUP	VELIS	386,00	56	VE125128/3RCP	VELIS	765,00	44
VE125108IX	VELIS	361,00	56	VE125128/3RTP	VELIS	765,00	44
VE125108RCP	VELIS	386,00	56	VE125128/3SB	VELIS	765,00	44
VE125108RTP	VELIS	386,00	56	VE125130CGP	VELIS	422,00	55
VE125108SB	VELIS	386,00	56	VE125130CR	VELIS	264,00	55
VE125110/1CGP	VELIS	589,00	53	VE125130GUP	VELIS	422,00	55
VE125110/1CR	VELIS	369,00	53	VE125130IX	VELIS	396,00	55
VE125110/1GUP	VELIS	589,00	53	VE125130RCP	VELIS	422,00	55
VE125110/1IX	VELIS	552,00	53	VE125130RTP	VELIS	422,00	55
VE125110/1RCP	VELIS	589,00	53	VE125130SB	VELIS	422,00	55
VE125110/1RTP	VELIS	589,00	53	VE125133CR	CUCINA NOBILI	369,00	451
VE125110/1SB	VELIS	589,00	53	VE125133IX	CUCINA NOBILI	552,00	451
VE125110CGP	VELIS	629,00	53	VE125134CR	CUCINA NOBILI	369,00	451
VE125110CR	VELIS	393,00	53	VE125134IX	CUCINA NOBILI	552,00	451

CODICE	COLLEZIONE	EURO	PAG.	CODICE	COLLEZIONE	EURO	PAG.
VE125138/2CGP	VELIS	563,00	45	VE125160GUP	VELIS	258,00	59
VE125138/2CR	VELIS	352,00	45	VE125160IX	VELIS	243,00	59
VE125138/2GUP	VELIS	563,00	45	VE125160RCP	VELIS	258,00	59
VE125138/2IX	VELIS	528,00	45	VE125160RTP	VELIS	258,00	59
VE125138/2RCP	VELIS	563,00	45	VE125160SB	VELIS	258,00	59
VE125138/2RTP	VELIS	563,00	45	VE125168/2CGP	VELIS	698,00	46
VE125138/2SB	VELIS	563,00	45	VE125168/2CR	VELIS	437,00	46
VE125138/3CGP	VELIS	536,00	45	VE125168/2GUP	VELIS	698,00	46
VE125138/3CR	VELIS	335,00	45	VE125168/2IX	VELIS	655,00	46
VE125138/3GUP	VELIS	536,00	45	VE125168/2RCP	VELIS	698,00	46
VE125138/3IX	VELIS	503,00	45	VE125168/2RTP	VELIS	698,00	46
VE125138/3RCP	VELIS	536,00	45	VE125168/2SB	VELIS	698,00	46
VE125138/3RTP	VELIS	536,00	45	VE125168/3CGP	VELIS	673,00	46
VE125138/3SB	VELIS	536,00	45	VE125168/3CR	VELIS	420,00	46
VE125139/2CGP	VELIS	563,00	51	VE125168/3GUP	VELIS	673,00	46
VE125139/2CR	VELIS	352,00	51	VE125168/3IX	VELIS	631,00	46
VE125139/2GUP	VELIS	563,00	51	VE125168/3RCP	VELIS	673,00	46
VE125139/2IX	VELIS	528,00	51	VE125168/3RTP	VELIS	673,00	46
VE125139/2RCP	VELIS	563,00	51	VE125168/3SB	VELIS	673,00	46
VE125139/2RTP	VELIS	563,00	51	VE125170CGP	BORDO VASCA	275,00	517
VE125139/2SB	VELIS	563,00	51	VE125170CR	BORDO VASCA	172,00	517
VE125139/3CGP	VELIS	536,00	51	VE125170GUP	BORDO VASCA	275,00	517
VE125139/3CR	VELIS	335,00	51	VE125170IX	BORDO VASCA	258,00	517
VE125139/3GUP	VELIS	536,00	51	VE125170RCP	BORDO VASCA	275,00	517
VE125139/3IX	VELIS	503,00	51	VE125170RTP	BORDO VASCA	275,00	517
VE125139/3RCP	VELIS	536,00	51	VE125170SB	BORDO VASCA	275,00	517
VE125139/3RTP	VELIS	536,00	51	VE125188/3CGP	VELIS	1.178,00	50
VE125139/3SB	VELIS	536,00	51	VE125188/3CR	VELIS	736,00	50
VE125148/2CGP	VELIS	793,00	46	VE125188/3GUP	VELIS	1.178,00	50
VE125148/2CR	VELIS	495,00	46	VE125188/3IX	VELIS	1.105,00	50
VE125148/2GUP	VELIS	793,00	46	VE125188/3RCP	VELIS	1.178,00	50
VE125148/2IX	VELIS	743,00	46	VE125188/3RTP	VELIS	1.178,00	50
VE125148/2RCP	VELIS	793,00	46	VE125188/3SB	VELIS	1.178,00	50
VE125148/2RTP	VELIS	793,00	46	VE125189/3CGP	VELIS	1.178,00	50
VE125148/2SB	VELIS	793,00	46	VE125189/3CR	VELIS	736,00	50
VE125148/3CGP	VELIS	765,00	46	VE125189/3GUP	VELIS	1.178,00	50
VE125148/3CR	VELIS	479,00	46	VE125189/3IX	VELIS	1.105,00	50
VE125148/3GUP	VELIS	765,00	46	VE125189/3RCP	VELIS	1.178,00	50
VE125148/3IX	VELIS	718,00	46	VE125189/3RTP	VELIS	1.178,00	50
VE125148/3RCP	VELIS	765,00	46	VE125189/3SB	VELIS	1.178,00	50
VE125148/3RTP	VELIS	765,00	46	VE125198/1CGP	VELIS	416,00	47
VE125148/3SB	VELIS	765,00	46	VE125198/1CGP	ALLBOX	416,00	287
VE125158/2CGP	VELIS	698,00	44	VE125198/1CR	VELIS	260,00	47
VE125158/2CR	VELIS	437,00	44	VE125198/1CR	ALLBOX	260,00	287
VE125158/2GUP	VELIS	698,00	44	VE125198/1GUP	VELIS	416,00	47
VE125158/2IX	VELIS	655,00	44	VE125198/1GUP	ALLBOX	416,00	287
VE125158/2RCP	VELIS	698,00	44	VE125198/1IX	VELIS	391,00	47
VE125158/2RTP	VELIS	698,00	44	VE125198/1IX	ALLBOX	391,00	287
VE125158/2SB	VELIS	698,00	44	VE125198/1RCP	VELIS	416,00	47
VE125158/3CGP	VELIS	673,00	44	VE125198/1RCP	ALLBOX	416,00	287
VE125158/3CR	VELIS	420,00	44	VE125198/1RTP	VELIS	416,00	47
VE125158/3GUP	VELIS	673,00	44	VE125198/1RTP	ALLBOX	416,00	287
VE125158/3IX	VELIS	631,00	44	VE125198/1SB	VELIS	416,00	47
VE125158/3RCP	VELIS	673,00	44	VE125198/1SB	ALLBOX	416,00	287
VE125158/3RTP	VELIS	673,00	44	VE125199/1CGP	VELIS	413,00	48
VE125158/3SB	VELIS	673,00	44	VE125199/1CGP	ALLBOX	413,00	287
VE125160CGP	VELIS	258,00	59	VE125199/1CR	VELIS	258,00	48
VE125160CR	VELIS	162,00	59	VE125199/1CR	ALLBOX	258,00	287

CODICE	COLLEZIONE	EURO	PAG.	CODICE	COLLEZIONE	EURO	PAG.
VEI25199/1GUP	VELIS	413,00	48	VEI25298/ESB	ALLBOX	551,00	301
VEI25199/1GUP	ALLBOX	413,00	287	VEK125208CGP	VELIS	269,00	59
VEI25199/1IX	VELIS	387,00	48	VEK125208CR	VELIS	168,00	59
VEI25199/1IX	ALLBOX	387,00	287	VEK125208GUP	VELIS	269,00	59
VEI25199/1RCP	VELIS	413,00	48	VEK125208IX	VELIS	252,00	59
VEI25199/1RCP	ALLBOX	413,00	287	VEK125208RCP	VELIS	269,00	59
VEI25199/1RTP	VELIS	413,00	48	VEK125208RTP	VELIS	269,00	59
VEI25199/1RTP	ALLBOX	413,00	287	VEK125208SB	VELIS	269,00	59
VEI25199/1SB	VELIS	413,00	48	VV103010/1BM	ACQUAVIVA	365,00	138
VEI25199/1SB	ALLBOX	413,00	287	VV103010/1BM	TERMOSTATICI ESTERNI	365,00	381
VEI25204CGP	BORDO VASCA	269,00	512	VV103010/1CR	ACQUAVIVA	244,00	138
VEI25204CR	BORDO VASCA	168,00	512	VV103010/1CR	TERMOSTATICI ESTERNI	244,00	381
VEI25204GUP	BORDO VASCA	269,00	512	VV103010BM	ACQUAVIVA	492,00	137
VEI25204IX	BORDO VASCA	252,00	512	VV103010BM	TERMOSTATICI ESTERNI	492,00	384
VEI25204RCP	BORDO VASCA	269,00	512	VV103010CR	ACQUAVIVA	329,00	137
VEI25204RTP	BORDO VASCA	269,00	512	VV103010CR	TERMOSTATICI ESTERNI	329,00	384
VEI25204SB	BORDO VASCA	269,00	512	VV103030BM	ACQUAVIVA	299,00	138
VEI25211/2CGP	VELIS	787,00	47	VV103030BM	TERMOSTATICI ESTERNI	299,00	379
VEI25211/2CR	VELIS	472,00	47	VV103030CR	ACQUAVIVA	200,00	138
VEI25211/2GUP	VELIS	787,00	47	VV103030CR	TERMOSTATICI ESTERNI	200,00	379
VEI25211/2IX	VELIS	709,00	47	VV103100/EBM	ACQUAVIVA	226,00	139
VEI25211/2RCP	VELIS	787,00	47	VV103100/EBM	EASYBOX	226,00	307
VEI25211/2RTP	VELIS	787,00	47	VV103100/ECR	ACQUAVIVA	151,00	139
VEI25211/2SB	VELIS	787,00	47	VV103100/ECR	EASYBOX	151,00	307
VEI25215/2CGP	VELIS	787,00	52	VV103108BM	ACQUAVIVA	149,00	139
VEI25215/2CR	VELIS	472,00	52	VV103108CR	ACQUAVIVA	100,00	139
VEI25215/2GUP	VELIS	787,00	52	VV103110/1BM	ACQUAVIVA	315,00	137
VEI25215/2IX	VELIS	709,00	52	VV103110/1CR	ACQUAVIVA	210,00	137
VEI25215/2RCP	VELIS	787,00	52	VV103110BM	ACQUAVIVA	442,00	137
VEI25215/2RTP	VELIS	787,00	52	VV103110CR	ACQUAVIVA	294,00	137
VEI25215/2SB	VELIS	787,00	52	VV103113CR	CUCINA NOBILI	207,00	457
VEI25298/1ECGP	VELIS	630,00	49	VV103118/1BM	ACQUAVIVA	236,00	135
VEI25298/1ECGP	ALLBOX	630,00	301	VV103118/1CR	ACQUAVIVA	158,00	135
VEI25298/1ECR	VELIS	332,00	49	VV103118/2BM	ACQUAVIVA	257,00	135
VEI25298/1ECR	ALLBOX	332,00	301	VV103118/2CR	ACQUAVIVA	171,00	135
VEI25298/1EGUP	VELIS	630,00	49	VV103118/3BM	ACQUAVIVA	232,00	135
VEI25298/1EGUP	ALLBOX	630,00	301	VV103118/3CR	ACQUAVIVA	154,00	135
VEI25298/1EIX	VELIS	498,00	49	VV103119/1BM	ACQUAVIVA	236,00	137
VEI25298/1EIX	ALLBOX	498,00	301	VV103119/1CR	ACQUAVIVA	158,00	137
VEI25298/1ERCP	VELIS	630,00	49	VV103127CR	CUCINA NOBILI	290,00	457
VEI25298/1ERCP	ALLBOX	630,00	301	VV103128/2BM	ACQUAVIVA	504,00	135
VEI25298/1ERTP	VELIS	630,00	49	VV103128/2CR	ACQUAVIVA	336,00	135
VEI25298/1ERTP	ALLBOX	630,00	301	VV103130BM	ACQUAVIVA	254,00	138
VEI25298/1ESB	VELIS	630,00	49	VV103130CR	ACQUAVIVA	169,00	138
VEI25298/1ESB	ALLBOX	630,00	301	VV103198/1BM	ACQUAVIVA	415,00	136
VEI25298/ECGP	VELIS	551,00	49	VV103198/1BM	ALLBOX	415,00	293
VEI25298/ECGP	ALLBOX	551,00	301	VV103198/1CR	ACQUAVIVA	277,00	136
VEI25298/ECR	VELIS	290,00	49	VV103198/1CR	ALLBOX	277,00	293
VEI25298/ECR	ALLBOX	290,00	301	VV103198BM	ACQUAVIVA	375,00	136
VEI25298/EGUP	VELIS	551,00	49	VV103198BM	ALLBOX	375,00	292
VEI25298/EGUP	ALLBOX	551,00	301	VV103198CR	ACQUAVIVA	250,00	136
VEI25298/EIX	VELIS	435,00	49	VV103198CR	ALLBOX	250,00	292
VEI25298/EIX	ALLBOX	435,00	301	WB00113CR	CUCINA NOBILI	261,00	447
VEI25298/ERCP	VELIS	551,00	49	WB00117/2CR	CUCINA NOBILI	402,00	447
VEI25298/ERCP	ALLBOX	551,00	301	WB00123CR	CUCINA NOBILI	236,00	447
VEI25298/ERTP	VELIS	551,00	49	WB00127CR	CUCINA NOBILI	320,00	447
VEI25298/ERTP	ALLBOX	551,00	301	WE00101	SOLE	167,00	37
VEI25298/ESB	VELIS	551,00	49	WE00101	VELIS	167,00	59

CODICE	COLLEZIONE	EURO	PAG.	CODICE	COLLEZIONE	EURO	PAG.
WE00101	DRESS	167,00	70	WE00102	SOFI	215,00	193
WE00101	LIKID	167,00	77	WE00102	LIRA	215,00	203
WE00101	LIVE	167,00	93	WE00102	CARLOS PRIMERO	215,00	211
WE00101	YOYO	167,00	119	WE00102	GRAZIA	215,00	219
WE00101	SEVEN	167,00	130	WE00102	WELLBOX	215,00	323
WE00101	LOOP	167,00	151	WE00102/QBM	SEVEN	779,00	131
WE00101	UP	167,00	161	WE00102/QBM	MIA	779,00	184
WE00101	RAY	167,00	171	WE00102/QBM	WELLBOX	779,00	324
WE00101	MIA	167,00	183	WE00102/QCR	SEVEN	519,00	131
WE00101	SOFI	167,00	192	WE00102/QCR	RAY	519,00	172
WE00101	LIRA	167,00	203	WE00102/QCR	MIA	519,00	184
WE00101	CARLOS PRIMERO	167,00	210	WE00102/QCR	WELLBOX	519,00	324
WE00101	GRAZIA	167,00	219	WE00102/QIX	SEVEN	779,00	131
WE00101	WELLBOX	167,00	319	WE00102/QIX	MIA	779,00	184
WE00101/QBM	SEVEN	779,00	130	WE00102/QIX	WELLBOX	779,00	324
WE00101/QBM	MIA	779,00	183	WE00102/TBM	LIVE	621,00	93
WE00101/QBM	WELLBOX	779,00	320	WE00102/TBM	WELLBOX	621,00	323
WE00101/QCR	SEVEN	519,00	130	WE00102/TCGP	VELIS	662,00	60
WE00101/QCR	RAY	519,00	171	WE00102/TCGP	LIVE	662,00	93
WE00101/QCR	MIA	519,00	183	WE00102/TCGP	WELLBOX	662,00	323
WE00101/QCR	WELLBOX	519,00	320	WE00102/TCR	VELIS	414,00	60
WE00101/QIX	SEVEN	779,00	130	WE00102/TCR	LIVE	414,00	93
WE00101/QIX	MIA	779,00	183	WE00102/TCR	WELLBOX	414,00	323
WE00101/QIX	WELLBOX	779,00	320	WE00102/TGUP	VELIS	662,00	60
WE00101/TBM	LIVE	621,00	93	WE00102/TGUP	LIVE	662,00	93
WE00101/TBM	WELLBOX	621,00	319	WE00102/TGUP	WELLBOX	662,00	323
WE00101/TCGP	VELIS	662,00	59	WE00102/TIX	VELIS	621,00	60
WE00101/TCGP	LIVE	662,00	93	WE00102/TIX	LIVE	621,00	93
WE00101/TCGP	WELLBOX	662,00	319	WE00102/TIX	WELLBOX	621,00	323
WE00101/TCR	VELIS	414,00	59	WE00102/TRCP	VELIS	662,00	60
WE00101/TCR	LIVE	414,00	93	WE00102/TRCP	WELLBOX	662,00	323
WE00101/TCR	WELLBOX	414,00	319	WE00102/TRTP	VELIS	662,00	60
WE00101/TGUP	VELIS	662,00	59	WE00102/TRTP	LIVE	662,00	93
WE00101/TGUP	LIVE	662,00	93	WE00102/TRTP	WELLBOX	662,00	323
WE00101/TGUP	WELLBOX	662,00	319	WE00102/TSB	VELIS	662,00	60
WE00101/TIX	VELIS	621,00	59	WE00102/TSB	WELLBOX	662,00	323
WE00101/TIX	LIVE	621,00	93	WE00102/TWM	LIVE	621,00	93
WE00101/TIX	WELLBOX	621,00	319	WE00102/TWM	WELLBOX	621,00	323
WE00101/TRCP	VELIS	662,00	59	WE00103	SOLE	318,00	38
WE00101/TRCP	WELLBOX	662,00	319	WE00103	VELIS	318,00	60
WE00101/TRTP	VELIS	662,00	59	WE00103	DRESS	318,00	71
WE00101/TRTP	LIVE	662,00	93	WE00103	LIKID	318,00	78
WE00101/TRTP	WELLBOX	662,00	319	WE00103	LIVE	318,00	94
WE00101/TSB	VELIS	662,00	59	WE00103	YOYO	318,00	120
WE00101/TSB	WELLBOX	662,00	319	WE00103	SEVEN	318,00	131
WE00101/TWM	LIVE	621,00	93	WE00103	LOOP	318,00	152
WE00101/TWM	WELLBOX	621,00	319	WE00103	UP	318,00	162
WE00102	SOLE	215,00	37	WE00103	RAY	318,00	172
WE00102	VELIS	215,00	60	WE00103	MIA	318,00	184
WE00102	DRESS	215,00	70	WE00103	SOFI	318,00	193
WE00102	LIKID	215,00	77	WE00103	LIRA	318,00	204
WE00102	LIVE	215,00	93	WE00103	CARLOS PRIMERO	318,00	211
WE00102	YOYO	215,00	119	WE00103	GRAZIA	318,00	220
WE00102	SEVEN	215,00	131	WE00103	WELLBOX	318,00	327
WE00102	LOOP	215,00	152	WE00103/QBM	SEVEN	1.447,00	131
WE00102	UP	215,00	161	WE00103/QBM	MIA	1.447,00	184
WE00102	RAY	215,00	172	WE00103/QBM	WELLBOX	1.447,00	328
WE00102	MIA	215,00	184	WE00103/QCR	SEVEN	965,00	131

CODICE	COLLEZIONE	EURO	PAG.	CODICE	COLLEZIONE	EURO	PAG.
WE00103/QCR	RAY	965,00	172	WE00104/TCGP	LIVE	1.368,00	94
WE00103/QCR	MIA	965,00	184	WE00104/TCGP	WELLBOX	1.368,00	331
WE00103/QCR	WELLBOX	965,00	328	WE00104/TCR	VELIS	856,00	61
WE00103/QIX	SEVEN	1.447,00	131	WE00104/TCR	LIVE	856,00	94
WE00103/QIX	MIA	1.447,00	184	WE00104/TCR	WELLBOX	856,00	331
WE00103/QIX	WELLBOX	1.447,00	328	WE00104/TGUP	VELIS	1.368,00	61
WE00103/TBM	LIVE	1.283,00	94	WE00104/TGUP	LIVE	1.368,00	94
WE00103/TBM	WELLBOX	1.283,00	327	WE00104/TGUP	WELLBOX	1.368,00	331
WE00103/TCGP	VELIS	1.368,00	60	WE00104/TIX	VELIS	1.283,00	61
WE00103/TCGP	LIVE	1.368,00	94	WE00104/TIX	LIVE	1.283,00	94
WE00103/TCGP	WELLBOX	1.368,00	327	WE00104/TIX	WELLBOX	1.283,00	331
WE00103/TCR	VELIS	856,00	60	WE00104/TRCP	VELIS	1.368,00	61
WE00103/TCR	LIVE	856,00	94	WE00104/TRCP	WELLBOX	1.368,00	331
WE00103/TCR	WELLBOX	856,00	327	WE00104/TRTP	VELIS	1.368,00	61
WE00103/TGUP	VELIS	1.368,00	60	WE00104/TRTP	LIVE	1.368,00	94
WE00103/TGUP	LIVE	1.368,00	94	WE00104/TRTP	WELLBOX	1.368,00	331
WE00103/TGUP	WELLBOX	1.368,00	327	WE00104/TSB	VELIS	1.368,00	61
WE00103/TIX	VELIS	1.283,00	60	WE00104/TSB	WELLBOX	1.368,00	331
WE00103/TIX	LIVE	1.283,00	94	WE00104/TWM	LIVE	1.283,00	94
WE00103/TIX	WELLBOX	1.283,00	327	WE00104/TWM	WELLBOX	1.283,00	331
WE00103/TRCP	VELIS	1.368,00	60	WE00110/9QBM	BORDO VASCA	517,00	512
WE00103/TRCP	WELLBOX	1.368,00	327	WE00110/9QCR	BORDO VASCA	345,00	512
WE00103/TRTP	VELIS	1.368,00	60	WE00110/9QIX	BORDO VASCA	517,00	512
WE00103/TRTP	LIVE	1.368,00	94	WE00110/9SOCR	BORDO VASCA	262,00	511
WE00103/TRTP	WELLBOX	1.368,00	327	WE00110/9SOGUP	BORDO VASCA	419,00	511
WE00103/TSB	VELIS	1.368,00	60	WE00110/9SOIX	BORDO VASCA	393,00	511
WE00103/TSB	WELLBOX	1.368,00	327	WE00110/9SORTP	BORDO VASCA	419,00	511
WE00103/TWM	LIVE	1.283,00	94	WE00110/9SOSB	BORDO VASCA	419,00	511
WE00103/TWM	WELLBOX	1.283,00	327	WE00110/9TBM	BORDO VASCA	333,00	511
WE00104	SOLE	360,00	38	WE00110/9TCR	BORDO VASCA	223,00	511
WE00104	VELIS	360,00	61	WE00110/9TIX	BORDO VASCA	333,00	511
WE00104	DRESS	360,00	71	WE00110/9TWM	BORDO VASCA	333,00	511
WE00104	LIKID	360,00	78	WE00110/9VECGP	BORDO VASCA	265,00	511
WE00104	LIVE	360,00	94	WE00110/9VECR	BORDO VASCA	166,00	511
WE00104	YOYO	360,00	120	WE00110/9VEGUP	BORDO VASCA	265,00	511
WE00104	SEVEN	360,00	132	WE00110/9VEIX	BORDO VASCA	249,00	511
WE00104	LOOP	360,00	153	WE00110/9VERCP	BORDO VASCA	265,00	511
WE00104	UP	360,00	162	WE00110/9VERTP	BORDO VASCA	265,00	511
WE00104	RAY	360,00	173	WE00110/9VESB	BORDO VASCA	265,00	511
WE00104	MIA	360,00	185	WE00139/24CGP	COMPONENTI DOCCIA	331,00	356
WE00104	SOFI	360,00	194	WE00139/24CR	COMPONENTI DOCCIA	207,00	356
WE00104	LIRA	360,00	204	WE00139/24SB	COMPONENTI DOCCIA	331,00	356
WE00104	CARLOS PRIMERO	360,00	212	WE00139/80CR	COMPONENTI DOCCIA	158,00	355
WE00104	GRAZIA	360,00	220	WE00139/81BM	COMPONENTI DOCCIA	236,00	354
WE00104	WELLBOX	360,00	331	WE00139/81CGP	VELIS	251,00	62
WE00104/QBM	SEVEN	1.447,00	132	WE00139/81CGP	COMPONENTI DOCCIA	251,00	354
WE00104/QBM	MIA	1.447,00	185	WE00139/81CR	SOLE	158,00	40
WE00104/QBM	WELLBOX	1.447,00	332	WE00139/81CR	VELIS	158,00	62
WE00104/QCR	SEVEN	965,00	132	WE00139/81CR	COMPONENTI DOCCIA	158,00	354
WE00104/QCR	RAY	965,00	173	WE00139/81GUP	SOLE	251,00	40
WE00104/QCR	MIA	965,00	185	WE00139/81GUP	VELIS	251,00	62
WE00104/QCR	WELLBOX	965,00	332	WE00139/81GUP	COMPONENTI DOCCIA	251,00	354
WE00104/QIX	SEVEN	1.447,00	132	WE00139/81IX	SOLE	236,00	40
WE00104/QIX	MIA	1.447,00	185	WE00139/81IX	VELIS	236,00	62
WE00104/QIX	WELLBOX	1.447,00	332	WE00139/81IX	COMPONENTI DOCCIA	236,00	354
WE00104/TBM	LIVE	1.283,00	94	WE00139/81RCP	VELIS	251,00	62
WE00104/TBM	WELLBOX	1.283,00	331	WE00139/81RCP	COMPONENTI DOCCIA	251,00	354
WE00104/TCGP	VELIS	1.368,00	61	WE00139/81RTP	SOLE	251,00	40

CODICE	COLLEZIONE	EURO	PAG.	CODICE	COLLEZIONE	EURO	PAG.
WE00139/81RTP	VELIS	251,00	62	WE00180/VERTP	VELIS	2.200,00	52
WE00139/81RTP	COMPONENTI DOCCIA	251,00	354	WE00180/VESB	VELIS	2.200,00	52
WE00139/81SB	SOLE	251,00	40	WE00198	DRESS	125,00	66
WE00139/81SB	VELIS	251,00	62	WE00198	LIVE	125,00	83
WE00139/81SB	COMPONENTI DOCCIA	251,00	354	WE00198	LIVE	125,00	84
WE00139/81WM	COMPONENTI DOCCIA	236,00	354	WE00198	LIVE	125,00	85
WE00139/82BM	COMPONENTI DOCCIA	236,00	355	WE00198	UNO	125,00	105
WE00139/82CR	COMPONENTI DOCCIA	158,00	355	WE00198	YOYO	125,00	115
WE00139/82IX	COMPONENTI DOCCIA	236,00	355	WE00198	YOYO	125,00	116
WE00139/85CR	COMPONENTI DOCCIA	144,00	355	WE00198	SEVEN	125,00	125
WE00139/86CR	COMPONENTI DOCCIA	141,00	355	WE00198	ACQUAVIVA	125,00	136
WE00139/87CR	COMPONENTI DOCCIA	141,00	354	WE00198	LOOP	125,00	144
WE00139/94CR	COMPONENTI DOCCIA	99,00	345	WE00198	LOOP	125,00	145
WE00141/40CR	RENOVA	465,00	411	WE00198	UP	125,00	156
WE00141/50CR	RENOVA	531,00	411	WE00198	RAY	125,00	166
WE00141/70CR	RENOVA	597,00	412	WE00198	MIA	125,00	176
WE00141/75CR	RENOVA	664,00	412	WE00198	MIA	125,00	177
WE00141/82CR	RENOVA	677,00	413	WE00198	SOFI	125,00	188
WE00141/85CR	RENOVA	685,00	414	WE00198	ABC	125,00	232
WE00141/90CR	RENOVA	438,00	413	WE00198	ABC	125,00	233
WE00141/95CR	RENOVA	505,00	414	WE00198	SKY	125,00	248
WE00170/QBM	BORDO VASCA	400,00	518	WE00198	SKY	125,00	249
WE00170/QCR	BORDO VASCA	267,00	518	WE00198	NEW ROAD	125,00	257
WE00170/QIX	BORDO VASCA	400,00	518	WE00198	NEW ROAD	125,00	258
WE00170/TBM	BORDO VASCA	365,00	517	WE00198	NEW ROAD	125,00	259
WE00170/TCR	BORDO VASCA	244,00	517	WE00198	ALLBOX	125,00	289
WE00170/TIX	BORDO VASCA	365,00	517	WE00202	ONOFF	110,00	335
WE00170/TWM	BORDO VASCA	365,00	517	WE00202/EBCR	ONOFF	835,00	335
WE00171/SOCR	BORDO VASCA	265,00	516	WE00202/ECR	ONOFF	712,00	335
WE00171/SOGUP	BORDO VASCA	424,00	516	WE00202/EWCR	ONOFF	835,00	335
WE00171/SOIX	BORDO VASCA	398,00	516	WE00204/QBM	BORDO VASCA	282,00	513
WE00171/SORTP	BORDO VASCA	424,00	516	WE00204/QCR	BORDO VASCA	188,00	513
WE00171/SOSB	BORDO VASCA	424,00	516	WE00204/QIX	BORDO VASCA	282,00	513
WE00171/TCGP	BORDO VASCA	269,00	517	WE00204/TBM	BORDO VASCA	216,00	512
WE00171/TCR	BORDO VASCA	168,00	517	WE00204/TCR	BORDO VASCA	144,00	512
WE00171/TGUP	BORDO VASCA	269,00	517	WE00204/TIX	BORDO VASCA	216,00	512
WE00171/TIX	BORDO VASCA	252,00	517	WE00204/TWM	BORDO VASCA	216,00	512
WE00171/TRCP	BORDO VASCA	269,00	517	WE00298	SOLE	130,00	31
WE00171/TRTP	BORDO VASCA	269,00	517	WE00298	VELIS	130,00	49
WE00171/TSB	BORDO VASCA	269,00	517	WE00298	UNO	130,00	106
WE00180/QBM	MIA	2.498,00	178	WE00298	LIRA	130,00	199
WE00180/QCR	MIA	1.665,00	178	WE00298	CARLOS PRIMERO	130,00	208
WE00180/QIX	MIA	2.498,00	178	WE00298	ALLBOX	130,00	301
WE00180/SEBM	SEVEN	2.281,00	126	WE00318	SOLE	320,00	32
WE00180/SECR	SEVEN	1.555,00	126	WE00600	SOLE	104,00	30
WE00180/SEIX	SEVEN	2.281,00	126	WE00600	VELIS	104,00	47
WE00180/TBM	LIVE	2.062,00	86	WE00600	VELIS	104,00	48
WE00180/TCGP	LIVE	2.197,00	86	WE00600	ALLBOX	104,00	287
WE00180/TCR	LIVE	1.373,00	86	WE72200/10CR	COLONNE TERMOSTATICHE	3.990,00	397
WE00180/TGUP	LIVE	2.197,00	86	WE72200/20CR	COLONNE TERMOSTATICHE	4.164,00	398
WE00180/TIX	LIVE	2.062,00	86	WE77250	SOLE	291,00	31
WE00180/TRTP	LIVE	2.197,00	86	WE77250	VELIS	291,00	50
WE00180/TWM	LIVE	2.062,00	86	WE77250	VELIS	291,00	52
WE00180/VECGP	VELIS	2.200,00	52	WE77250	LIVE	291,00	86
WE00180/VECR	VELIS	1.373,00	52	WE77250	SEVEN	291,00	126
WE00180/VEGUP	VELIS	2.200,00	52	WE77250	LOOP	291,00	146
WE00180/VEIX	VELIS	2.062,00	52	WE77250	MIA	291,00	178
WE00180/VERCP	VELIS	2.200,00	52	WE81100	VELIS	135,00	56

CODICE	COLLEZIONE	EURO	PAG.	CODICE	COLLEZIONE	EURO	PAG.
WE81100	DRESS	135,00	68	WE81102/DSC08	TECHBOX	589,00	315
WE81100	LIVE	135,00	90	WE81102/DSC09	DRESS	759,00	69
WE81100	ACQUERELLI	135,00	100	WE81102/DSC09	TECHBOX	759,00	311
WE81100	UNO	135,00	109	WE81102/DSC09	TECHBOX	759,00	315
WE81100	YOYO	135,00	118	WE81102/DSC10	DRESS	759,00	69
WE81100	SEVEN	135,00	129	WE81102/DSC10	TECHBOX	759,00	311
WE81100	ACQUAVIVA	135,00	139	WE81102/DSC10	TECHBOX	759,00	315
WE81100	LOOP	135,00	149	WE81102/DSC11	DRESS	759,00	69
WE81100	UP	135,00	159	WE81102/DSC11	TECHBOX	759,00	311
WE81100	RAY	135,00	169	WE81102/DSC11	TECHBOX	759,00	315
WE81100	MIA	135,00	181	WE81102/DSC12	DRESS	759,00	69
WE81100	SOFI	135,00	191	WE81102/DSC12	TECHBOX	759,00	311
WE81100	EASYBOX	135,00	305	WE81102/DSC12	TECHBOX	759,00	315
WE81100/SC	BLUES	67,00	226	WE81102/DSC14	DRESS	931,00	69
WE81100/SC	ABC	67,00	237	WE81102/DSC14	TECHBOX	931,00	311
WE81100/SC	NOBI	67,00	241	WE81102/DSC14	TECHBOX	931,00	315
WE81100/SC	SAND	67,00	245	WE81102/DSC16	DRESS	931,00	69
WE81100/SC	SKY	67,00	252	WE81102/DSC16	TECHBOX	931,00	311
WE81100/SC	NEW ROAD	67,00	262	WE81102/DSC16	TECHBOX	931,00	315
WE81102	SOLE	160,00	35	WE81102/DSC17	DRESS	1.729,00	69
WE81102	VELIS	160,00	57	WE81102/DSC17	TECHBOX	1.729,00	311
WE81102	DRESS	160,00	69	WE81102/DSC17	TECHBOX	1.729,00	315
WE81102	LIVE	160,00	91	WE81102/DSC19	DRESS	1.729,00	69
WE81102	ACQUERELLI	160,00	101	WE81102/DSC19	TECHBOX	1.729,00	311
WE81102	UNO	160,00	110	WE81102/DSC19	TECHBOX	1.729,00	315
WE81102	SEVEN	160,00	129	WE81102/DSC21	DRESS	1.429,00	69
WE81102	LOOP	160,00	150	WE81102/DSC21	TECHBOX	1.429,00	311
WE81102	UP	160,00	160	WE81102/DSC21	TECHBOX	1.429,00	315
WE81102	RAY	160,00	170	WE81102/DST22	DRESS	1.429,00	69
WE81102	MIA	160,00	182	WE81102/DST22	TECHBOX	1.429,00	311
WE81102	SOFI	160,00	191	WE81102/DST22	TECHBOX	1.429,00	315
WE81102	TECHBOX	160,00	311	WE81102/DSTBK	DRESS	931,00	69
WE81102/ISOCR	SOLE	410,00	35	WE81102/DSTBK	TECHBOX	931,00	311
WE81102/ISOCR	TECHBOX	410,00	311	WE81102/DSTBK	TECHBOX	931,00	315
WE81102/ISOCR	TECHBOX	410,00	315	WE81102/DSTNI	DRESS	931,00	69
WE81102/ISOGUP	SOLE	656,00	35	WE81102/DSTNI	TECHBOX	931,00	311
WE81102/ISOGUP	TECHBOX	656,00	311	WE81102/DSTNI	TECHBOX	931,00	315
WE81102/ISOGUP	TECHBOX	656,00	315	WE81102/LPCR	LOOP	430,00	150
WE81102/ISOIX	SOLE	615,00	35	WE81102/LPCR	TECHBOX	430,00	312
WE81102/ISOIX	TECHBOX	615,00	311	WE81102/LPCR	TECHBOX	430,00	316
WE81102/ISOIX	TECHBOX	615,00	315	WE81102/LRBM	UNO	618,00	110
WE81102/ISORTP	SOLE	656,00	35	WE81102/LRBM	TECHBOX	618,00	312
WE81102/ISORTP	TECHBOX	656,00	311	WE81102/LRBM	TECHBOX	618,00	316
WE81102/ISORTP	TECHBOX	656,00	315	WE81102/LRCR	UNO	413,00	110
WE81102/ISOSB	SOLE	656,00	35	WE81102/LRCR	TECHBOX	413,00	312
WE81102/ISOSB	TECHBOX	656,00	311	WE81102/LRCR	TECHBOX	413,00	316
WE81102/ISOSB	TECHBOX	656,00	315	WE81102/QBM	MIA	630,00	182
WE81102/DSC01	DRESS	589,00	69	WE81102/QBM	TECHBOX	630,00	313
WE81102/DSC01	TECHBOX	589,00	311	WE81102/QBM	TECHBOX	630,00	317
WE81102/DSC01	TECHBOX	589,00	315	WE81102/QCR	RAY	420,00	170
WE81102/DSC02	DRESS	589,00	69	WE81102/QCR	MIA	420,00	182
WE81102/DSC02	TECHBOX	589,00	311	WE81102/QCR	TECHBOX	420,00	313
WE81102/DSC02	TECHBOX	589,00	315	WE81102/QCR	TECHBOX	420,00	317
WE81102/DSC07	DRESS	589,00	69	WE81102/QIX	MIA	630,00	182
WE81102/DSC07	TECHBOX	589,00	311	WE81102/QIX	TECHBOX	630,00	313
WE81102/DSC07	TECHBOX	589,00	315	WE81102/QIX	TECHBOX	630,00	317
WE81102/DSC08	DRESS	589,00	69	WE81102/SEBM	SEVEN	597,00	129
WE81102/DSC08	TECHBOX	589,00	311	WE81102/SEBM	SEVEN	597,00	130



CODICE	COLLEZIONE	EURO	PAG.	CODICE	COLLEZIONE	EURO	PAG.
WE81102/SEBM	TECHBOX	597,00	312	WE81102/VEIX	TECHBOX	618,00	311
WE81102/SEBM	TECHBOX	597,00	316	WE81102/VEIX	TECHBOX	618,00	315
WE81102/SECR	SEVEN	398,00	129	WE81102/VERCP	VELIS	660,00	57
WE81102/SECR	SEVEN	398,00	130	WE81102/VERCP	TECHBOX	660,00	311
WE81102/SECR	TECHBOX	398,00	312	WE81102/VERCP	TECHBOX	660,00	315
WE81102/SECR	TECHBOX	398,00	316	WE81102/VERTP	VELIS	660,00	57
WE81102/SEIX	SEVEN	597,00	129	WE81102/VERTP	TECHBOX	660,00	311
WE81102/SEIX	SEVEN	597,00	130	WE81102/VERTP	TECHBOX	660,00	315
WE81102/SEIX	TECHBOX	597,00	312	WE81102/VESB	VELIS	660,00	57
WE81102/SEIX	TECHBOX	597,00	316	WE81102/VESB	TECHBOX	660,00	311
WE81102/SICR	SOFI	415,00	191	WE81102/VESB	TECHBOX	660,00	315
WE81102/SICR	SOFI	415,00	192	WE81103	SOLE	184,00	35
WE81102/SICR	TECHBOX	415,00	313	WE81103	VELIS	184,00	57
WE81102/SICR	TECHBOX	415,00	317	WE81103	DRESS	184,00	69
WE81102/SISB	SOFI	664,00	191	WE81103	LIVE	184,00	91
WE81102/SISB	SOFI	664,00	192	WE81103	ACQUERELLI	184,00	101
WE81102/SISB	TECHBOX	664,00	313	WE81103	UNO	184,00	110
WE81102/SISB	TECHBOX	664,00	317	WE81103	SEVEN	184,00	130
WE81102/TBM	LIVE	618,00	91	WE81103	LOOP	184,00	150
WE81102/TBM	ACQUERELLI	618,00	101	WE81103	UP	184,00	160
WE81102/TBM	TECHBOX	618,00	312	WE81103	RAY	184,00	170
WE81102/TBM	TECHBOX	618,00	316	WE81103	MIA	184,00	182
WE81102/TCGP	LIVE	661,00	91	WE81103	SOFI	184,00	192
WE81102/TCGP	TECHBOX	661,00	312	WE81103	TECHBOX	184,00	315
WE81102/TCGP	TECHBOX	661,00	316	WE81200/LPCR	LOOP	390,00	151
WE81102/TCR	LIVE	413,00	91	WE81200/QBM	MIA	585,00	183
WE81102/TCR	ACQUERELLI	413,00	101	WE81200/QCR	RAY	390,00	171
WE81102/TCR	TECHBOX	413,00	312	WE81200/QCR	MIA	390,00	183
WE81102/TCR	TECHBOX	413,00	316	WE81200/QIX	MIA	585,00	183
WE81102/TGUP	LIVE	661,00	91	WE81200/T	SOLE	334,00	36
WE81102/TGUP	TECHBOX	661,00	312	WE81200/T	VELIS	334,00	58
WE81102/TGUP	TECHBOX	661,00	316	WE81200/T	LIVE	334,00	92
WE81102/TIX	LIVE	618,00	91	WE81201/LPCR	LOOP	442,00	148
WE81102/TIX	ACQUERELLI	618,00	101	WE81201/QBM	MIA	663,00	180
WE81102/TIX	TECHBOX	618,00	312	WE81201/QCR	MIA	442,00	180
WE81102/TIX	TECHBOX	618,00	316	WE81201/QIX	MIA	663,00	180
WE81102/TRTP	LIVE	661,00	91	WE81201/T	SOLE	390,00	34
WE81102/TRTP	TECHBOX	661,00	312	WE81201/T	VELIS	390,00	54
WE81102/TRTP	TECHBOX	661,00	316	WE81201/T	VELIS	390,00	55
WE81102/TWM	LIVE	618,00	91	WE81201/T	LIVE	390,00	88
WE81102/TWM	TECHBOX	618,00	312	WE81201/T	LIVE	390,00	89
WE81102/TWM	TECHBOX	618,00	316	WEBK110/6ABBM	ABC	639,00	235
WE81102/UPBM	UP	615,00	160	WEBK110/6ABCR	ABC	473,00	235
WE81102/UPBM	TECHBOX	615,00	313	WEBK110/6SEBM	SEVEN	1.372,00	127
WE81102/UPBM	TECHBOX	615,00	317	WEBK110/6SECR	SEVEN	980,00	127
WE81102/UPCR	UP	410,00	160	WEBK110/6SEIX	SEVEN	1.372,00	127
WE81102/UPCR	TECHBOX	410,00	313	WEBK110/90LPCR	LOOP	676,00	148
WE81102/UPCR	TECHBOX	410,00	317	WEBK110/90QBM	MIA	1.148,00	180
WE81102/VECGP	VELIS	660,00	57	WEBK110/90QCR	MIA	764,00	180
WE81102/VECGP	TECHBOX	660,00	311	WEBK110/90QIX	MIA	1.148,00	180
WE81102/VECGP	TECHBOX	660,00	315	WEBK110/90TBM	LIVE	784,00	89
WE81102/VECR	VELIS	413,00	57	WEBK110/90TCGP	LIVE	838,00	89
WE81102/VECR	TECHBOX	413,00	311	WEBK110/90TCR	LIVE	524,00	89
WE81102/VECR	TECHBOX	413,00	315	WEBK110/90TGUP	LIVE	838,00	89
WE81102/VEGUP	VELIS	660,00	57	WEBK110/90TIX	LIVE	784,00	89
WE81102/VEGUP	TECHBOX	660,00	311	WEBK110/90TRTP	LIVE	838,00	89
WE81102/VEGUP	TECHBOX	660,00	315	WEBK110/90TWM	LIVE	784,00	89
WE81102/VEIX	VELIS	618,00	57	WEBK110/90VECGP	VELIS	837,00	55

CODICE	COLLEZIONE	EURO	PAG.	CODICE	COLLEZIONE	EURO	PAG.
WEBK110/90VECR	VELIS	524,00	55	WEBK204/DSC01	DRESS	1.607,00	67
WEBK110/90VEGUP	VELIS	837,00	55	WEBK204/DSC02	DRESS	1.607,00	67
WEBK110/90VEIX	VELIS	784,00	55	WEBK204/DSC07	DRESS	1.607,00	67
WEBK110/90VERCP	VELIS	837,00	55	WEBK204/DSC08	DRESS	1.607,00	67
WEBK110/90VERTP	VELIS	837,00	55	WEBK204/DSC09	DRESS	2.087,00	67
WEBK110/90VESB	VELIS	837,00	55	WEBK204/DSC10	DRESS	2.087,00	67
WEBK110/91SOCCR	SOLE	610,00	34	WEBK204/DSC11	DRESS	2.087,00	67
WEBK110/91SOGUP	SOLE	976,00	34	WEBK204/DSC12	DRESS	2.087,00	67
WEBK110/91SOIX	SOLE	915,00	34	WEBK204/DSC14	DRESS	2.570,00	67
WEBK110/91SORTP	SOLE	976,00	34	WEBK204/DSC16	DRESS	2.570,00	67
WEBK110/91SOSB	SOLE	976,00	34	WEBK204/DSC17	DRESS	4.816,00	67
WEBK110/91TBM	LIVE	784,00	88	WEBK204/DSC19	DRESS	4.816,00	67
WEBK110/91TCGP	LIVE	838,00	88	WEBK204/DSC21	DRESS	3.795,00	67
WEBK110/91TCR	LIVE	524,00	88	WEBK204/DST22	DRESS	3.795,00	67
WEBK110/91TGUP	LIVE	838,00	88	WEBK204/DSTBK	DRESS	2.570,00	67
WEBK110/91TIX	LIVE	784,00	88	WEBK204/DSTNI	DRESS	2.570,00	67
WEBK110/91TRTP	LIVE	838,00	88	WEBK204/GRCGP	GRAZIA	1.451,00	217
WEBK110/91TWM	LIVE	784,00	88	WEBK204/GRCR	GRAZIA	907,00	217
WEBK110/91VECGP	VELIS	837,00	54	WEBK204/LPCR	LOOP	1.377,00	147
WEBK110/91VECR	VELIS	524,00	54	WEBK204/LRBM	LIRA	1.130,00	201
WEBK110/91VEGUP	VELIS	837,00	54	WEBK204/LRCR	LIRA	754,00	201
WEBK110/91VEIX	VELIS	784,00	54	WEBK204/LRGUP	LIRA	1.206,00	201
WEBK110/91VERCP	VELIS	837,00	54	WEBK204/QBM	MIA	2.336,00	178
WEBK110/91VERTP	VELIS	837,00	54	WEBK204/QCR	RAY	1.557,00	167
WEBK110/91VESB	VELIS	837,00	54	WEBK204/QCR	MIA	1.557,00	178
WEBK110/9ABBM	ABC	894,00	234	WEBK204/QIX	MIA	2.336,00	178
WEBK110/9ABCR	ABC	662,00	234	WEBK204/SOCCR	SOLE	1.182,00	33
WEBK110/9LPCR	LOOP	1.559,00	147	WEBK204/SOGUP	SOLE	1.891,00	33
WEBK110/9QBM	MIA	2.573,00	178	WEBK204/SOIX	SOLE	1.773,00	33
WEBK110/9QCR	MIA	1.715,00	178	WEBK204/SORTP	SOLE	1.891,00	33
WEBK110/9QIX	MIA	2.573,00	178	WEBK204/SOSB	SOLE	1.891,00	33
WEBK110/9SEBM	SEVEN	1.598,00	127	WEBK204/TILRBM	UNO	1.130,00	107
WEBK110/9SECR	SEVEN	1.101,00	127	WEBK204/TILRCR	UNO	754,00	107
WEBK110/9SEIX	SEVEN	1.598,00	127	WEBK204/TBM	LIVE	969,00	87
WEBK110/9SOCCR	SOLE	970,00	33	WEBK204/TCGP	LIVE	1.046,00	87
WEBK110/9SOGUP	SOLE	1.552,00	33	WEBK204/TCR	LIVE	654,00	87
WEBK110/9SOIX	SOLE	1.455,00	33	WEBK204/TGUP	LIVE	1.046,00	87
WEBK110/9SORTP	SOLE	1.552,00	33	WEBK204/TIX	LIVE	969,00	87
WEBK110/9SOSB	SOLE	1.552,00	33	WEBK204/TRTP	LIVE	1.046,00	87
WEBK110/9TBM	LIVE	1.089,00	86	WEBK204/TWM	LIVE	969,00	87
WEBK110/9TCGP	LIVE	1.174,00	86	WEBK204/UPBM	UP	963,00	157
WEBK110/9TCR	LIVE	734,00	86	WEBK204/UPCR	UP	649,00	157
WEBK110/9TGUP	LIVE	1.174,00	86	WEBK204/VECGP	VELIS	1.522,00	53
WEBK110/9TIX	LIVE	1.089,00	86	WEBK204/VECR	VELIS	945,00	53
WEBK110/9TRTP	LIVE	1.174,00	86	WEBK204/VEGUP	VELIS	1.522,00	53
WEBK110/9TWM	LIVE	1.089,00	86	WEBK204/VEIX	VELIS	1.418,00	53
WEBK110/9VECGP	VELIS	1.260,00	52	WEBK204/VERCP	VELIS	1.522,00	53
WEBK110/9VECR	VELIS	777,00	52	WEBK204/VERTP	VELIS	1.522,00	53
WEBK110/9VEGUP	VELIS	1.260,00	52	WEBK204/VESB	VELIS	1.522,00	53
WEBK110/9VEIX	VELIS	1.165,00	52	WESK030/SYCR	SET DOCCIA COMPLETI	320,00	422
WEBK110/9VERCP	VELIS	1.260,00	52	WESK100/SOCCR	SOLE	479,00	36
WEBK110/9VERTP	VELIS	1.260,00	52	WESK100/SOGUP	SOLE	766,00	36
WEBK110/9VESB	VELIS	1.260,00	52	WESK100/SOIX	SOLE	719,00	36
WEBK204/1LRBM	LIRA	1.208,00	201	WESK100/SORTP	SOLE	766,00	36
WEBK204/1LRCR	LIRA	805,00	201	WESK100/SOSB	SOLE	766,00	36
WEBK204/1LRGUP	LIRA	1.288,00	201	WESK100/ITBM	LIVE	645,00	92
WEBK204/1TILRBM	UNO	1.208,00	107	WESK100/ITCGP	LIVE	690,00	92
WEBK204/1TILRCR	UNO	805,00	107	WESK100/ITCR	LIVE	431,00	92

CODICE	COLLEZIONE	EURO	PAG.	CODICE	COLLEZIONE	EURO	PAG.
WESK100/1TGUP	LIVE	690,00	92	YO126118/10CR	YOYO	183,00	117
WESK100/1TIX	LIVE	645,00	92	YO126118/1BM	YOYO	234,00	113
WESK100/1TRTP	LIVE	690,00	92	YO126118/1CR	YOYO	155,00	113
WESK100/1TWM	LIVE	645,00	92	YO126118/2BM	YOYO	254,00	114
WESK100/1VECGP	VELIS	688,00	58	YO126118/2CR	YOYO	169,00	114
WESK100/1VECR	VELIS	431,00	58	YO126118/3BM	YOYO	228,00	114
WESK100/1VEGUP	VELIS	688,00	58	YO126118/3CR	YOYO	152,00	114
WESK100/1VEIX	VELIS	645,00	58	YO126119/1BM	YOYO	234,00	116
WESK100/1VERCP	VELIS	688,00	58	YO126119/1CR	YOYO	155,00	116
WESK100/1VERTP	VELIS	688,00	58	YO126128/2BM	YOYO	473,00	114
WESK100/1VESB	VELIS	688,00	58	YO126128/2CR	YOYO	315,00	114
WESK100/90LPCR	SET DOCCIA COMPLETI	1.490,00	418	YO126130/30BM	COLONNE MONOCOMANDO	1.075,00	402
WESK100/90QCR	SET DOCCIA COMPLETI	1.477,00	419	YO126130/30CR	COLONNE MONOCOMANDO	717,00	402
WESK100/90TCR	SET DOCCIA COMPLETI	1.088,00	418	YO126130/60CR	COLONNE MONOCOMANDO	827,00	403
WESK100/91TCR	SET DOCCIA COMPLETI	1.088,00	417	YO126130BM	YOYO	240,00	117
WESK100/92TCR	SET DOCCIA COMPLETI	1.227,00	417	YO126130CR	YOYO	160,00	117
WESK100/LPCR	LOOP	597,00	151	YO126198/1BM	YOYO	393,00	116
WESK100/QBM	MIA	1.005,00	183	YO126198/1BM	ALLBOX	393,00	292
WESK100/QCR	RAY	670,00	171	YO126198/1CR	YOYO	261,00	116
WESK100/QCR	MIA	670,00	183	YO126198/1CR	ALLBOX	261,00	292
WESK100/QIX	MIA	1.005,00	183	YO126198BM	YOYO	353,00	115
WESK100/TBM	LIVE	645,00	92	YO126198BM	ALLBOX	353,00	291
WESK100/TCGP	LIVE	690,00	92	YO126198CR	YOYO	235,00	115
WESK100/TCR	LIVE	431,00	92	YO126198CR	ALLBOX	235,00	291
WESK100/TGUP	LIVE	690,00	92	YO126338/2BM	YOYO	314,00	115
WESK100/TIX	LIVE	645,00	92	YO126338/2CR	YOYO	210,00	115
WESK100/TRTP	LIVE	690,00	92	YOE126118/1BM	YOYO	235,00	113
WESK100/TWM	LIVE	645,00	92	YOE126118/1CR	YOYO	156,00	113
WESK100/VECGP	VELIS	688,00	58	YOE126118/2BM	YOYO	255,00	113
WESK100/VECR	VELIS	431,00	58	YOE126118/2CR	YOYO	170,00	113
WESK100/VEGUP	VELIS	688,00	58	YOE126118/3BM	YOYO	230,00	113
WESK100/VEIX	VELIS	645,00	58	YOE126118/3CR	YOYO	153,00	113
WESK100/VERCP	VELIS	688,00	58	YOE126119/1BM	YOYO	235,00	116
WESK100/VERTP	VELIS	688,00	58	YOE126119/1CR	YOYO	156,00	116
WESK100/VESB	VELIS	688,00	58	YOE126128/2BM	YOYO	476,00	114
WESK102/1QBM	SET DOCCIA COMPLETI	1.839,00	422	YOE126128/2CR	YOYO	316,00	114
WESK102/1QCR	SET DOCCIA COMPLETI	1.226,00	422				
WESK102/1TBM	SET DOCCIA COMPLETI	1.481,00	420				
WESK102/1TCR	SET DOCCIA COMPLETI	994,00	420				
WESK102/LPCR	SET DOCCIA COMPLETI	1.468,00	421				
WESK102/QCR	SET DOCCIA COMPLETI	1.502,00	421				
WESK102/TCR	SET DOCCIA COMPLETI	1.067,00	419				
WESK102/UPCR	SET DOCCIA COMPLETI	1.049,00	420				
YO126030BM	YOYO	328,00	118				
YO126030BM	TERMOSTATICI ESTERNI	328,00	378				
YO126030CR	YOYO	218,00	118				
YO126030CR	TERMOSTATICI ESTERNI	218,00	378				
YO126100/EBM	YOYO	208,00	118				
YO126100/EBM	EASYBOX	208,00	306				
YO126100/ECR	YOYO	139,00	118				
YO126100/ECR	EASYBOX	139,00	306				
YO126108BM	YOYO	141,00	118				
YO126108CR	YOYO	93,00	118				
YO126110/1BM	YOYO	296,00	117				
YO126110/1CR	YOYO	197,00	117				
YO126110BM	YOYO	417,00	117				
YO126110CR	YOYO	278,00	117				
YO126118/10BM	YOYO	274,00	117				



# CONDIZIONI GENERALI DI VENDITA

Crediamo da sempre in rapporti commerciali dove alla base di ogni trattativa ci siano valori quali fiducia, onestà e serietà, così come crediamo in una metodologia di lavoro qualificata e professionale. Al fine di reperire con la massima facilità tutte le informazioni necessarie al completamento dell'ordine, riportiamo di seguito le Condizioni Generali di Vendita suddivise per singolo argomento.

Le presenti Condizioni Generali di Vendita (d'ora in avanti «CGV») della società Carlo Nobili S.p.A. Rubinetterie (d'ora in avanti «Nobili») si applicano a qualsiasi ordine effettuato a Nobili da parte di un Acquirente professionista (d'ora in avanti «l'Acquirente») per tutte le consegne effettuate in tutti i Paesi in cui Nobili esporta. Qualsiasi ordine di prodotti o di prestazioni di servizio comporta quale condizione essenziale e determinante l'accettazione senza riserve da parte dell'Acquirente delle presenti CGV che costituiscono la base della negoziazione commerciale, in conformità delle disposizioni degli articoli del Codice del commercio in vigore nei vari Paesi, e la relativa rinuncia da parte dell'Acquirente a qualsiasi altra condizione contraria, a tutte le condizioni generali o particolari dell'Acquirente, incluse le eventuali condizioni di acquisto e gli ordini di acquisto, i contratti di riferimento e i contratti di esercizio commerciale, ogni volta che tali condizioni e/o contratti non abbiano ricevuto il preventivo consenso scritto di Nobili. La negoziazione commerciale tra Nobili e l'Acquirente dovrà essere condotta nel reciproco rispetto degli interessi delle Parti con lealtà e buona fede, nonché in osservanza degli articoli del Codice del commercio in vigore nei Paesi in cui Nobili esporta. Nel caso in cui questi ultimi sanciscano l'assoggettamento o il tentativo di assoggettamento a degli obblighi che originano un disequilibrio significativo nei diritti e obblighi delle Parti, Nobili non potrà in alcun caso accordare vantaggi commerciali o condizioni di vendita particolari che non siano oggetto di una contropartita equivalente ed equilibrata da parte dell'Acquirente. Le presenti CGV sono modificabili in qualsiasi momento, fermo restando che qualsiasi eventuale modifica sarà notificata all'Acquirente e che essa entrerà in vigore un (1) mese dal ricevimento della notifica.

## PREZZI

I prezzi indicati nel presente Listino prezzi al pubblico sono indicativi e destinati ai grossisti. Essi si intendono al netto delle imposte e sono espressi in Euro "franco fabbrica". Tale Listino prezzi annulla e sostituisce tutte le edizioni precedenti, fatti salvi errori ed omissioni. Il Listino prezzi al pubblico rappresenta lo strumento di riferimento più aggiornato. Eventuali errori di tale Listino prezzi al pubblico non costituiscono motivo di reclamo. Qualsiasi ordine effettuato comporta l'accettazione di tutte le condizioni di vendita riportate di seguito. Nobili si riserva il diritto di aumentare i prezzi in qualsiasi momento, in particolare in caso di aumento dei costi di produzione legati ad un aumento del prezzo delle materie prime. I nuovi listini prezzi saranno comunicati all'Acquirente su richiesta. In questo caso, i nuovi listini prezzi saranno inviati all'Acquirente due (2) mesi prima dell'entrata in vigore. Agli ordini inferiori a 100,00 € al netto delle imposte saranno associate le corrispondenti spese di elaborazione dell'ordine (che includono l'inserimento, la preparazione e la spedizione dell'ordine) pari a 30 €. Le spese aggiuntive derivanti da spedizioni tramite corriere espresso restano a carico dell'Acquirente.

## PRODOTTI

1. I prodotti oggetto delle presenti CGV sono definiti con riferimento ai cataloghi di Nobili. Tuttavia, questi ultimi non possono in alcun caso costituire documenti contrattuali. Tutte le informazioni riportate nei cataloghi, nelle brochures e nei listini prezzi sono fornite a titolo indicativo e impegnano la società Nobili soltanto previa conferma scritta da parte della stessa.

2. I prodotti sono fabbricati con la massima accuratezza possibile, fermo restando le tolleranze in uso nel settore in questione. Nobili si riserva la possibilità di modificare in modo unilaterale le caratteristiche dei prodotti venduti in base ai miglioramenti raccomandati dai propri servizi, e questo senza obbligo da parte sua di modificare i prodotti consegnati in precedenza o i prodotti in corso d'ordine, e senza che le stampe, le descrizioni e le informazioni riportate a titolo pubblicitario sui documenti commerciali di Nobili possano essere contestate all'azienda.

## ORDINI

Gli ordini sono subordinati all'accettazione di Nobili e si intendono subordinati alla totalità delle condizioni di vendita stabilite. Gli ordini si intendono accettati ai prezzi e alle condizioni in vigore alla data dell'ordine e l'accettazione è subordinata al benessere di Nobili. Gli ordini e le modifiche comunicati verbalmente e per telefono dovranno essere confermati dal cliente tramite posta, fax o e-mail. Eventuali annullamenti potranno essere autorizzati soltanto previo benessere scritto di Nobili, che si riserva di applicare le penali che ne potrebbero conseguire o si riserva il diritto di rifiutarli. Nobili non accetta ordini inferiori a 100,00 € franco netto scontato. Per importi inferiori Nobili fatturerà 25,00 € di spese di trasporto per il servizio standard e 40,00 € per il servizio Express Saver consegna in 24 ore. Il cliente dovrà confermare per iscritto se desidera utilizzare questo servizio speciale. Un importo aggiuntivo di 30,00 € sarà fatturato per le spese di gestione. Nobili si riserva il diritto di richiedere all'Acquirente il pagamento anticipato dell'ordine. L'ordine sarà considerato certo e definitivo soltanto successivamente all'incasso da parte di Nobili del prezzo fatturato. Infine, Nobili si riserva il diritto di richiedere, anche in corso di esecuzione degli impegni dell'Acquirente, qualsiasi rifiuto che autorizzi l'annullamento di tutti o di una parte degli ordini effettuati.

## **CONSEGNE, TRASPORTO, TRASFERIMENTO DEI RISCHI**

1. Salvo se non diversamente specificato, la consegna sarà effettuata all'indirizzo indicato dall'Acquirente al momento dell'ordine. Indipendentemente dalla modalità di spedizione dei prodotti, e in deroga alla clausola di riserva di proprietà stabilita nelle CGV di cui in appresso, i rischi e pericoli sono trasferiti all'Acquirente al momento della consegna fisica delle merci al primo trasportatore. Se la spedizione subisce ritardi a causa del comportamento dell'Acquirente o per una causa indipendente dalla volontà di Nobili, il trasferimento dei rischi avverrà al momento della comunicazione da parte dell'Acquirente di una notifica di fornitura dei prodotti.

2. I ritardi di consegna menzionati nella conferma dell'ordine sono forniti esclusivamente a titolo indicativo in funzione delle disponibilità dei prodotti e del trasporto, a meno che non venga espressamente menzionato che tali ritardi hanno natura tassativa.

3. I termini di consegna eventualmente accettati da Nobili sono di pieno diritto sospesi in seguito a qualsiasi evento che esuli dal controllo di Nobili e che provochi un ritardo nella consegna, ed in particolare in casi di forza maggiore. La forza maggiore designa qualsiasi evento indipendente dalla volontà di Nobili o di uno dei suoi fornitori, prevedibile e inarrestabile, di qualsivoglia natura, catastrofe naturale, pandemia, intemperie, sabotaggio, embargo, sciopero, interruzione o ritardo nei trasporti o nell'approvvigionamento di materie prime, energia o componenti, incidenti delle macchine utensili, che ha l'effetto di rendere il contratto ineseguibile in modo temporaneo o definitivo. L'elenco dei casi di forza maggiore non è limitativo. Nobili informerà l'Acquirente in caso di sopravvenienza di un evento di forza maggiore. In questo caso, i termini di consegna indicati saranno automaticamente prorogati in misura proporzionale. Qualora, nonostante i propri sforzi, Nobili si trovi nell'impossibilità di consegnare le merci ordinate per cause di forza maggiore, Nobili sarà esonerata dal proprio obbligo di consegna.

4. In nessun caso i ritardi di consegna possono chiamare in causa la responsabilità di Nobili. Pertanto, i ritardi di consegna non potranno dar luogo né a penali, né a risarcimenti, né ad annullamenti degli ordini, né a rifiuti di consegna, né tanto meno a sospensioni dei pagamenti delle fatture, salvo preventivo accordo scritto fornito da Nobili, e questo nonostante l'esistenza di clausole contrarie nelle eventuali condizioni di acquisto dell'Acquirente. In ogni caso, soltanto il pregiudizio realmente patito dall'Acquirente, dimostrato e valutato, potrà essere oggetto di una domanda di risarcimento la quale potrà, ad ogni modo, essere presentata soltanto previa negoziazione con Nobili e accordo tra le parti. In caso di mancato accordo, la stima del pregiudizio subito sarà stabilita da un perito incaricato dal Tribunale del commercio di Novara, su richiesta della parte più diligente.

5. Nobili è autorizzata a procedere, prima dello scadere del termine di consegna previsto e in proporzioni ragionevoli, a consegne e fatturazioni parziali.

6. Nel caso in cui la consegna sia ritardata su richiesta dell'Acquirente, le spese di immagazzinaggio e gli attuali interessi sul capitale investito per consentire l'immagazzinaggio saranno fatturati da Nobili per un ammontare minimo, per ciascun mese di ritardo, dell'1% calcolato sull'importo della fattura tasse escluse. Allo scadere del termine ulteriore fissato tra le Parti, Nobili si riserva il diritto di disporre dei prodotti e di garantire la consegna di altri prodotti equivalenti entro un termine adeguato prorogato. Qualsiasi modifica di un ordine che sopraggiunga in corso di esecuzione, anche se accettata da Nobili, comporta una proroga del termine di consegna previsto secondo le modalità comunicate da Nobili all'Acquirente.

7. Spetta all'Acquirente verificare i prodotti al momento del ricevimento ed esprimere immediatamente qualsiasi riserva utile secondo le condizioni previste nelle presenti CGV. Qualsiasi reclamo sarà preso in considerazione soltanto se la merce si trova ancora nel medesimo stato in cui è stata consegnata.

8. Per gli articoli con finitura speciale e non disponibili a magazzino, il tempo indicativo previsto per la consegna è di otto settimane franco fabbrica.

## **ESCLUSIONE DI PENALI**

Dal momento che le penali sono destinate a rimediare a un pregiudizio risultante da una violazione di un obbligo contrattuale, Nobili rifiuta la fatturazione sistematica ed arbitraria di penali predeterminate dall'Acquirente che, per propria natura, non sono proporzionali al pregiudizio eventualmente patito da quest'ultimo, e ciò nonostante tutte le clausole e disposizioni contrarie che potrebbero essere indicate in condizioni di acquisto, piani economico-finanziari annui, contratti di riferimento, condizioni logistiche, ecc. da parte dell'Acquirente. Di conseguenza, nessuna penale di qualsivoglia natura potrà essere fatturata o detratta dall'Acquirente da un saldo di prodotti senza che Nobili abbia potuto verificare la sussistenza della violazione e del pregiudizio invocati dall'Acquirente in forza degli articoli dei Codici del commercio in vigore nei vari Paesi in cui Nobili esporta, e senza che Nobili abbia fornito il proprio preventivo consenso scritto al riguardo. A tal fine, l'Acquirente dovrà fornire a Nobili tutti i documenti finalizzati a consentire un'analisi comparativa della violazione invocata e attestante il pregiudizio realmente patito. Nobili disporrà di un termine sufficiente per analizzare i documenti

inviati e informare l'Acquirente in merito al proprio accordo o disaccordo circa la violazione invocata e l'entità del risarcimento richiesto. Qualsiasi addebito diretto da parte dell'Acquirente in violazione delle presenti disposizioni sarà assimilato a un incidente di pagamento che autorizzerà Nobili a rifiutare qualsiasi nuovo ordine di prodotti e a sospendere qualsiasi consegna in corso dopo averne dato notizia all'Acquirente, o a sospendere il saldo di ristorni e altri vantaggi finanziari, finanche a chiudere il conto dell'Acquirente. Nobili si riserva il diritto di detrarre ristorni o qualsiasi altro pagamento dovuto all'Acquirente o qualsiasi importo che l'Acquirente abbia detratto d'ufficio senza il preventivo benestare scritto di Nobili.

## **CLAUSOLE DI RISERVA DI PROPRIETÀ**

Le nostre vendite sono perfezionate alla consegna delle merci, tuttavia la proprietà sarà trasferita all'Acquirente soltanto successivamente al pagamento effettivo e completo della fattura. Il trasferimento dei rischi ha luogo al momento della consegna e l'Acquirente deve garantire le merci contro qualsiasi rischio, inclusi quelli di caso fortuito o di forza maggiore. L'Acquirente e il suo assicuratore rinunciano anticipatamente a qualsiasi ricorso nei confronti di Nobili. Nobili autorizza la rivendita del materiale consegnato prima del pagamento integrale del prezzo, ma senza per questo rinunciare all'esercizio del proprio diritto di proprietà. Pertanto, Nobili si riserva il diritto di riprendersi, in caso di mancato pagamento di tutto o di una parte del prezzo esigibile o diventato esigibile, il materiale a marchio proprio ancora esistente in giacenza al momento dell'inadempienza. Tale ripresa del materiale potrà avvenire per qualsiasi elemento in giacenza proveniente da Nobili, anche se il materiale ripreso non era quello oggetto del mancato pagamento. In mancanza di materiale ancora esistente in giacenza presso l'Acquirente, Nobili potrà cercare, con qualsiasi mezzo che essa riterrà opportuno, subacquirenti delle proprie merci o domandare a questi il saldo della cessione del credito dovuto dal debitore principale a favore di Nobili, essendo acquisito d'ufficio in caso di applicazione della presente clausola.

Qualora il materiale di Nobili sia rivenduto insieme ad altre merci che non appartengono a Nobili, il nostro cliente è considerato come aver ceduto a Nobili il proprio credito, ma a debita concorrenza soltanto dell'importo del prezzo o della parte del prezzo delle merci di Nobili ancora non saldati. In caso di mancato pagamento di tutto o di una parte del prezzo alla scadenza stabilita, Nobili avrà la facoltà, a propria esclusiva discrezione e previa semplice notifica, di esercitare il proprio diritto di rivendicazione che comporterà la decadenza di qualsiasi termine consentito, il pagamento di interessi di ritardo dovuti automaticamente a decorrere dalla data di scadenza e senza necessità di ingiunzione alcuna, calcolati al tasso di interesse legale maggiorato del 50%, nonché l'esigibilità di tutte le spese di qualsiasi natura sostenute per giungere alla ripresa effettiva della merce, la vendita essendo risolta alle condizioni di cui in appresso soltanto in caso di inadempimento da parte dell'Acquirente all'ottemperanza dei propri obblighi. In alternativa Nobili potrà avvalersi della risoluzione di vendita 3 giorni dopo l'invio di una raccomandata con ricevuta di ritorno notificante all'Acquirente l'ingiunzione al pagamento del prezzo o del saldo del prezzo, gli interessi e le spese come sopra enunciati, rimasta senza effetto, o ancora di avvalersi di tale risoluzione per il semplice fatto che l'esercizio della rivendicazione non si è tradotto nell'esecuzione degli obblighi incombenti sull'Acquirente. In tutti i casi di risoluzione, gli anticipi resteranno acquisiti da Nobili sia a titolo di deprezzamento dei prodotti sia a titolo di clausola penale e fermo restando qualsiasi altro risarcimento, se del caso, in particolare in ragione di iniziative e diligenze amichevoli o che saranno state necessarie al recupero.

## **DATI IDENTIFICATIVI DEL CLIENTE**

Il cliente è responsabile di tutti i dati identificativi forniti a Carlo Nobili S.p.A. Rubinetterie come ad esempio: ragione sociale, sede legale, partita IVA insieme a tutti gli altri dati richiesti specificatamente dalla legislazione vigente. I dati del cliente, ai sensi delle leggi in vigore nei diversi Paesi in cui Nobili esporta, saranno conservati ed elaborati ai fini dell'assolvimento degli obblighi di legge. Tutti gli altri utilizzi dovranno essere accettati dal cliente.

## **IMBALLAGGIO E SPEDIZIONE**

Gli imballaggi sono preparati da personale specializzato. Carlo Nobili S.p.A. Rubinetterie declina qualsiasi responsabilità. Le merci viaggiano a rischio e pericolo del cliente. Il destinatario è tenuto a controllare le merci consegnate e a contestare tempestivamente ai trasportatori gli eventuali danni contestualmente al ricevimento della merce e ad informare Nobili tramite raccomandata A.R. (anche se questi sono stati scelti da Carlo Nobili S.p.A. Rubinetterie). Salvo accordi diversi, le spese di trasporto restano a carico del cliente.

## **PAGAMENTO E RITARDI**

1. Ogni consegna successiva a un ordine dell'Acquirente dà luogo all'emissione di una fattura. Le fatture sono pagabili a Nobili Italia entro quarantacinque (45) giorni dalla data della fattura, tramite bonifico bancario, salvo condizioni particolari concordate tra Nobili e l'Acquirente. Tutti i pagamenti saranno effettuati al netto delle commissioni. In caso di pagamento tramite assegno, l'Acquirente si farà carico delle spese di sconto, di incasso nonché di qualsiasi altra spesa bancaria. I pagamenti verranno imputati innanzi tutti sui costi, quindi sugli interessi e, infine, sui crediti principali di più antica data.

2. In caso di mancato pagamento alla scadenza, in forza degli articoli del Codice del commercio in vigore nei vari Paesi in cui Nobili esporta, saranno esigibili a pieno titolo e senza preavviso interessi di ritardo calcolati sulla base del tre (3) per cento del tasso di interesse legale e al minimo del nove (9) per cento annuo, a pieno titolo e senza richiamo, il giorno successivo alla data di scadenza indicata sulla fattura fino al giorno del saldo completo.

3. Il mancato pagamento, anche parziale, di una sola delle scadenze concordate per una qualsiasi delle consegne comporterà inoltre la decadenza del termine della totalità delle scadenze in corso.

4. In nessun caso i pagamenti dovuti a Nobili potranno essere sospesi né essere oggetto di una qualsiasi riduzione o compensazione su iniziativa esclusiva dell'Acquirente, essendo indispensabile il preventivo benestare scritto di Nobili, e ciò indipendentemente dalle eventuali disposizioni contrarie che potrebbero essere incluse nelle condizioni di acquisto dell'Acquirente. Qualsiasi compensazione non autorizzata da Nobili sarà assimilata a un

mancato pagamento che autorizzerà Nobili a rifiutare qualsiasi nuovo ordine di prodotti nonché a sospendere le consegne in corso.

5. In caso di ritardo o di mancanza di pagamento nonostante l'invio delle ingiunzioni, Nobili si riserva il diritto, in relazione a qualsiasi ordine futuro, di esigere garanzie di pagamento nonché di esigere che la consegna della merce ordinata avvenga soltanto dietro pagamento integrale dell'ordine. Le ingiunzioni di pagamento restano senza effetto, Nobili potrà chiedere la revoca della vendita, esigere il pagamento immediato delle merci consegnate, sospendere qualsiasi consegna e/o annullare qualsiasi ordine in corso fino al saldo completo di tutte le somme dovute. In caso di revoca, l'Acquirente dovrà rimborsare a Nobili tutti i costi legati alla conclusione del contratto come anche il mancato guadagno. In caso di mancato pagamento totale o parziale anche soltanto di una scadenza, Nobili potrà procedere al recupero delle merci vendute fatta salva la proprietà in forza delle disposizioni previste al pertinente paragrafo delle CGV.

## **RESPONSABILITÀ**

Tutti gli articoli di nostra produzione sono accuratamente controllati. I danni provocati da un'errata installazione o un uso improprio non sono coperti dalla garanzia, salvo accordo specifico tra Nobili e l'Acquirente. Nobili non accetta resi della merce. Tuttavia, in caso di reso autorizzato, tale reso dovrà essere franco a carico del cliente. Se il materiale è realmente difettoso, la responsabilità di Nobili si limita alla sostituzione delle parti, senza alcun risarcimento per eventuali danni diretti e indiretti causati dall'impiego dei nostri prodotti. È fatto divieto ai clienti di eseguire qualsiasi tipo di intervento meccanico sui prodotti di nostra produzione.

## **RECLAMI**

I reclami dovranno essere inviati entro otto giorni dal ricevimento della merce con conferma scritta. Qualsiasi tipo di reso del materiale dovrà essere approvato per iscritto dalla nostra direzione commerciale dietro presentazione dell'elenco dei materiali con la motivazione del reso, utilizzando la scheda Nobili reperibile sul sito [www.nobili.it](http://www.nobili.it). Le spese di reso sono a carico del cliente salvo accordo specifico tra la direzione commerciale di Nobili e l'Acquirente. In caso di reso di un prodotto nuovo e inutilizzato ordinato per errore, il reso sarà a carico del cliente e la società Nobili applicherà una detrazione del 50% del valore del prodotto fatturato al momento della prima spedizione.

## **CONTESTAZIONI**

Il Tribunale di Novara avrà la competenza giuridica esclusiva a risolvere qualsiasi controversia che potrebbe insorgere.

## **GARANZIA**

Tutti i prodotti Carlo Nobili S.p.A. Rubinetterie sono subordinati a controlli in ogni fase del processo di produzione e sono garantiti per un periodo di 5 anni dalla data di acquisto, 2 anni di garanzia Europea più 3 anni di estensione gratuita offerta da Nobili (farà fede la data della fattura). In assenza di fattura, l'installazione sarà ritenuta avvenuta al massimo entro 4 settimane dalla consegna dei nostri prodotti all'Acquirente. I prodotti colorati e quelli elettronici sono garantiti 2 anni. Le parti di ricambio sono garantite 2 anni. Le cartucce Nobili Widd® 35 e Nobili Widd® 28 sono garantite 20 anni. I prodotti standard o campione ordinati in condizioni di Expo potranno essere oggetto di richiesta di ammanchi esclusivamente a condizione che la richiesta sia ricevuta da Nobili entro sette (7) giorni di calendario dalla data di consegna al cliente, e in ogni caso subordinatamente a convalida da parte del nostro servizio tecnico. La garanzia Nobili non è rinnovabile.

I casi elencati di seguito sono coperti dalla garanzia:

- Difetti di fusione, di porosità e di cromatura
- Riparazione o sostituzione di prodotti con difetti di fabbricazione riconosciuti dal nostro ufficio tecnico

Di contro, la garanzia non interverrà nei casi seguenti:

- Errori di installazione e applicazione del prodotto
- Deterioramento delle superfici cromate dovuto all'utilizzo di prodotti di pulizia contenenti acidi e sostanze abrasive
- Presenza di corpi estranei veicolati dall'acqua (sabbia, limatura)
- Deterioramento delle superfici presentanti finiture diverse da quelle cromate. La durata dei prodotti è subordinata alla cura e alla delicatezza di utilizzo
- Deterioramento della rubinetteria dovuto a un'installazione impropria
- Utilizzo improprio del prodotto
- Riparazioni e manutenzioni effettuate in modo improprio e senza preventiva autorizzazione di Nobili

## **PULIZIA**

Si raccomanda di risciacquare e asciugare costantemente il rubinetto, onde evitare depositi di calcare esteticamente sgradevoli: nel caso si riscontrasse presenza di calcare sulla superficie del prodotto, è possibile dissolverla con aceto diluito (concentrazione massima 10% a 20°C) e successivamente risciacquare con acqua pulita. Per maggiori informazioni invitiamo a consultare il nostro sito web: [nobili.it](http://nobili.it) / [supporto](#) / [cura e manutenzione](#)



# ANNOTAZIONI

Un piccolo spazio per grandi idee, utile per prendere nota su informazioni commerciali, caratteristiche di prodotto, oppure realizzare bozze di progetto direttamente su questo volume, in modo da averle sempre a portata di mano. Un supporto universale da utilizzare a seconda delle singole necessità, che aiuta a non perdere nessun dato indispensabile per il professionista.





# CARLO NOBILI SPA RUBINETTERIE

VIA NOVARA 29  
28019 SUNO (NO) ITALIA  
NOBILI.IT

## **CREATIVE DIRECTION**

MARCO VENZANO  
CECILIA GIORDANO

## **DATA INTEGRATION**

GIANNI PRIORI

## **ORGANIZZAZIONE COMMERCIALE**

# CARLO NOBILI SPA RUBINETTERIE

VIA NOVARA 29  
28019 SUNO (NO) ITALIA  
NOBILI.IT

## **CREATIVE DIRECTION**

MARCO VENZANO  
CECILIA GIORDANO

## **DATA INTEGRATION**

GIANNI PRIORI

## ORGANIZZAZIONE COMMERCIALE

Ci prendiamo cura dei nostri clienti attraverso una rete vendita qualificata e distribuita su tutto il territorio nazionale, oltre ad una diversificata e strutturata assistenza post vendita: personale preparato e disponibile per rendere semplice e piacevole qualsiasi esperienza d'acquisto.

### VALLE D'AOSTA, PIEMONTE

- 📍 AO, AL, AT, BI, CN, NO, TO, VB, VC
- 📞 Andrea Pastore (area manager Michele Minazzoli)
- ☎ 349 3296901
- ✉ a.pastore@nobili.it

### LOMBARDIA

- 📍 BG, BS, CO, CR, LC, LO, MN, MI, MB, PV, SO, VA
- 📞 Filippo Pasquino
- ☎ 342 6703874
- ✉ f.pasquino@nobili.it

### TRENTINO ALTO ADIGE

- 📍 BZ, TN
- 📞 Giuseppe Sanna (area manager Michele Minazzoli)
- ☎ 335 6544506
- ✉ agenzia.sannagiuseppe@gmail.com

### VENETO

- 📍 BL, VI, VR
- 📞 Giuseppe Sanna (area manager Michele Minazzoli)
- ☎ 335 6544506
- ✉ agenzia.sannagiuseppe@gmail.com

### VENETO

- 📍 PD, RO, TV, VE
- 📞 Tommaso Nobili (area manager Michele Minazzoli)
- ☎ 335 225294
- ✉ tommaso.nobili@hotmail.it

### FRIULI-VENEZIA GIULIA

- 📍 GO, PN, TS, UD
- 📞 Tommaso Nobili (area manager Michele Minazzoli)
- ☎ 335 225294
- ✉ tommaso.nobili@hotmail.it

### LIGURIA

- 📍 GE, IM, SP, SV
- 📞 Andrea Pastore (area manager Michele Minazzoli)
- ☎ 349 3296901
- ✉ a.pastore@nobili.it

### TOSCANA

- 📍 AR, FI, GR, LI, LU, MS, PI, PT, PO, SI
- 📞 Lorenzo Ariani
- ☎ 348 7819661
- ✉ mail@lorenzoariani.com

### EMILIA ROMAGNA

- 📍 BO, FE, MO, PR, PC, RE
- 📞 Agenzia Boretti
- ☎ 0523 331084
- ✉ info@boretthisas.it

### EMILIA ROMAGNA

- 📍 FC, RA, RN
- 📞 Eurostrada S.r.l.
- ☎ 0549 909715
- ✉ ordini@eurostrada.sm

### MARCHE

- 📍 AN, AP, FM, MC, PU (clienti diretti)
- 📞 Giovanni Antonucci
- ☎ 348 2874964
- ✉ giovanniantonuccimail@gmail.com

### MARCHE

- 📍 AN, AP, FM, MC, PU (clienti direzionali)
- 📞 Piero Lamperti
- ☎ 348 2874961
- ✉ pierolampertimail@gmail.com

### UMBRIA

- 📍 PG, TR
- 📞 Alessandro Chierico
- ☎ 335 6087492
- ✉ a.chierico@cir-sas.com

### LAZIO

- 📍 RI, VT
- 📞 Alessandro Chierico
- ☎ 335 6087492
- ✉ a.chierico@cir-sas.com

### LAZIO

- 📍 FR, LT, RM
- 📞 Ilio Zappone
- ☎ 339 6739543
- ✉ ilio.zappone@izrappresentanze.it

### ABRUZZO, MOLISE

- 📍 CH, AQ, PE, TE, CB, IS (clienti diretti)
- 📞 Giovanni Antonucci
- ☎ 348 2874964
- ✉ giovanniantonuccimail@gmail.com

### ABRUZZO, MOLISE

- 📍 CH, AQ, PE, TE, CB, IS (clienti direzionali)
- 📞 Piero Lamperti
- ☎ 348 2874961
- ✉ pierolampertimail@gmail.com

### CAMPANIA

- 📍 AV, BN, CE, NA, SA
- 📞 Lorenzo Sforza
- ☎ 340 7065830 ☎ 081 3192343
- ✉ segreteriasforzasnc@gmail.com

### CAMPANIA

- 📍 AV, BN, CE, NA, SA
- 📞 Salvatore Sforza
- ☎ 348 2262050 ☎ 081 3192343
- ✉ segreteriasforzasnc@gmail.com

### PUGLIA

- 📍 BA, BT, FG
- 📞 Gaetano Cappiello
- ☎ 335 8450069
- ✉ gaesrll@gmail.com

### PUGLIA

- 📍 BR, LE, TA
- 📞 Giuseppe Goffredo
- ☎ 393 9252376
- ✉ pippogoffredo70@gmail.com

### BASILICATA

- 📍 MT, PZ
- 📞 Lorenzo Sforza
- ☎ 340 7065830 ☎ 081 3192343
- ✉ segreteriasforzasnc@gmail.com

### CALABRIA

- 📍 CZ, CS, KR, RC, VV
- 📞 Ferraro S.a.s. di Aldo Ferraro
- ☎ 0984 462728 ☎ 340 3676978
- ✉ info@ferrarorappresentanze.com

### SICILIA

- 📍 AG, CL, PA, TP
- 📞 Dario Mazza
- ☎ 091 6452677 ☎ 336 696000
- ✉ info@dariomazzarappresentanze.it

### SICILIA

- 📍 CT, EN, ME, RG, SR
- 📞 Sergio Puglisi
- ☎ 347 5244443
- ✉ info@puglisirappresentanze.it

### SARDEGNA

- 📍 CA, NU, OR, SS, SU
- 📞 Franco Gonanu
- ☎ 329 6292832
- ✉ f.gonanu@gmail.com

### SARDEGNA

- 📍 CA, NU, OR, SS, SU
- 📞 Marco Barcaro
- ☎ 348 2700314
- ✉ barcarorapp@gmail.com

### RESPONSABILE COMMERCIALE

- 📞 Matias Viola
- ☎ 335 5267500
- ✉ m.viola@nobili.it

### AREA MANAGER

- 📞 Michele Minazzoli
- ☎ 345 9337603
- ✉ m.minazzoli@nobili.it

### RESPONSABILE BACK OFFICE

- 📞 Martina Pastore
- ☎ 0322 885858
- ✉ m.pastore@nobili.it

### INFORMAZIONI COMMERCIALI, SPEDIZIONI

- 📞 Monica Rachi
- ☎ 0322 885859
- ✉ m.rachi@nobili.it

### CONTABILITÀ CLIENTI

- 📞 Elisa Cavallieri
- ☎ 0322 844555 / 1
- ☎ 0322 846489
- ✉ e.cavallieri@nobili.it

### RICEZIONE ORDINI

- ✉ ordini\_ita@nobili.it

### CONSEGNA RAPIDA SALA MOSTRA

- ✉ salamostra@nobili.it

### AREA MANAGER CUCINA

- 📞 Andrea Fava Piz
- ☎ 340 2699748
- ✉ a.favapiz@nobili.it

### SUPPORTO TECNICO

- 📞 Alessandro Sacchi
- ☎ 0322 885881
- ✉ supporto@nobili.it
- 🔗 nobili.it/it/supporto/scrivici



# NOBILI

ACATALIST2024 / Aprile 2024 / Investiamo risorse nel miglioramento continuo del prodotto e delle metodologie di lavorazione. Il catalogo può contenere articoli soggetti a modifiche. A seguito della stampa, la presentazione delle finiture potrebbe non corrispondere pienamente alla realtà. Prima della stesura dell'ordine, consigliamo di consultare la nostra rete vendita.

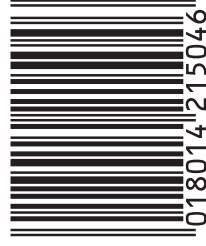

8 018014 215046